

soflight[®]

2023

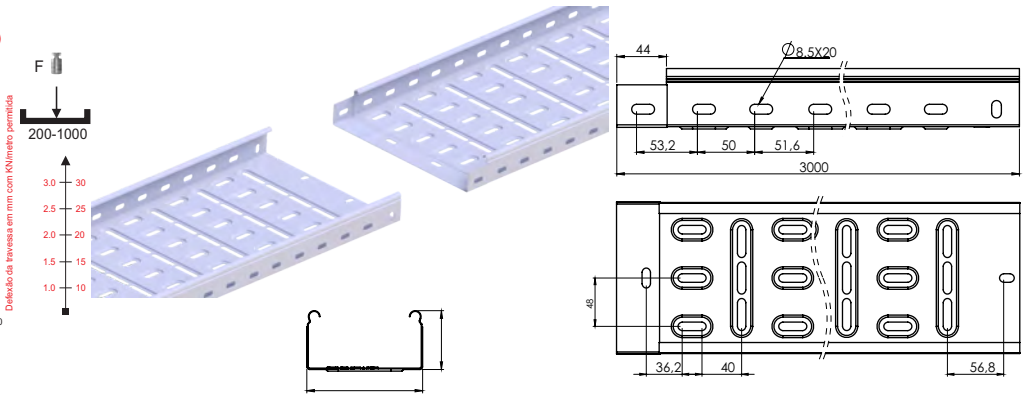

Caminho Cabos Perfurado com Aba 40mm, com União Rápida Acabamento: Sendzimir - EN 10346

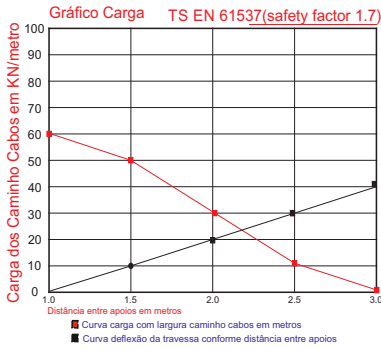

Código	mm	mm	mm	mm	kg/mt	Acabamento	P.U./mt €	
CC-050-40-06-PG	50mm	40mm	3000mm	0,6mm	0,620kg/mt	SENDZIMIR	6,28€	●
CC-100-40-06-PG	100mm	40mm	3000mm	0,6mm	0,857kg/mt	SENDZIMIR	6,35€	●
CC-150-40-06-PG	150mm	40mm	3000mm	0,6mm	1,065kg/mt	SENDZIMIR	6,72€	●
CC-200-40-06-PG	200mm	40mm	3000mm	0,6mm	1.280kg/mt	SENDZIMIR	7,80€	●
CC-300-40-08-PG	300mm	40mm	3000mm	0,8mm	2.280kg/mt	SENDZIMIR	13,73€	●

- Artigo de stock habitual
- Artigo disponível por encomenda

Caminho Cabos Perfurado com Aba 60mm, com União Rápida Acabamento: Sendzimir - EN 10346

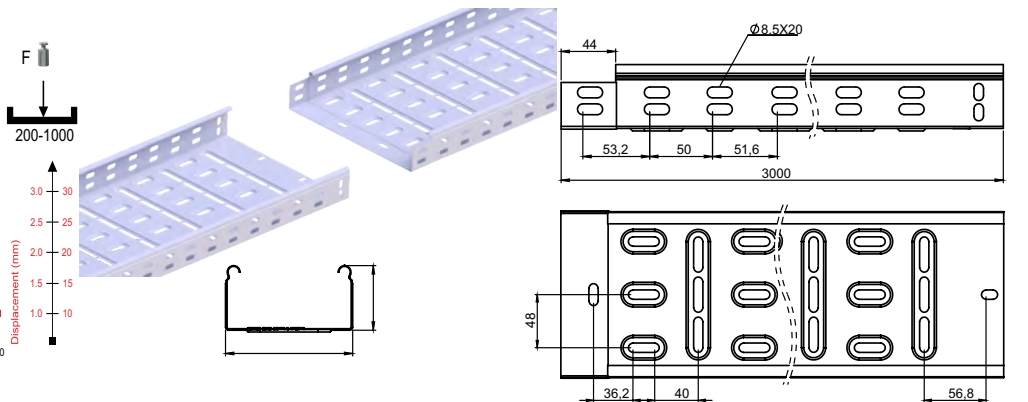
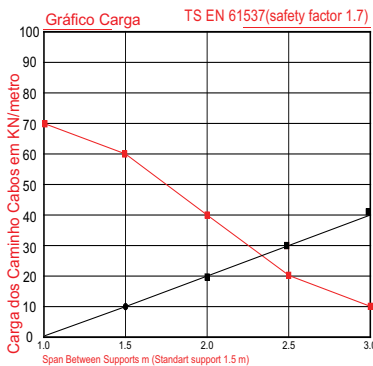

Código	mm	mm	mm	mm	kg/mt	Acabamento	P.U./mt €	
CC-050-50-06-PG	50mm	50mm	3000mm	0,6mm	0,710kg/mt	SENDZIMIR	6,30€	●
CC-100-60-06-PG	100mm	60mm	3000mm	0,6mm	1,000kg/mt	SENDZIMIR	6,40€	●
CC-150-60-06-PG	150mm	60mm	3000mm	0,6mm	1,220kg/mt	SENDZIMIR	8,17€	●
CC-200-60-06-PG	200mm	60mm	3000mm	0,6mm	1,440kg/mt	SENDZIMIR	9,13€	●
CC-300-60-08-PG	300mm	60mm	3000mm	0,8mm	2,490kg/mt	SENDZIMIR	15,16€	●
CC-400-60-09-PG	400mm	60mm	3000mm	0,9mm	3,450kg/mt	SENDZIMIR	21,30€	●
CC-500-60-10-PG	500mm	60mm	3000mm	1,0mm	4,210kg/mt	SENDZIMIR	28,00€	●
CC-600-60-10-PG	600mm	60mm	3000mm	1,0mm	4,860kg/mt	SENDZIMIR	32,46€	●

- Artigo de stock habitual
- Artigo disponível por encomenda

Caminho Cabos Perfurado com Aba 100mm, com União Rápida
Acabamento: Sendzimir - EN 10346
Acabamento: Galvanizado a Quente - EN 1461

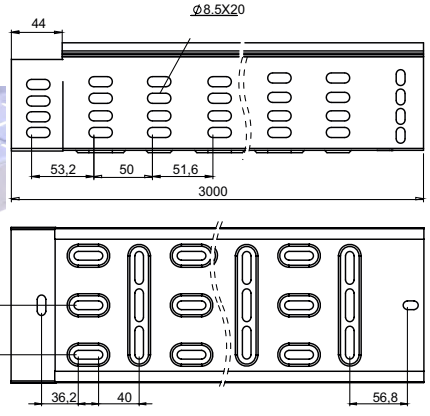
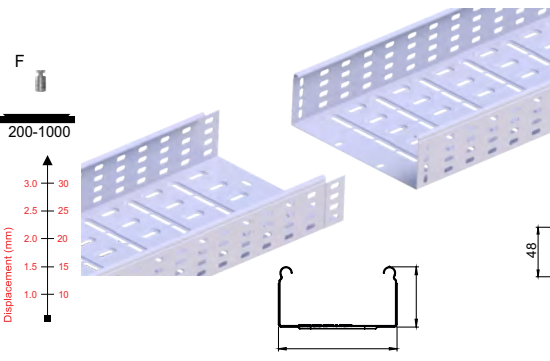
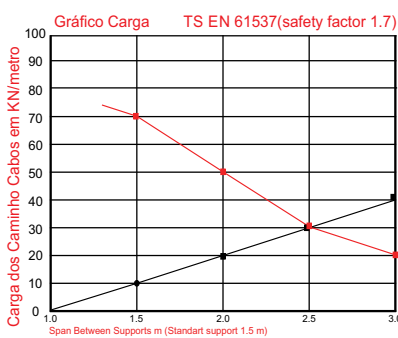

mm	mm	mm	mm	kg/mt	Código(Galvanizado Quente)	P.U./mt €	Código(Sendzimir)	P.U./mt €
100mm	100mm	3000mm	0,7mm	1,330kg/mt	CC-100-100-07-HDG	36,50€	CC-100-100-07-PG	23,00€
150mm	100mm	3000mm	0,7mm	1,580kg/mt	CC-150-100-07-HDG	43,25€	CC-150-100-07-PG	24,00€
200mm	100mm	3000mm	0,8mm	2,090kg/mt	CC-200-100-08-HDG	49,80€	CC-200-100-08-PG	27,80€
300mm	100mm	3000mm	0,9mm	2,990kg/mt	CC-300-100-09-HDG	74,80€	CC-300-100-09-PG	42,00€
400mm	100mm	3000mm	0,9mm	3,650kg/mt	CC-400-100-09-HDG	88,90€	CC-400-100-09-PG	55,00€
500mm	100mm	3000mm	1,2mm	5,100kg/mt	CC-500-100-12-HDG	102,50€	CC-500-100-12-PG	62,50€
600mm	100mm	3000mm	1,2mm	5,800kg/mt	CC-600-100-12-HDG	113,95€	CC-600-100-12-PG	68,15€

- Artigo de stock habitual
- Artigo disponível por encomenda

Caminho Cabos Não Perfurado com Aba 60mm, com União Rápida
Acabamento: Sendzimir - EN 10346
Acabamento: Galvanizado a Quente - EN 1461

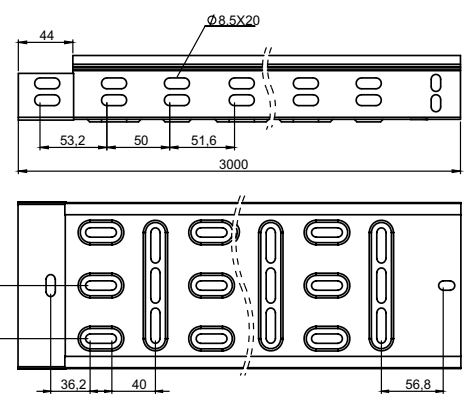
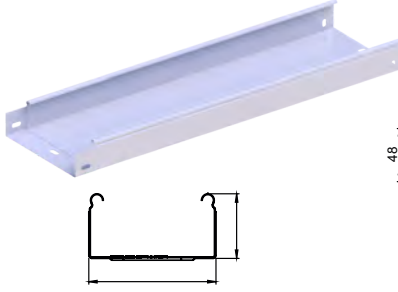
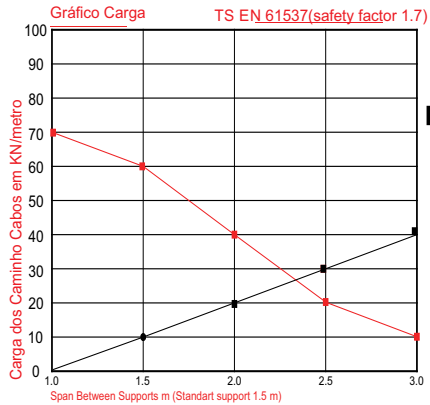

mm	mm	mm	mm	kg/mt	Código(Galvanizado Quente)	P.U./mt €	Código Sendzimir	P.U./mt €
50mm	50mm	3000mm	0,6mm	0,710kg/mt	CC-050-50-06-NP-HDG	16,90€	CC-050-50-06-NP-PG	8,90€
100mm	60mm	3000mm	0,6mm	1,000kg/mt	CC-100-60-06-NP-HDG	19,80€	CC-100-60-06-NP-PG	10,10€
150mm	60mm	3000mm	0,6mm	1,220kg/mt	CC-150-60-06-NP-HDG	23,85€	CC-150-60-06-NP-PG	11,95€
200mm	60mm	3000mm	0,6mm	1,440kg/mt	CC-200-60-06-NP-HDG	26,50€	CC-200-60-06-NP-PG	13,65€
300mm	60mm	3000mm	0,8mm	2,490kg/mt	CC-300-60-06-NP-HDG	36,15€	CC-300-60-06-NP-PG	17,75€
400mm	60mm	3000mm	0,9mm	3,450kg/mt	CC-400-60-09-NP-HDG	45,88€	CC-400-60-09-NP-PG	23,35€
500mm	60mm	3000mm	1,2mm	4,210kg/mt	CC-500-60-12-NP-HDG	58,75€	CC-500-60-12-NP-PG	39,95€
600mm	60mm	3000mm	1,2mm	4,860kg/mt	CC-600-60-12-NP-HDG	75,99€	CC-600-60-12-NP-PG	46,25€

- Artigo de stock habitual
- Artigo disponível por encomenda

Caminho Cabos Perfurado com Aba 40mm, com União Rápida Acabamento: Galvanizado a Quente - EN 1461

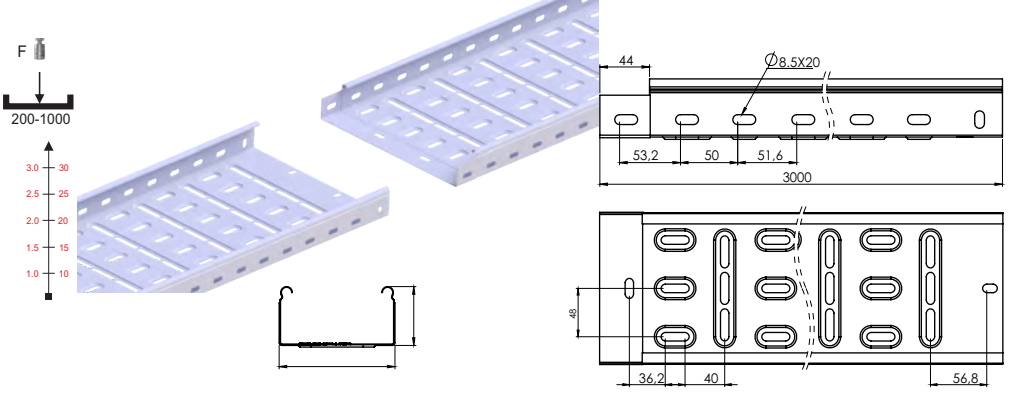
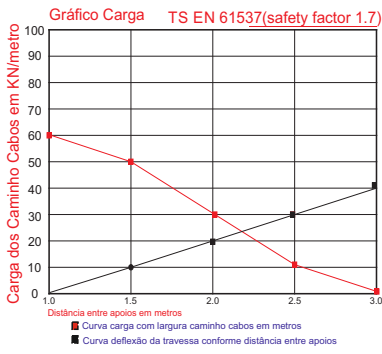

Código	mm	mm	mm	mm	kg/mt	Acabamento	P.U./mt €	
CC-050-40-06-HDG	50mm	40mm	3000mm	0,6mm	0,620kg/mt	Galvanizado a Quente	10,55€	●
CC-100-40-06-HDG	100mm	40mm	3000mm	0,6mm	0,857kg/mt	Galvanizado a Quente	12,15€	●
CC-150-40-06-HDG	150mm	40mm	3000mm	0,6mm	1,065kg/mt	Galvanizado a Quente	16,65€	●
CC-200-40-06-HDG	200mm	40mm	3000mm	0,6mm	1,280kg/mt	Galvanizado a Quente	19,50€	●
CC-300-40-08-HDG	300mm	40mm	3000mm	0,8mm	2,280kg/mt	Galvanizado a Quente	23,55€	●

- Artigo de stock habitual
- Artigo disponível por encomenda

Caminho Cabos Perdurado com Aba de 60mm Acabamento: Galvanizado a Quente - EN 1461

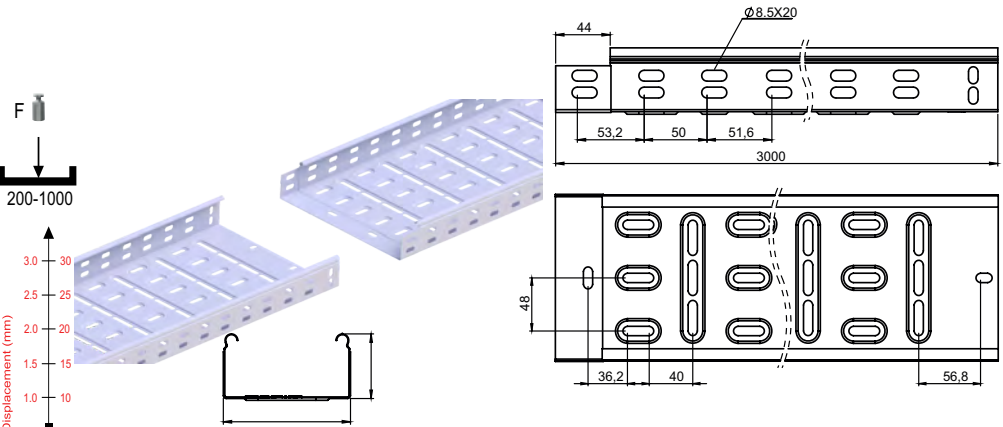
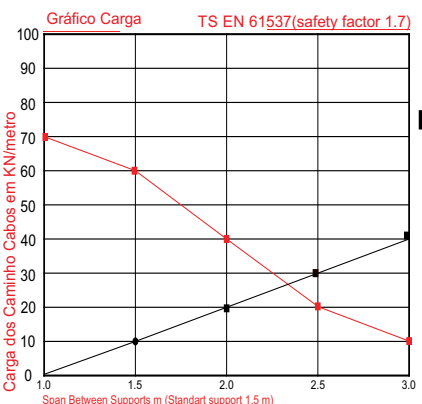

Código	mm	mm	mm	mm	kg/mt	Acabamento	P.U./mt €	
CC-050-50-07-HDG	50mm	50mm	3000mm	0,7mm	0,720kg/mt	Galvanizado a Quente	14,20€	●
CC-100-60-07-HDG	100mm	60mm	3000mm	0,7mm	1,170kg/mt	Galvanizado a Quente	14,65€	●
CC-150-60-07-HDG	150mm	60mm	3000mm	0,7mm	1,420kg/mt	Galvanizado a Quente	17,57€	●
CC-200-60-07-HDG	200mm	60mm	3000mm	0,7mm	1,680kg/mt	Galvanizado a Quente	20,90€	●
CC-300-60-09-HDG	300mm	60mm	3000mm	0,9mm	2,800kg/mt	Galvanizado a Quente	26,90€	●
CC-400-60-10-HDG	400mm	60mm	3000mm	1,0mm	3,840kg/mt	Galvanizado a Quente	38,82€	●
CC-500-60-12-HDG	500mm	60mm	3000mm	1,2mm	4,270kg/mt	Galvanizado a Quente	47,50€	●
CC-600-60-12-HDG	600mm	60mm	3000mm	1,2mm	4,960kg/mt	Galvanizado a Quente	60,40€	●

- Artigo de stock habitual
- Artigo disponível por encomenda

União Lateral para Caminho Cabos

Acabamento: Sendzimir - EN 10346

Acabamento: Galvanizado a Quente - EN 1461

União 40/50mm

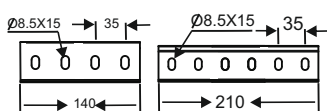

União 60mm

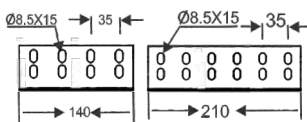

União 100mm

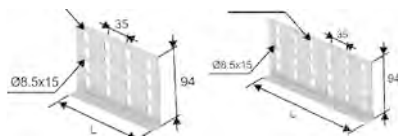
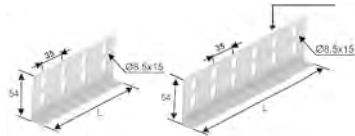
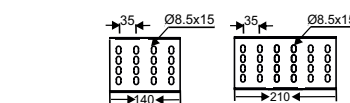

mm	mm	kg	mm	Código (Galvanizado Quente)	P.U. €		Código (Sendzimir)	P.U. €	
40mm	145mm	0,055kg	1,2mm	CC-U1-040L145-HDG	3,65€	●	CC-U1-040L145-PG	0,69€	●
50mm	145mm	0,070kg	1,2mm	CC-U1-050L145-HDG	4,25€	●	CC-U1-050L145-PG	1,45€	●
60mm	145mm	0,078kg	1,2mm	CC-U1-060L145-HDG	4,95€	●	CC-U1-060L145-PG	1,59€	●
60mm	210mm	0,120kg	1,2mm	CC-U1-060L210-HDG	5,25€	●	CC-U1-060L210-PG	1,80€	●
100mm	210mm	0,175kg	1,2mm	CC-U1-100L210-HDG	5,95€	●	CC-U1-100L210-PG	2,35€	●

- Artigo de stock habitual
- Artigo disponível por encomenda

Tampa para Caminho Cabos em Chapa e Varão

Acabamento: Sendzimir - EN 10346

Acabamento: Galvanizado a Quente - EN 1461

Tampa de Encaixe por pressão,
Não necessita de Clip fixação

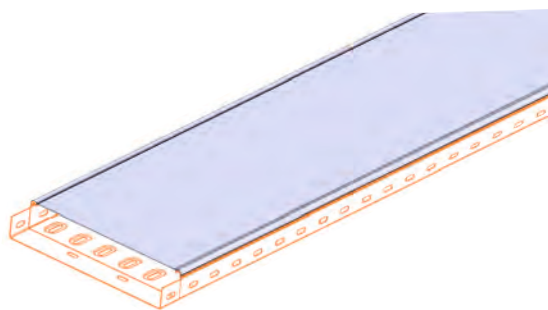
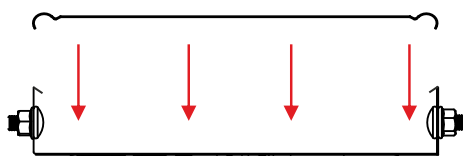

mm	mm	mm	kg/mt	Código(Galvanizado Quente)	P.U./mt €		Código(Sendzimir)	P.U./mt €	
50mm	0,6mm	3000mm	0,270kg/mt	CV-TP-050-07-HDG(p/Cam.Cabos de Varão)	4,42€	●	CV-TP-050-06-PG(p/Cam.Cabos Varão)	2,55€	●
50mm	0,6mm	3000mm	0,270kg/mt	CC-TP-050-07-HDG	4,42€	●	CC-TP-050-06-PG	2,55€	●
100mm	0,6mm	3000mm	0,470kg/mt	CC-TP-100-07-HDG	6,32€	●	CC-TP-100-06-PG	3,99€	●
150mm	0,6mm	3000mm	0,660kg/mt	CC-TP-150-07-HDG	8,50€	●	CC-TP-150-06-PG	5,45€	●
200mm	0,7mm	3000mm	1,030kg/mt	CC-TP-200-08-HDG	10,75€	●	CC-TP-200-07-PG	6,91€	●
300mm	0,8mm	3000mm	1.750kg/mt	CC-TP-300-08-HDG	19,50€	●	CC-TP-300-08-PG	12,68€	●
400mm	0,8mm	3000mm	2,300kg/mt	CC-TP-400-08-HDG	25,30€	●	CC-TP-400-08-PG	16,49€	●
500mm	1,0mm	3000mm	3,670kg/mt	CC-TP-500-10-HDG	38,50€	●	CC-TP-500-10-PG	25,11€	●
600mm	1,0mm	3000mm	4,380kg/mt	CC-TP-600-10-HDG	45,60€	●	CC-TP-600-10-PG	29,95€	●

- Artigo de stock habitual
- Artigo disponível por encomenda

Curva Ajustável 90° a 180° para Caminho Cabos

Acabamento: Sendzimir - EN 10346

Acabamento: Galvanizado a Quente - EN 1461

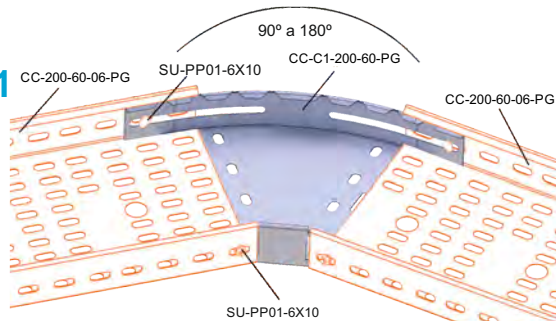
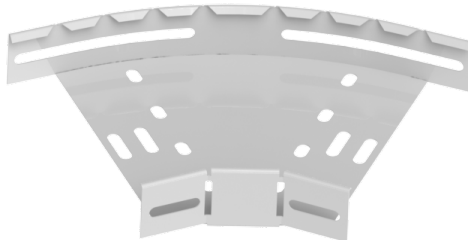
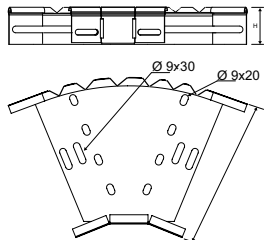

mm	mm	kg	mm	Código (Galvanizado Quente)	P.U. €	Código (Sendzimir)	P.U. €
50mm	40mm	0,180kg	1,2mm	CC-C1-050-40-HDG	28,00€	CC-C1-050-40-PG	20,70€
100mm	40mm	0,230kg	1,2mm	CC-C1-100-40-HDG	32,75€	CC-C1-100-40-PG	24,25€
150mm	40mm	0,300kg	1,2mm	CC-C1-150-40-HDG	34,65€	CC-C1-150-40-PG	25,65€
200mm	40mm	0,320kg	1,2mm	CC-C1-200-40-HDG	36,25€	CC-C1-200-40-PG	26,85€
300mm	40mm	0,390kg	1,2mm	CC-C1-300-40-HDG	56,85€	CC-C1-300-40-PG	42,15€
50mm	50mm	0,200kg	1,2mm	CC-C1-050-50-HDG	29,65€	CC-C1-050-50-PG	21,90€
100mm	60mm	0,280kg	1,2mm	CC-C1-100-60-HDG	32,80€	CC-C1-100-60-PG	24,25€
150mm	60mm	0,280kg	1,2mm	CC-C1-150-60-HDG	34,85€	CC-C1-150-60-PG	25,65€
200mm	60mm	0,330kg	1,2mm	CC-C1-200-60-HDG	36,35€	CC-C1-200-60-PG	26,85€
300mm	60mm	0,470kg	1,2mm	CC-C1-300-60-HDG	56,00€	CC-C1-300-60-PG	41,50€
400mm	60mm	0,540kg	1,2mm	CC-C1-400-60-HDG	112,55€	CC-C1-400-60-PG	83,35€
500mm	60mm	0,590kg	1,2mm	CC-C1-500-60-HDG	138,85€	CC-C1-500-60-PG	102,85€
600mm	60mm	0,620kg	1,2mm	CC-C1-600-60-HDG	163,30€	CC-C1-600-60-PG	120,90€

- Artigo de stock habitual
- Artigo disponível por encomenda

União Vertical Ajustável para Caminho Cabos

Acabamento: Sendzimir - EN 10346

Acabamento: Galvanizado a Quente - EN 1461

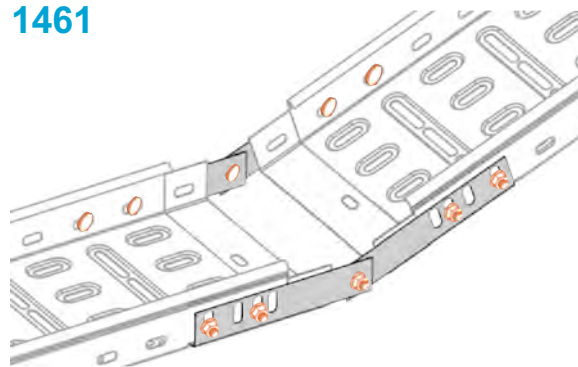
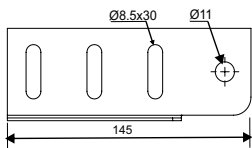

mm	mm	kg	mm	Código (Galvanizado Quente)	P.U. €	Código (Sendzimir)	P.U. €
40mm	160mm	0,055kg	1,2mm	CC-U2-040L160-HDG	8,85€	CC-U2-040L160-PG	4,35€
50mm	160mm	0,085kg	1,2mm	CC-U2-050L160-HDG	9,30€	CC-U2-050L160-PG	4,65€
60mm	160mm	0,100kg	1,2mm	CC-U2-060L160-HDG	9,60€	CC-U2-060L160-PG	4,85€
100mm	160mm	0,160kg	1,2mm	CC-U2-100L-160-HDG	18,85€	CC-U2-100L-160-PG	9,70€

- Artigo de stock habitual
- Artigo disponível por encomenda

União Horizontal Interior/Exterior para Caminho Cabos

Acabamento: Sendzimir - EN 10346

Acabamento: Galvanizado a Quente - EN 1461

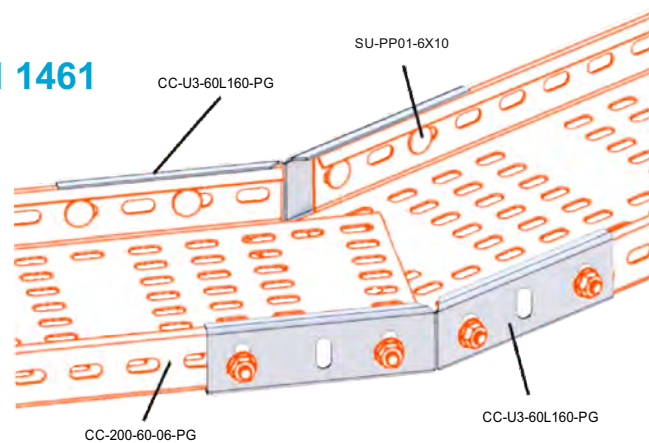
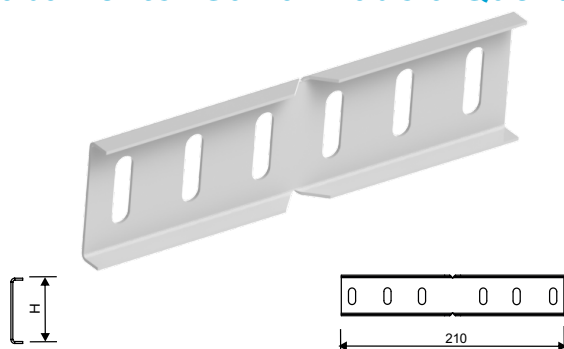

mm	mm	mm	kg	Código (Galvanizado Quente)	P.U. €	Código (Sendzimir)	P.U. €
40mm	210mm	1,2mm	0,190kg	CC-U3-040L210-HDG	7,70€	CC-U3-040L210-PG	4,45€
50mm	210mm	1,2mm	0,160kg	CC-U3-050L210-HDG	9,40€	CC-U3-050L210-PG	4,70€
60mm	210mm	1,2mm	0,255kg	CC-U3-060L210-HDG	10,00€	CC-U3-060L210-PG	5,20€
100mm	210mm	1,2mm	0,260kg	CC-U3-100L-210-HDG	13,40€	CC-U3-100L-210-PG	7,70€

- Artigo de stock habitual
- Artigo disponível por encomenda

Tê Vertical para Caminho Cabos

Acabamento: Sendzimir - EN 10346

Acabamento: Galvanizado a Quente - EN 1461

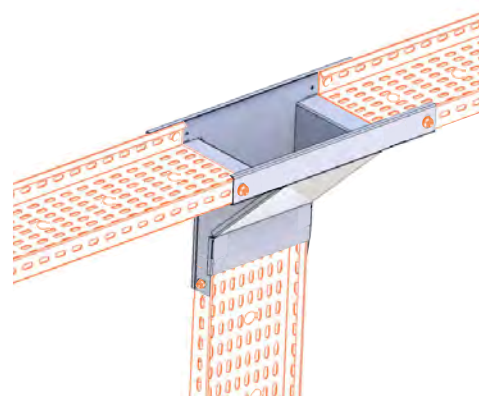
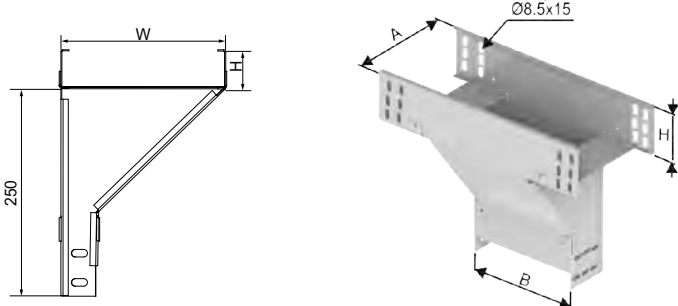

mm	mm	mm	kg	Código (Galvanizado Quente)	P.U. €	Código (Sendzimir)	P.U. €
50mm	40mm	1,2mm	1,150kg	CC-T1-050-40-HDG	52,20€	CC-T1-050-40-PG	38,65€
100mm	40mm	1,2mm	1,675kg	CC-T1-100-40-HDG	79,10€	CC-T1-100-40-PG	58,55€
150mm	40mm	1,2mm	2,195kg	CC-T1-150-40-HDG	110,60€	CC-T1-150-40-PG	81,90€
200mm	40mm	1,2mm	2,870kg	CC-T1-200-40-HDG	129,50€	CC-T1-200-40-PG	95,95€
300mm	40mm	1,2mm	4,285kg	CC-T1-300-40-HDG	192,60€	CC-T1-300-40-PG	142,69€
50mm	50mm	1,2mm	1,290kg	CC-T1-050-50-HDG	57,65€	CC-T1-050-50-PG	42,70€
100mm	60mm	1,2mm	1,985kg	CC-T1-100-60-HDG	88,50€	CC-T1-100-60-PG	65,55€
150mm	60mm	1,2mm	2,190kg	CC-T1-150-60-HDG	107,40€	CC-T1-150-60-PG	79,60€
200mm	60mm	1,2mm	3,220kg	CC-T1-200-60-HDG	145,40€	CC-T1-200-60-PG	107,65€
300mm	60mm	1,2mm	4,685kg	CC-T1-300-60-HDG	224,35€	CC-T1-300-60-PG	166,15€
400mm	60mm	1,2mm	8,500kg	CC-T1-400-60-HDG	353,80€	CC-T1-400-60-PG	262,00€
500mm	60mm	1,2mm	11,140kg	CC-T1-500-60-HDG	467,50€	CC-T1-500-60-PG	346,25€
600mm	60mm	1,2mm	13,980kg	CC-T1-600-60-HDG	590,35€	CC-T1-600-60-PG	437,25€

- Artigo de stock habitual
- Artigo disponível por encomenda

Curva Interior 90° para Caminho Cabos

Acabamento: Sendzimir - EN 10346

Acabamento: Galvanizado a Quente - EN 1461

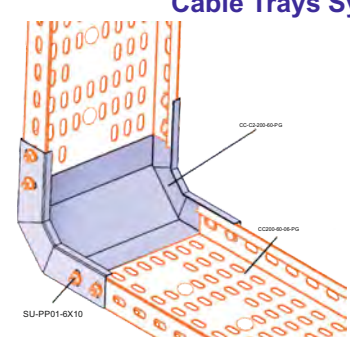
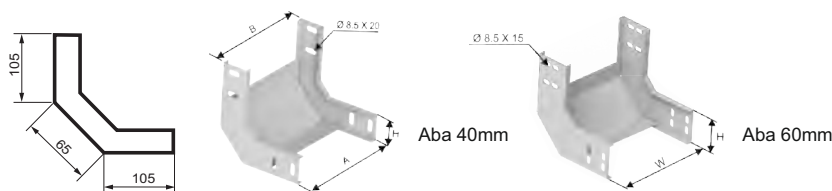

mm	mm	mm	kg	Código (Galvanizado Quente)	P.U. €		Código (Sendzimir)	P.U. €	
50mm	40mm	1,2mm	0,340kg	CC-C2-050-40-HDG	21,15€	●	CC-C2-050-40-PG	15,65€	●
100mm	40mm	1,2mm	0,410kg	CC-C2-100-40-HDG	24,10€	●	CC-C2-100-40-PG	17,85€	●
150mm	40mm	1,2mm	0,475kg	CC-C2-150-40-HDG	29,50€	●	CC-C2-150-40-PG	21,85€	●
200mm	40mm	1,2mm	0,550kg	CC-C2-200-40-HDG	35,35€	●	CC-C2-200-40-PG	26,15€	●
300mm	40mm	1,2mm	0,685kg	CC-C2-300-40-HDG	26,90€	●	CC-C2-300-40-PG	36,25€	●
50mm	50mm	1,2mm	0,405kg	CC-C2-050-50-HDG	23,90€	●	CC-C2-050-50-PG	17,70€	●
100mm	60mm	1,2mm	0,555kg	CC-C2-100-60-HDG	24,80€	●	CC-C2-100-60-PG	18,35€	●
150mm	60mm	1,2mm	0,640kg	CC-C2-150-60-HDG	29,50€	●	CC-C2-150-60-PG	21,85€	●
200mm	60mm	1,2mm	0,725kg	CC-C2-200-60-HDG	32,55€	●	CC-C2-200-60-PG	24,10€	●
300mm	60mm	1,2mm	0,895kg	CC-C2-300-60-HDG	49,10€	●	CC-C2-300-60-PG	36,35€	●
400mm	60mm	1,2mm	1,070kg	CC-C2-400-60-HDG	64,95€	●	CC-C2-400-60-PG	48,10€	●
500mm	60mm	1,2mm	1,240kg	CC-C2-500-60-HDG	71,45€	●	CC-C2-500-60-PG	52,90€	●
600mm	60mm	1,2mm	1,410kg	CC-C2-600-60-HDG	93,70€	●	CC-C2-600-60-PG	69,40€	●
100mm	100mm	1,2mm	0,920kg	CC-C2-100-100-HDG	35,50€	●	CC-C2-100-100-PG	24,85€	●
200mm	100mm	1,2mm	1,050kg	CC-C2-200-100-HDG	43,55€	●	CC-C2-200-100-PG	30,10€	●
300mm	100mm	1,2mm	1,175kg	CC-C2-300-100-HDG	55,10€	●	CC-C2-300-100-PG	38,35€	●
400mm	100mm	1,2mm	1,250kg	CC-C2-400-100-HDG	74,95€	●	CC-C2-400-100-PG	52,10€	●
500mm	100mm	1,2mm	1,375kg	CC-C2-500-100-HDG	83,45€	●	CC-C2-500-100-PG	57,90€	●
600mm	100mm	1,2mm	1,530kg	CC-C2-600-100-HDG	107,70€	●	CC-C2-600-100-PG	74,40€	●

- Artigo de stock habitual
- Artigo disponível por encomenda

Tampa para Curva Interior 90° para Caminho Cabos

Acabamento: Sendzimir - EN 10346

Acabamento: Galvanizado a Quente - EN 1461

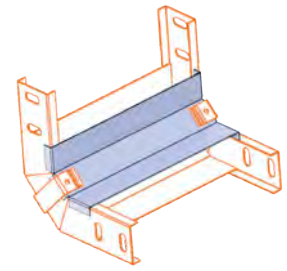
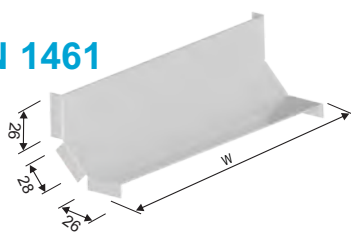
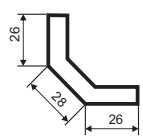

mm	mm	kg	Código (Galvanizado Quente)	P.U. €		Código (Sendzimir)	P.U. €	
50mm	1,2mm	0,340kg	CC-TP-C2-050-40-HDG	9,40€	●	CC-TP-C2-050-40-PG	6,95€	●
100mm	1,2mm	0,410kg	CC-TP-C2-100-40-HDG	11,00€	●	CC-TP-C2-100-40-PG	8,10€	●
150mm	1,2mm	0,475kg	CC-TP-C2-150-40-HDG	14,45€	●	CC-TP-C2-150-40-PG	10,70€	●
200mm	1,2mm	0,550kg	CC-TP-C2-200-40-HDG	25,45€	●	CC-TP-C2-200-40-PG	11,85€	●
300mm	1,2mm	0,685kg	CC-TP-C2-300-40-HDG	24,80€	●	CC-TP-C2-300-40-PG	18,35€	●
400mm	1,2mm	1,070kg	CC-TP-C2-400-60-HDG	32,55€	●	CC-TP-C2-400-60-PG	24,10€	●
500mm	1,2mm	1,240kg	CC-TP-C2-500-60-HDG	36,10€	●	CC-TP-C2-500-60-PG	26,70€	●
600mm	1,2mm	1,410kg	CC-TP-C2-600-60-HDG	37,80€	●	CC-TP-C2-600-60-PG	28,00€	●

- Artigo de stock habitual
- Artigo disponível por encomenda

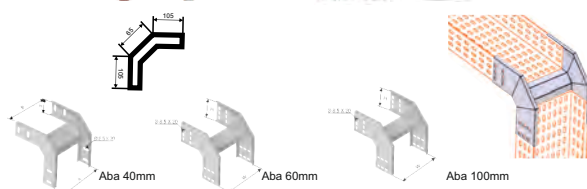

Curva Exterior 90° para Caminho Cabos

Acabamento: Sendzimir - EN 10346
Acabamento: Galvanizado a Quente - EN 1461

mm	mm	mm	kg	Código (Galvanizado Quente)	P.U. €		Código (Sendzimir)	P.U. €	
50mm	40mm	1,2mm	0,310kg	CC-C3-050-40-HDG	21,15€	●	CC-C3-050-40-PG	15,65€	●
100mm	40mm	1,2mm	0,345kg	CC-C3-100-40-HDG	24,80€	●	CC-C3-100-40-PG	18,35€	●
150mm	40mm	1,2mm	0,380kg	CC-C3-150-40-HDG	29,50€	●	CC-C3-150-40-PG	21,85€	●
200mm	40mm	1,2mm	0,420kg	CC-C3-200-40-HDG	35,30€	●	CC-C3-200-40-PG	26,15€	●
300mm	40mm	1,2mm	0,500kg	CC-C3-300-40-HDG	48,95€	●	CC-C3-300-40-PG	36,25€	●
50mm	50mm	1,2mm	0,310kg	CC-C3-050-50-HDG	22,55€	●	CC-C3-050-50-PG	16,70€	●
100mm	60mm	1,2mm	0,460kg	CC-C3-100-60-HDG	24,80€	●	CC-C3-100-60-PG	18,35€	●
150mm	60mm	1,2mm	0,490kg	CC-C3-150-60-HDG	29,50€	●	CC-C3-150-60-PG	21,85€	●
200mm	60mm	1,2mm	0,535kg	CC-C3-200-60-HDG	32,55€	●	CC-C3-200-60-PG	24,10€	●
300mm	60mm	1,2mm	0,610kg	CC-C3-300-60-HDG	49,10€	●	CC-C3-300-60-PG	36,35€	●
400mm	60mm	1,2mm	0,685kg	CC-C3-400-60-HDG	65,00€	●	CC-C3-400-60-PG	48,10€	●
500mm	60mm	1,2mm	0,760kg	CC-C3-500-60-HDG	71,45€	●	CC-C3-500-60-PG	52,90€	●
600mm	60mm	1,2mm	0,835kg	CC-C3-600-60-HDG	93,70€	●	CC-C3-600-60-PG	69,40€	●
100mm	100mm	1,2mm	0,590kg	CC-C3-100-100-HDG	34,50€	●	CC-C3-100-100-PG	23,85€	●
200mm	100mm	1,2mm	0,635kg	CC-C3-200-100-HDG	37,55€	●	CC-C3-200-100-PG	26,10€	●
300mm	100mm	1,2mm	0,710kg	CC-C3-300-100-HDG	56,10€	●	CC-C3-300-100-PG	39,35€	●
400mm	100mm	1,2mm	0,885kg	CC-C3-400-100-HDG	76,00€	●	CC-C3-400-100-PG	53,10€	●
500mm	100mm	1,2mm	0,960kg	CC-C3-500-100-HDG	81,45€	●	CC-C3-500-100-PG	56,90€	●
600mm	100mm	1,2mm	1,035kg	CC-C3-600-100-HDG	110,70€	●	CC-C3-600-100-PG	76,40€	●

- Artigo de stock habitual
- Artigo disponível por encomenda

Tampa p/Curva Exterior 90° para Caminho Cabos

Acabamento: Sendzimir - EN 10346
Acabamento: Galvanizado a Quente - EN 1461

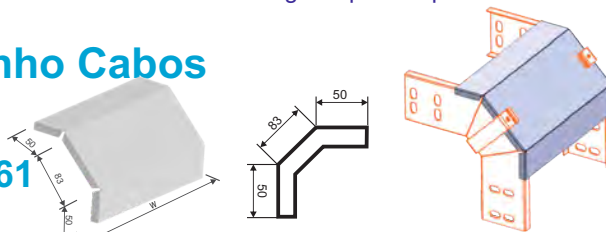

mm	mm	mm	kg	Código (Galvanizado Quente)	P.U. €		Código (Sendzimir)	P.U. €	
50mm	40mm	1,2mm	0,100kg	CC-TP-C3-050-40-HDG	9,40€	●	CC-TP-C3-050-40-PG	6,95€	●
100mm	40mm	1,2mm	0,170kg	CC-TP-C3-100-40-HDG	10,95€	●	CC-TP-C3-100-40-PG	8,10€	●
150mm	40mm	1,2mm	0,260kg	CC-TP-C3-150-40-HDG	14,45€	●	CC-TP-C3-150-40-PG	10,70€	●
200mm	40mm	1,2mm	0,310kg	CC-TP-C3-200-40-HDG	16,00€	●	CC-TP-C3-200-40-PG	11,85€	●
300mm	40mm	1,2mm	0,450kg	CC-TP-C3-300-40-HDG	24,80€	●	CC-TP-C3-300-40-PG	18,35€	●
50mm	50mm	1,2mm	0,110kg	CC-TP-C3-050-50-HDG	9,45€	●	CC-TP-C3-050-50-PG	7,00€	●
100mm	60mm	1,2mm	0,210kg	CC-TP-C3-100-60-HDG	10,95€	●	CC-TP-C3-100-60-PG	8,10€	●
150mm	60mm	1,2mm	0,310kg	CC-TP-C3-150-60-HDG	14,45€	●	CC-TP-C3-150-60-PG	10,70€	●
200mm	60mm	1,2mm	0,380kg	CC-TP-C3-200-60-HDG	16,00€	●	CC-TP-C3-200-60-PG	11,85€	●
300mm	60mm	1,2mm	0,550kg	CC-TP-C3-300-60-HDG	24,80€	●	CC-TP-C3-300-60-PG	18,35€	●
400mm	60mm	1,2mm	0,730kg	CC-TP-C3-400-60-HDG	32,55€	●	CC-TP-C3-400-60-PG	24,10€	●
500mm	60mm	1,2mm	0,900kg	CC-TP-C3-500-60-HDG	36,10€	●	CC-TP-C3-500-60-PG	26,70€	●
600mm	60mm	1,2mm	1,070kg	CC-TP-C3-600-60-HDG	32,75€	●	CC-TP-C3-600-60-PG	27,95€	●

- Artigo de stock habitual
- Artigo disponível por encomenda

Curva Interior / Exterior Ajustável P/Caminho Cabos

Acabamento: Sendzimir - EN 10346

Acabamento: Galvanizado a Quente - EN 1461

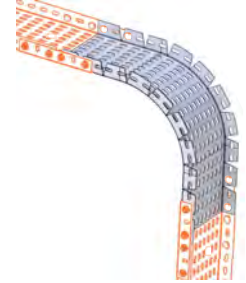
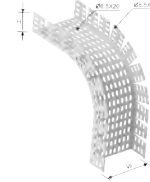
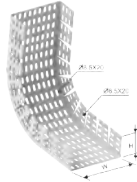
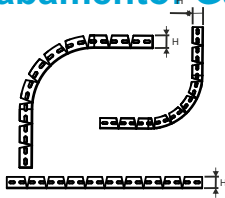

mm	mm	mm	kg	Código (Galvanizado Quente)	P.U. €		Código (Sendzimir)	P.U. €	
50mm	40mm	1,2mm	0,310kg	CC-C4-050-40-HDG	37,10€	●	CC-C4-050-40-PG	27,45€	●
100mm	40mm	1,2mm	0,345kg	CC-C4-100-40-HDG	49,55€	●	CC-C4-100-40-PG	36,70€	●
150mm	40mm	1,2mm	0,380kg	CC-C4-150-40-HDG	64,35€	●	CC-C4-150-40-PG	47,65€	●
200mm	40mm	1,2mm	0,420kg	CC-C4-200-40-HDG	74,40€	●	CC-C4-200-40-PG	55,10€	●
300mm	40mm	1,2mm	0,500kg	CC-C4-300-40-HDG	99,00€	●	CC-C4-300-40-PG	73,30€	●
50mm	50mm	1,2mm	0,310kg	CC-C4-050-50-HDG	52,65€	●	CC-C4-050-50-PG	39,00€	●
100mm	60mm	1,2mm	0,460kg	CC-C4-100-60-HDG	59,40€	●	CC-C4-100-60-PG	44,00€	●
150mm	60mm	1,2mm	0,490kg	CC-C4-150-60-HDG	74,40€	●	CC-C4-150-60-PG	55,10€	●
200mm	60mm	1,2mm	0,535kg	CC-C4-200-60-HDG	84,20€	●	CC-C4-200-60-PG	62,35€	●
300mm	60mm	1,2mm	0,610kg	CC-C4-300-60-HDG	108,90€	●	CC-C4-300-60-PG	80,60€	●
400mm	60mm	1,2mm	0,685kg	CC-C4-400-60-HDG	166,30€	●	CC-C4-400-60-PG	123,15€	●
500mm	60mm	1,2mm	0,760kg	CC-C4-500-60-HDG	197,95€	●	CC-C4-500-60-PG	146,60€	●
600mm	60mm	1,2mm	0,835kg	CC-C4-600-60-HDG	225,65€	●	CC-C4-600-60-PG	167,15€	●
100mm	100mm	1,2mm	0,520kg	CC-C4-100-100-HDG	67,40€	●	CC-C4-100-100-PG	47,10€	●
200mm	100mm	1,2mm	0,595kg	CC-C4-200-100-HDG	94,20€	●	CC-C4-200-100-PG	66,35€	●
300mm	100mm	1,2mm	0,680kg	CC-C4-300-100-HDG	120,90€	●	CC-C4-300-100-PG	84,60€	●
400mm	100mm	1,2mm	0,705kg	CC-C4-400-100-HDG	184,30€	●	CC-C4-400-100-PG	129,15€	●
500mm	100mm	1,2mm	0,780kg	CC-C4-500-100-HDG	219,95€	●	CC-C4-500-100-PG	153,60€	●
600mm	100mm	1,2mm	0,895kg	CC-C4-600-100-HDG	250,65€	●	CC-C4-600-100-PG	175,15€	●

Tampa P/ Curva Int./ Exterior P/ Caminho Cabos

Acabamento: Sendzimir - EN 10346

Acabamento: Galvanizado a Quente - EN 1461

- Artigo de stock habitual
- Artigo disponível por encomenda

CC-TP-C4-200-PG

CC-TP-C4-200-PG



CC-TP-C4-200-PG

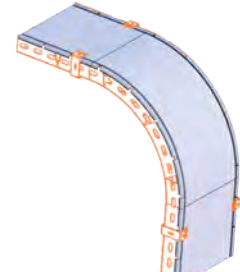
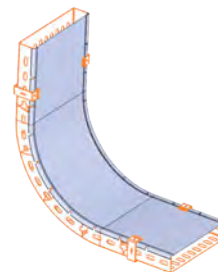

mm	mm	kg	Código (Galvanizado Quente)	P.U. €		Código (Sendzimir)	P.U. €	
50mm	1,0mm	0,570kg	CC-TP-C4-050-HDG	18,65€	●	CC-TP-C4-050-PG	13,80€	●
100mm	1,0mm	0,970kg	CC-TP-C4-100-HDG	31,00€	●	CC-TP-C4-100-PG	22,95€	●
150mm	1,0mm	1,460kg	CC-TP-C4-150-HDG	45,80€	●	CC-TP-C4-150-PG	33,90€	●
200mm	1,0mm	1,780kg	CC-TP-C4-200-HDG	55,65€	●	CC-TP-C4-200-PG	41,20€	●
300mm	1,0mm	2,590kg	CC-TP-C4-300-HDG	80,40€	●	CC-TP-C4-300-PG	59,55€	●
400mm	1,0mm	4,520kg	CC-TP-C4-400-HDG	131,45€	●	CC-TP-C4-400-PG	97,35€	●
500mm	1,0mm	5,600kg	CC-TP-C4-500-HDG	162,40€	●	CC-TP-C4-500-PG	120,25€	●
600mm	1,0mm	6,670kg	CC-TP-C4-600-HDG	193,20€	●	CC-TP-C4-600-PG	143,10€	●

- Artigo de stock habitual
- Artigo disponível por encomenda

Curva Angular Lateral para Caminho Cabos

Acabamento: Sendzimir - EN 10346

Acabamento: Galvanizado a Quente - EN 1461

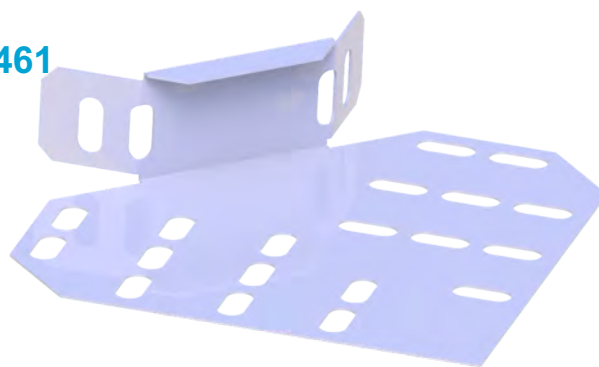

mm	mm	kg	Código (Galvanizado Quente)	P.U. €		Código (Sendzimir)	P.U. €	
40mm	1,2mm	0,200kg	CC-C6-040-HDG	13,10€	●	CC-C6-040-PG	9,70€	●
50mm	1,2mm	0,250kg	CC-C6-050-HDG	13,65€	●	CC-C6-050-PG	10,10€	●
60mm	1,2mm	0,300kg	CC-C6-060-HDG	14,25€	●	CC-C6-060-PG	10,55€	●

- Artigo de stock habitual
- Artigo disponível por encomenda

Derivação Angular Lateral para Caminho Cabos

Acabamento: Sendzimir - EN 10346

Acabamento: Galvanizado a Quente - EN 1461

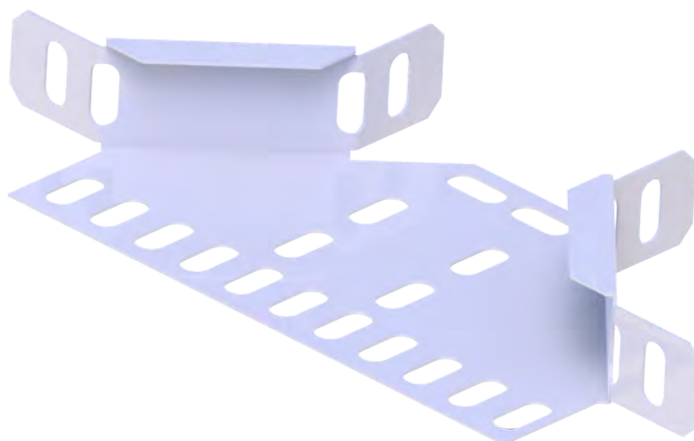

mm	mm	mm	kg	Código (Galvanizado Quente)	P.U. €		Código (Sendzimir)	P.U. €	
50mm	40mm	1,2mm	0,145kg	CC-T3-050-40-HDG	27,25€	●	CC-T3-050-40-PG	20,15€	●
100mm	40mm	1,2mm	0,205kg	CC-T3-100-40-HDG	29,70€	●	CC-T3-100-40-PG	22,00€	●
150mm	40mm	1,2mm	0,230kg	CC-T3-150-40-HDG	31,60€	●	CC-T3-150-40-PG	23,40€	●
200mm	40mm	1,2mm	0,255kg	CC-T3-200-40-HDG	34,80€	●	CC-T3-200-40-PG	25,75€	●
300mm	40mm	1,2mm	0,320kg	CC-T3-300-40-HDG	51,45€	●	CC-T3-300-40-PG	38,10€	●
50mm	50mm	1,2mm	0,170kg	CC-T3-050-50-HDG	30,25€	●	CC-T3-050-50-PG	22,40€	●
100mm	60mm	1,2mm	0,190kg	CC-T3-100-60-HDG	31,60€	●	CC-T3-100-60-PG	23,40€	●
150mm	60mm	1,2mm	0,260kg	CC-T3-150-60-HDG	32,95€	●	CC-T3-150-60-PG	24,40€	●
200mm	60mm	1,2mm	0,260kg	CC-T3-200-60-HDG	34,80€	●	CC-T3-200-60-PG	25,75€	●
300mm	60mm	1,2mm	0,330kg	CC-T3-300-60-HDG	51,50€	●	CC-T3-300-60-PG	38,15€	●
400mm	60mm	1,2mm	0,450kg	CC-T3-400-60-HDG	74,20€	●	CC-T3-400-60-PG	54,95€	●
500mm	60mm	1,2mm	0,550kg	CC-T3-500-60-HDG	84,00€	●	CC-T3-500-60-PG	62,20€	●
600mm	60mm	1,2mm	0,600kg	CC-T3-600-60-HDG	89,85€	●	CC-T3-600-60-PG	66,55€	●

- Artigo de stock habitual
- Artigo disponível por encomenda

Curva Plana para Caminho Cabos

Acabamento: Sendzimir - EN 10346

Acabamento: Galvanizado a Quente - EN 1461

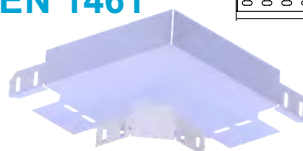
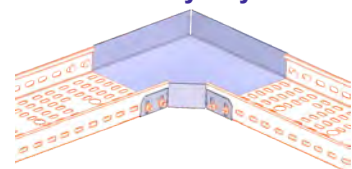
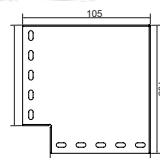

mm ↔	mm ↑	mm ↔	kg	Código (Galvanizado Quente)	P.U. €		Código (Sendzimir)	P.U. €	
50mm	40mm	1,2mm	0,141kg	CC-C5-050-40-HDG	27,75€	●	CC-C5-050-40-PG	20,55€	●
100mm	40mm	1,2mm	0,251kg	CC-C5-100-40-HDG	30,35€	●	CC-C5-100-40-PG	22,45€	●
150mm	40mm	1,2mm	0,393kg	CC-C5-150-40-HDG	32,30€	●	CC-C5-150-40-PG	23,90€	●
200mm	40mm	1,2mm	0,565Kg	CC-C5-200-40-HDG	34,65€	●	CC-C5-200-40-PG	25,65€	●
300mm	40mm	1,2mm	1,0005kg	CC-C5-300-40-HDG	49,10€	●	CC-C5-300-40-PG	36,35€	●
50mm	50mm	1,2mm	0,161kg	CC-C5-050-50-HDG	27,80€	●	CC-C5-050-50-PG	20,60€	●
100mm	60mm	1,2mm	0,332kg	CC-C5-100-60-HDG	30,40€	●	CC-C5-100-60-PG	22,60€	●
150mm	60mm	1,2mm	0,492kg	CC-C5-150-60-HDG	32,40€	●	CC-C5-150-60-PG	23,95€	●
200mm	60mm	1,2mm	0,684kg	CC-C5-200-60-HDG	34,70€	●	CC-C5-200-60-PG	25,70€	●
300mm	60mm	1,2mm	1,161Kg	CC-C5-300-60-HDG	49,15€	●	CC-C5-300-60-PG	36,50€	●
400mm	60mm	1,2mm	2,205kg	CC-C5-400-60-HDG	56,10€	●	CC-C5-400-60-PG	41,55€	●
500mm	60mm	1,2mm	3,116Kg	CC-C5-500-60-HDG	64,70€	●	CC-C5-500-60-PG	47,90€	●
600mm	60mm	1,2mm	5,020Kg	CC-C5-600-60-HDG	84,65€	●	CC-C5-600-60-PG	62,70€	●
100mm	100mm	1,2mm	0,492kg	CC-C5-100-100-HDG	41,40€	●	CC-C5-100-100-PG	29,95€	●
200mm	100mm	1,2mm	0,784kg	CC-C5-200-100-HDG	44,70€	●	CC-C5-200-100-PG	29,70€	●
300mm	100mm	1,2mm	1,221Kg	CC-C5-300-100-HDG	56,15€	●	CC-C5-300-100-PG	39,50€	●
400mm	100mm	1,2mm	2,405kg	CC-C5-400-100-HDG	66,10€	●	CC-C5-400-100-PG	46,55€	●
500mm	100mm	1,2mm	3,316Kg	CC-C5-500-100-HDG	78,70€	●	CC-C5-500-100-PG	54,90€	●
600mm	100mm	1,2mm	5,320Kg	CC-C5-600-100-HDG	99,65€	●	CC-C5-600-100-PG	69,70€	●

- Artigo de stock habitual
- Artigo disponível por encomenda

Tampa P/ Curva Plana P/ Caminho Cabos

Acabamento: Sendzimir - EN 10346

Acabamento: Galvanizado a Quente - EN 1461

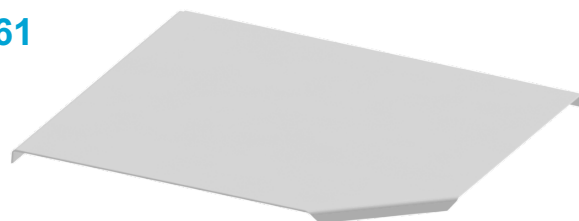
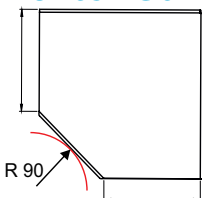

mm ↔	mm ↔	kg	Código (Galvanizado Quente)	P.U. €		Código (Sendzimir)	P.U. €	
50mm	1,0mm	0,120kg	CC-TP-C5-050-HDG	9,45€	●	CC-TP-C5-050-PG	7,00€	●
100mm	1,0mm	0,250kg	CC-TP-C5-100-HDG	10,95€	●	CC-TP-C5-100-PG	8,10€	●
150mm	1,0mm	0,460kg	CC-TP-C5-150-HDG	14,45€	●	CC-TP-C5-150-PG	10,70€	●
200mm	1,0mm	0,640kg	CC-TP-C5-200-HDG	16,00€	●	CC-TP-C5-200-PG	11,80€	●
300mm	1,0mm	1,200kg	CC-TP-C5-300-HDG	24,85€	●	CC-TP-C5-300-PG	18,40€	●
400mm	1,0mm	2,440kg	CC-TP-C5-400-HDG	32,60€	●	CC-TP-C5-400-PG	24,10€	●
500mm	1,0mm	3,610kg	CC-TP-C5-500-HDG	36,10€	●	CC-TP-C5-500-PG	26,70€	●
600mm	1,0mm	4,960kg	CC-TP-C5-600-HDG	45,85€	●	CC-TP-C5-600-PG	31,00€	●

- Artigo de stock habitual
- Artigo disponível por encomenda

Tê Plano para Caminho Cabos
Acabamento: Sendzimir - EN 10346
Acabamento: Galvanizado a Quente - EN 1461

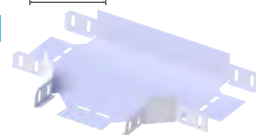
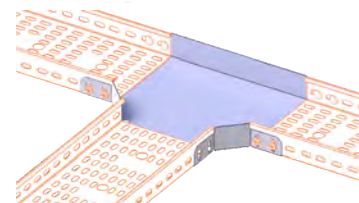
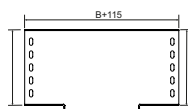

mm K	mm H	mm K	kg	Código (Galvanizado Quente)	P.U. €		Código (Sendzimir)	P.U. €	
50mm	40mm	1,2mm	0,160kg	CC-T2-050-40-HDG	38,75€	●	CC-T2-050-40-PG	28,70€	●
100mm	40mm	1,2mm	0,276kg	CC-T2-100-40-HDG	42,00€	●	CC-T2-100-40-PG	31,10€	●
150mm	40mm	1,2mm	0,424kg	CC-T2-150-40-HDG	46,65€	●	CC-T2-150-40-PG	34,55€	●
200mm	40mm	1,2mm	0,603Kg	CC-T2-200-40-HDG	51,10€	●	CC-T2-200-40-PG	37,80€	●
300mm	40mm	1,2mm	1,055kg	CC-T2-300-40-HDG	70,40€	●	CC-T2-300-40-PG	52,15€	●
50mm	50mm	1,2mm	0,171kg	CC-T2-050-50-HDG	41,10€	●	CC-T2-050-50-PG	30,40€	●
100mm	60mm	1,2mm	0,361kg	CC-T2-100-60-HDG	42,00€	●	CC-T2-100-60-PG	31,10€	●
150mm	60mm	1,2mm	0,528kg	CC-T2-150-60-HDG	46,65€	●	CC-T2-150-60-PG	34,55€	●
200mm	60mm	1,2mm	0,725kg	CC-T2-200-60-HDG	51,10	●	CC-T2-200-60-PG	37,80€	●
300mm	60mm	1,2mm	1,215Kg	CC-T2-300-60-HDG	67,30€	●	CC-T2-300-60-PG	49,85€	●
400mm	60mm	1,2mm	2,288kg	CC-T2-400-60-HDG	92,65€	●	CC-T2-400-60-PG	68,60€	●
500mm	60mm	1,2mm	3,215Kg	CC-T2-500-60-HDG	94,95€	●	CC-T2-500-60-PG	70,30€	●
600mm	60mm	1,2mm	5,157Kg	CC-T2-600-60-HDG	116,10€	●	CC-T2-600-60-PG	86,00€	●
100mm	100mm	1,2mm	0,528kg	CC-T2-100-100-HDG	54,65€	●	CC-T2-100-100-PG	37,55€	●
200mm	100mm	1,2mm	0,785kg	CC-T2-200-100-HDG	58,10	●	CC-T2-200-100-PG	40,80€	●
300mm	100mm	1,2mm	1,315Kg	CC-T2-300-100-HDG	80,30€	●	CC-T2-300-100-PG	55,85€	●
400mm	100mm	1,2mm	2,488kg	CC-T2-400-100-HDG	105,65€	●	CC-T2-400-100-PG	73,60€	●
500mm	100mm	1,2mm	3,355Kg	CC-T2-500-100-HDG	111,95€	●	CC-T2-500-100-PG	78,30€	●
600mm	100mm	1,2mm	5,287Kg	CC-T2-600-100-HDG	133,10€	●	CC-T2-600-100-PG	93,00€	●

Tampa P/ Tê Plano para Caminho Cabos
Acabamento: Sendzimir - EN 10346
Acabamento: Galvanizado a Quente - EN 1461

- Artigo de stock habitual
- Artigo disponível por encomenda

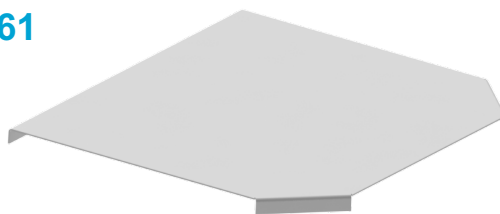
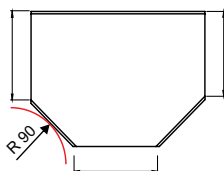

mm K	mm K	kg	Código (Galvanizado Quente)	P.U. €		Código (Sendzimir)	P.U. €	
50mm	1,0mm	0,140kg	CC-TP-T2-050-HDG	7,30€	●	CC-TP-T2-050-PG	5,40€	●
100mm	1,0mm	0,290kg	CC-TP-T2-100-HDG	8,35€	●	CC-TP-T2-100-PG	6,15€	●
150mm	1,0mm	0,530kg	CC-TP-T2-150-HDG	11,45€	●	CC-TP-T2-150-PG	8,45€	●
200mm	1,0mm	0,780kg	CC-TP-T2-200-HDG	12,80€	●	CC-TP-T2-200-PG	9,45€	●
300mm	1,0mm	1,360kg	CC-TP-T2-300-HDG	16,50€	●	CC-TP-T2-300-PG	12,20€	●
400mm	1,0mm	2,720kg	CC-TP-T2-400-HDG	22,85€	●	CC-TP-T2-400-PG	16,90€	●
500mm	1,0mm	3,980kg	CC-TP-T2-500-HDG	25,60€	●	CC-TP-T2-500-PG	18,95€	●
600mm	1,0mm	5,470kg	CC-TP-T2-600-HDG	31,95€	●	CC-TP-T2-600-PG	23,65€	●

- Artigo de stock habitual
- Artigo disponível por encomenda

Cruzamento Plano para Caminho Cabos

Acabamento: Sendzimir - EN 10346
Acabamento: Galvanizado a Quente - EN 1461

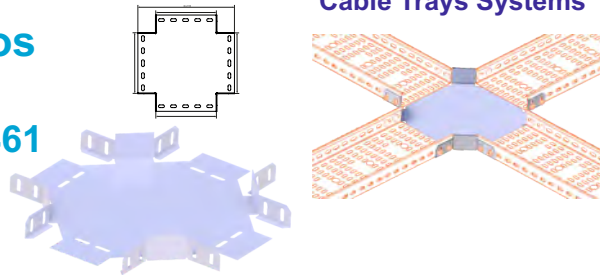

mm ↔	mm ↑	mm ↔	kg	Código (Galvanizado Quente)	P.U. €		Código (Sendzimir)	P.U. €	
50mm	40mm	1,2mm	0,180kg	CC-X1-050-40-HDG	57,40€	●	CC-X1-050-40-PG	42,50€	●
100mm	40mm	1,2mm	0,304kg	CC-X1-100-40-HDG	61,90€	●	CC-X1-100-40-PG	45,80€	●
150mm	40mm	1,2mm	0,458kg	CC-X1-150-40-HDG	63,95€	●	CC-X1-150-40-PG	47,35€	●
200mm	40mm	1,2mm	0,643Kg	CC-X1-200-40-HDG	66,30€	●	CC-X1-200-40-PG	49,10€	●
300mm	40mm	1,2mm	1,108kg	CC-X1-300-40-HDG	80,90€	●	CC-X1-300-40-PG	59,90€	●
50mm	50mm	1,2mm	0,192g	CC-X1-050-50-HDG	60,70€	●	CC-X1-050-50-PG	44,95€	●
100mm	60mm	1,2mm	0,393kg	CC-X1-100-60-HDG	61,90€	●	CC-X1-100-60-PG	45,80€	●
150mm	60mm	1,2mm	0,565kg	CC-X1-150-60-HDG	63,95€	●	CC-X1-150-60-PG	47,35€	●
200mm	60mm	1,2mm	0,769kg	CC-X1-200-60-HDG	66,30€	●	CC-X1-200-60-PG	49,10€	●
300mm	60mm	1,2mm	1,272Kg	CC-X1-300-60-HDG	80,90€	●	CC-X1-300-60-PG	59,90€	●
400mm	60mm	1,2mm	2,375kg	CC-X1-400-60-HDG	120,70€	●	CC-X1-400-60-PG	89,40€	●
500mm	60mm	1,2mm	3,317Kg	CC-X1-500-60-HDG	129,35€	●	CC-X1-500-60-PG	95,80€	●
600mm	60mm	1,2mm	5,299Kg	CC-X1-600-60-HDG	158,10€	●	CC-X1-600-60-PG	117,10€	●
100mm	100mm	1,2mm	0,585kg	CC-X1-100-100-HDG	70,95€	●	CC-X1-100-100-PG	49,35€	●
200mm	100mm	1,2mm	0,819kg	CC-X1-200-100-HDG	75,30€	●	CC-X1-200-100-PG	53,10€	●
300mm	100mm	1,2mm	1,372Kg	CC-X1-300-100-HDG	89,90€	●	CC-X1-300-100-PG	64,90€	●
400mm	100mm	1,2mm	2,485kg	CC-X1-400-100-HDG	130,70€	●	CC-X1-400-100-PG	94,40€	●
500mm	100mm	1,2mm	3,437Kg	CC-X1-500-100-HDG	141,35€	●	CC-X1-500-100-PG	99,80€	●
600mm	100mm	1,2mm	5,505Kg	CC-X1-600-100-HDG	173,10€	●	CC-X1-600-100-PG	123,10€	●

● Artigo de stock habitual

● Artigo disponível por encomenda

Tampa P/ Cruzamento Plano para Caminho Cabos

Acabamento: Sendzimir - EN 10346
Acabamento: Galvanizado a Quente - EN 1461

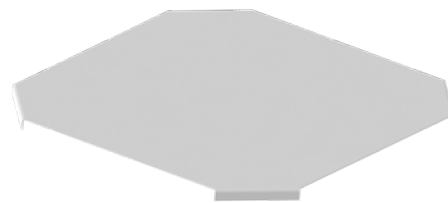
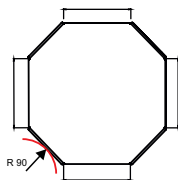

mm ↔	mm ↔	kg	Código (Galvanizado Quente)	P.U. €		Código (Sendzimir)	P.U. €	
50mm	1,0mm	0,170kg	CC-TP-X1-050-HDG	21,75€	●	CC-TP-X1-050-PG	16,10€	●
100mm	1,0mm	0,340kg	CC-TP-X1-100-HDG	24,10€	●	CC-TP-X1-100-PG	17,85€	●
150mm	1,0mm	0,600kg	CC-TP-X1-150-HDG	26,40€	●	CC-TP-X1-150-PG	19,55€	●
200mm	1,0mm	0,810kg	CC-TP-X1-200-HDG	28,85€	●	CC-TP-X1-200-PG	21,35€	●
300mm	1,0mm	1,470kg	CC-TP-X1-300-HDG	36,70€	●	CC-TP-X1-300-PG	27,90€	●
400mm	1,0mm	2,900kg	CC-TP-X1-400-HDG	49,75€	●	CC-TP-X1-400-PG	36,85€	●
500mm	1,0mm	4,190kg	CC-TP-X1-500-HDG	59,95€	●	CC-TP-X1-500-PG	43,65€	●
600mm	1,0mm	5,730kg	CC-TP-X1-600-HDG	61,85€	●	CC-TP-X1-600-PG	45,80€	●

● Artigo de stock habitual

● Artigo disponível por encomenda

Redução para Caminho Cabos

Acabamento: Sendzimir - EN 10346

Acabamento: Galvanizado a Quente - EN 1461

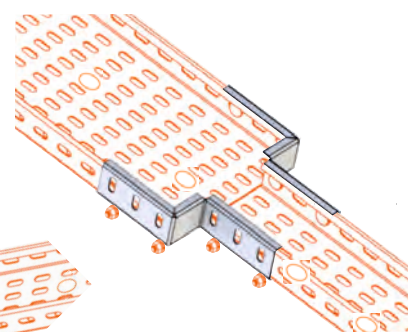
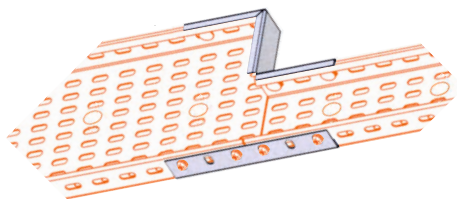
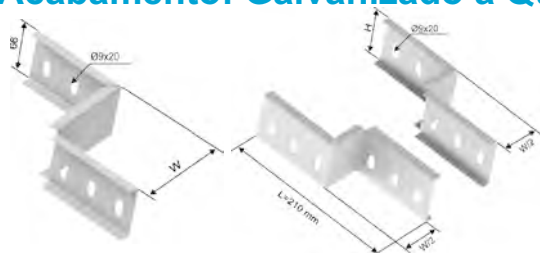

mm	mm	mm	kg	Código (Galvanizado Quente)	P.U. €		Código (Sendzimir)	P.U. €	
50mm	40mm	1,2mm	0,175kg	CC-RD-050-40-HDG	13,75€	●	CC-RD-050-40-PG	7,20€	●
50mm	60mm	1,2mm	0,350kg	CC-RD-050-60-HDG	15,50€	●	CC-RD-050-60-PG	7,75€	●
100mm	40mm	1,2mm	0,215kg	CC-RD-100-40-HDG	14,00€	●	CC-RD-100-40-PG	7,20€	●
100mm	60mm	1,2mm	0,285Kg	CC-RD-100-60-HDG	15,50€	●	CC-RD-100-60-PG	7,75€	●
200mm	60mm	1,2mm	0,380kg	CC-RD-200-60-HDG	18,80€	●	CC-RD-200-60-PG	9,45€	●
100mm	100mm	1,2mm	0,305Kg	CC-RD-100-100-HDG	200,20€	●	CC-RD-100-100-PG	9,75€	●
200mm	100mm	1,2mm	0,410kg	CC-RD-200-100-HDG	24,80€	●	CC-RD-200-100-PG	11,45€	●

Preço 1 Peça

Topo para Caminho Cabos

Acabamento: Sendzimir - EN 10346

Acabamento: Galvanizado a Quente - EN 1461

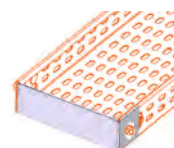
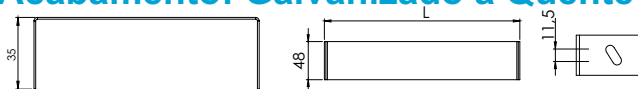

- Artigo de stock habitual
- Artigo disponível por encomenda

mm	mm	mm	kg	Código (Galvanizado Quente)	P.U. €		Código (Sendzimir)	P.U. €	
50mm	40mm	1,2mm	0,055kg	CC-TO-050-40-HDG	6,50€	●	CC-TO-050-40-PG	4,80€	●
100mm	40mm	1,2mm	0,060kg	CC-TO-100-40-HDG	7,30€	●	CC-TO-100-40-PG	5,40€	●
150mm	40mm	1,2mm	0,080kg	CC-TO-150-40-HDG	8,30€	●	CC-TO-150-40-PG	6,13€	●
200mm	40mm	1,2mm	0,115Kg	CC-TO-200-40-HDG	8,65€	●	CC-TO-200-40-PG	6,40€	●
300mm	40mm	1,2mm	0,140kg	CC-TO-300-40-HDG	10,10€	●	CC-TO-300-40-PG	7,45€	●
50mm	50mm	1,2mm	0,050Kg	CC-TO-050-50-HDG	6,95€	●	CC-TO-050-50-PG	5,15€	●
100mm	60mm	1,2mm	0,110kg	CC-TO-100-60-HDG	7,30€	●	CC-TO-100-60-PG	5,40€	●
150mm	60mm	1,2mm	0,125kg	CC-TO-150-60-HDG	8,30€	●	CC-TO-150-60-PG	6,15€	●
200mm	60mm	1,2mm	0,165kg	CC-TO-200-60-HDG	8,65€	●	CC-TO-200-60-PG	6,40€	●
300mm	60mm	1,2mm	0,220kg	CC-TO-300-60-HDG	10,10€	●	CC-TO-300-60-PG	7,45€	●
400mm	60mm	1,2mm	0,275kg	CC-TO-400-60-HDG	11,55€	●	CC-TO-400-60-PG	8,55€	●
500mm	60mm	1,2mm	0,325kg	CC-TO-500-60-HDG	13,00€	●	CC-TO-500-60-PG	9,60€	●
600mm	60mm	1,2mm	0,380kg	CC-TO-600-60-HDG	15,00€	●	CC-TO-600-60-PG	11,10€	●
100mm	100mm	1,2mm	0,150kg	CC-TO-100-100-HDG	10,00€	●	CC-TO-100-100-PG	7,50€	●
200mm	100mm	1,2mm	0,190kg	CC-TO-200-100-HDG	10,80€	●	CC-TO-200-100-PG	8,00€	●
300mm	100mm	1,2mm	0,220kg	CC-TO-300-100-HDG	12,60€	●	CC-TO-300-100-PG	9,30€	●
400mm	100mm	1,2mm	0,275kg	CC-TO-400-100-HDG	14,90€	●	CC-TO-400-100-PG	10,55€	●
500mm	100mm	1,2mm	0,325kg	CC-TO-500-100-HDG	16,40€	●	CC-TO-500-100-PG	11,60€	●
600mm	100mm	1,2mm	0,380kg	CC-TO-600-100-HDG	18,00€	●	CC-TO-600-100-PG	12,60€	●

- Artigo de stock habitual
- Artigo disponível por encomenda

Separador para Caminho Cabos Acabamento: Sendzimir - EN 10346 Acabamento: Galvanizado a Quente - EN 1461

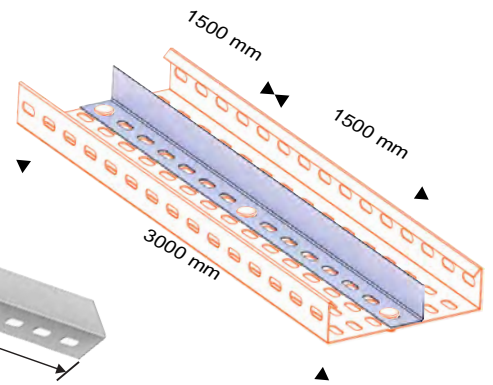
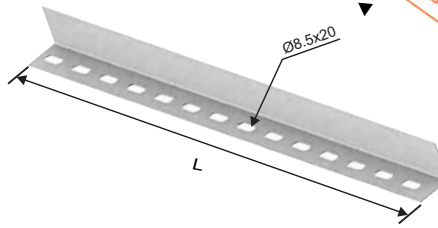
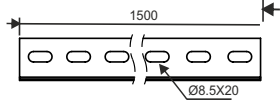
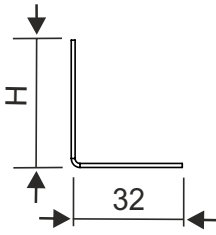

mm	mm	mm	kg	Código (Galvanizado Quente)	P.U./mt €	Código (Sendzimir)	P.U./mt €
40mm	0,8mm	3000mm	0,560kg	CC-SP-040-08-HDG	8,10€	CC-SP-040-08-PG	5,95€
60mm	0,8mm	3000mm	0,730kg	CC-SP-060-08-HDG	8,45€	CC-SP-060-08-PG	6,25€
100mm	0,8mm	3000mm	1,060kg	CC-SP-100-08-HDG	11,50€	CC-SP-100-08-PG	8,50€

- Artigo de stock habitual
- Artigo disponível por encomenda

Descida de Cabos para Caminho Cabos Acabamento: Sendzimir - EN 10346 Acabamento: Galvanizado a Quente - EN 1461

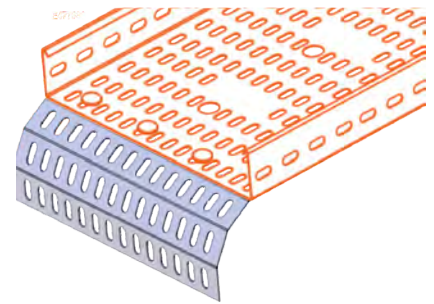
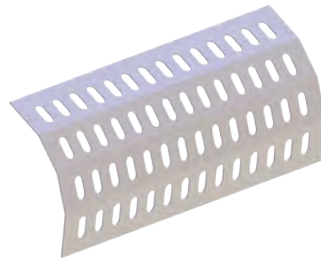
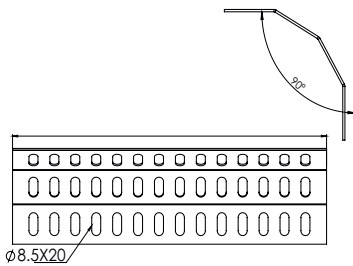

mm	mm	kg	Código (Galvanizado Quente)	P.U. €	Código (Sendzimir)	P.U. €
50mm	1,5mm	0,070kg	CC-DES-050-HDG	9,50€	CC-DES-050-PG	7,10€
100mm	1,5mm	0,145kg	CC-DES-100-HDG	18,40€	CC-DES-100-PG	13,60€
150mm	1,5mm	0,220kg	CC-DES-150-HDG	28,65€	CC-DES-150-PG	21,20€
200mm	1,5mm	0,290kg	CC-DES-200-HDG	36,80€	CC-DES-200-PG	27,25€
300mm	1,5mm	0,435kg	CC-DES-300-HDG	55,30€	CC-DES-300-PG	40,95€
400mm	2,0mm	0,775kg	CC-DES-400-HDG	73,45€	CC-DES-400-PG	54,40€
500mm	2,0mm	0,970kg	CC-DES-500-HDG	91,60€	CC-DES-500-PG	67,85€
600mm	2,0mm	1,160kg	CC-DES-600-HDG	110,60€	CC-DES-600-PG	81,90€

- Artigo de stock habitual
- Artigo disponível por encomenda

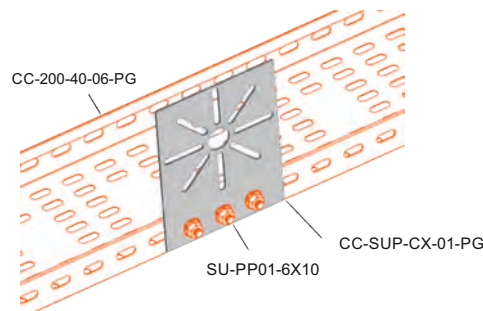
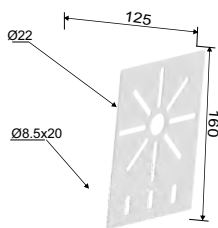

mm	mm	mm	kg	Código (Galvanizado Quente)	P.U. €	Código (Sendzimir)	P.U. €
160mm	125mm	1,5mm	0,20kg	CC-SUP-CX-01-HDG	4,50€	CC-SUP-CX-01-PG	3,35€

- Artigo de stock habitual
- Artigo disponível por encomenda

Caminho Cabos de Varão Electrosoldado com Aba 35mm

Acabamento: Electrozincado - EN 2081
Acabamento: Galvanizado a Quente - EN 1461

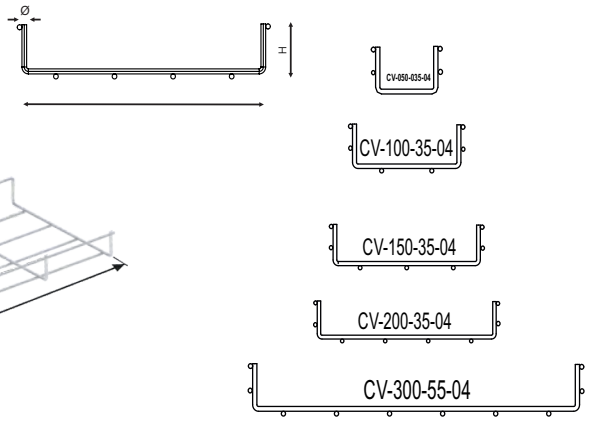
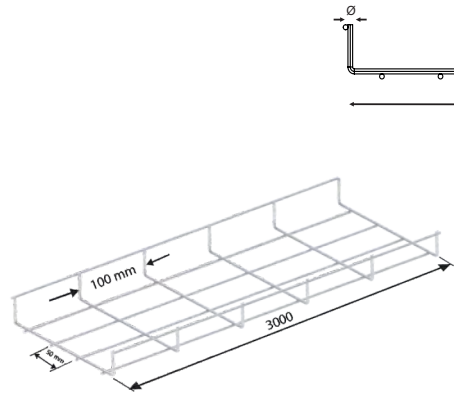
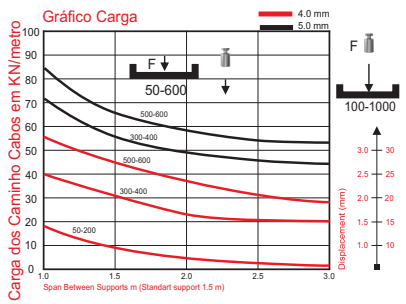

mm	mm	mm	mm	kg/mt	Código(Galvanizado Quente)	P.U./mt €	Código(Eletrozincado)	P.U./mt €
50	35	4,0	3000	0,760	CV-050-35-04-HDG	8,16€	CV-050-35-04-EG	6,53€
100	35	4,0	3000	1,080	CV-100-35-04-HDG	8,50€	CV-100-35-04-EG	6,13€
150	35	4,0	3000	1,330	CV-150-35-04-HDG	9,20€	CV-150-35-04-EG	6,97€
200	35	4,0	3000	1,580	CV-200-35-04-HDG	9,78€	CV-200-35-04-EG	7,83€
300	35	4,0	3000	2,090	CV-300-35-04-HDG	13,10€	CV-300-35-04-EG	10,53€

- Artigo de stock habitual
- Artigo disponível por encomenda

Caminho Cabos de Varão Eletrosoldado com Aba 55mm

Acabamento: Electrozincado - EN 2081
Acabamento: Galvanizado a Quente - EN 1461

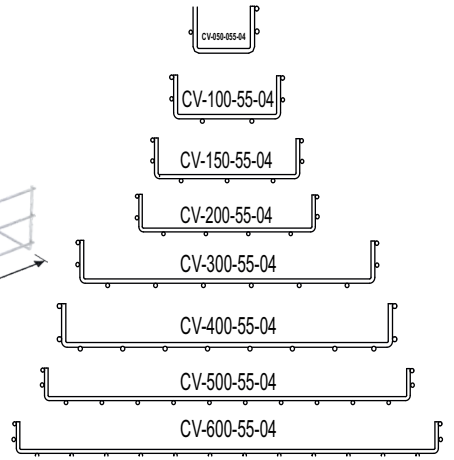
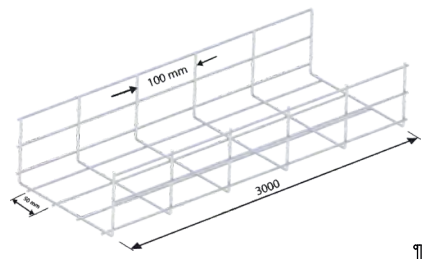
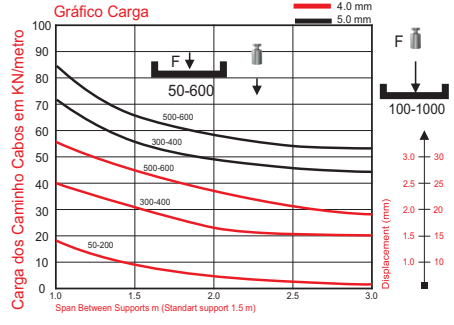

mm	mm	mm	mm	kg/mt	Código(Galvanizado Quente)	P.U./mt €	Código(Eletrozincado)	P.U./mt €
50	55	4,0	3000	0,855	CV-050-55-04-HDG	8,30€	CV-050-55-04-EG	6,12€
100	55	4,0	3000	1,170	CV-100-55-04-HDG	8,90€	CV-100-55-04-EG	6,50€
150	55	4,0	3000	1,420	CV-150-55-04-HDG	9,45€	CV-150-55-04-EG	7,25€
200	55	4,0	3000	1,680	CV-200-55-04-HDG	11,10€	CV-200-55-04-EG	8,85€
300	55	4,0	3000	2,180	CV-300-55-04-HDG	13,55€	CV-300-55-04-EG	10,85€
400	55	4,0	3000	2,680	CV-400-55-04-HDG	24,80€	CV-400-55-04-EG	16,75€
500	55	4,0	3000	3,180	CV-500-55-04-HDG	30,85€	CV-500-55-04-EG	20,40€
600	55	4,0	3000	3,690	CV-600-55-04-HDG	31,50€	CV-600-55-04-EG	22,20€

- Artigo de stock habitual
- Artigo disponível por encomenda

Caminho Cabos de Varão Eletrosoldado com Aba 100mm

Acabamento: Electrozincado - EN 2081

Acabamento: Galvanizado a Quente - EN 1461

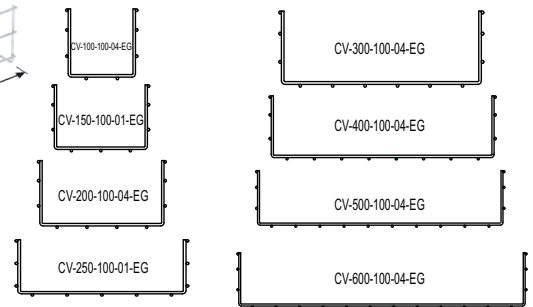
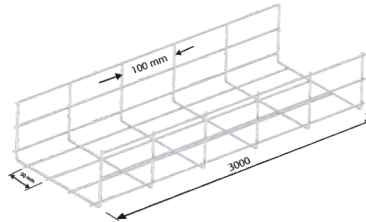
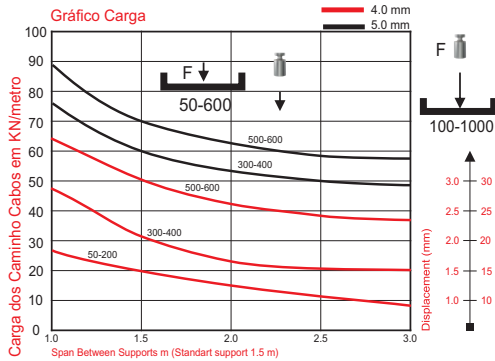
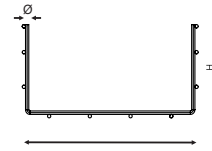

mm	mm	mm	mm	kg/mt	Código (Galvanizado Quente)	P.U./mt €	Código (Electrozincado)	P.U./mt €
100mm	100mm	4,0mm	3000mm	1,170kg/mt	CV-100-100-04-HDG	15,50€	CV-100-100-04-EG	11,50€
150mm	100mm	4,0mm	3000mm	1,420kg/mt	CV-150-100-04-HDG	16,50€	CV-150-100-04-EG	12,00€
200mm	100mm	4,0mm	3000mm	1,680kg/mt	CV-200-100-04-HDG	17,90€	CV-200-100-04-EG	13,50€
300mm	100mm	4,0mm	3000mm	2,180kg/mt	CV-300-100-04-HDG	19,95€	CV-300-100-04-EG	15,50€
400mm	100mm	4,0mm	3000mm	2,680kg/mt	CV-400-100-04-HDG	29,85€	CV-400-100-04-EG	23,50€
500mm	100mm	4,0mm	3000mm	3,180kg/mt	CV-500-100-04-HDG	30,90€	CV-500-100-04-EG	28,00€
600mm	100mm	4,0mm	3000mm	3,690kg/mt	CV-600-100-04-HDG	36,80€	CV-600-100-04-EG	30,50€

- Artigo de stock habitual
- Artigo disponível por encomenda

Tampa para Caminho Cabos / Calha Varão

Acabamento: Sendzimir - EN 2081

Acabamento: Galvanizado a Quente - EN 1461

Tampa de Encaixe por pressão,
Não necessita de Clip fixação

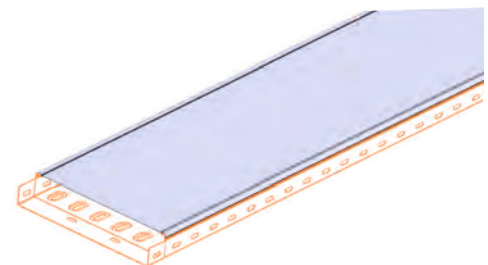

mm	mm	mm	kg/mt	Código(Galvanizado Quente)	P.U./mt €	Código(Sendzimir)	P.U./mt €
50mm	0,6mm	3000mm	0,270kg/mt	CV-TP-050-07-HDG(p/Cam.Cabos de Varão)	4,42€	CV-TP-050-06-PG(p/Cam.Cabos Varão)	2,55€
50mm	0,6mm	3000mm	0,270kg/mt	CC-TP-050-07-HDG	4,42€	CC-TP-050-06-PG	2,55€
100mm	0,6mm	3000mm	0,470kg/mt	CC-TP-100-07-HDG	6,32€	CC-TP-100-06-PG	3,99€
150mm	0,6mm	3000mm	0,660kg/mt	CC-TP-150-07-HDG	8,50€	CC-TP-150-06-PG	5,45€
200mm	0,7mm	3000mm	1,030kg/mt	CC-TP-200-08-HDG	10,75€	CC-TP-200-07-PG	6,91€
300mm	0,8mm	3000mm	1,750kg/mt	CC-TP-300-08-HDG	19,50€	CC-TP-300-08-PG	12,68€
400mm	0,8mm	3000mm	2,300kg/mt	CC-TP-400-08-HDG	25,30€	CC-TP-400-08-PG	16,49€
500mm	1,0mm	3000mm	3,670kg/mt	CC-TP-500-10-HDG	38,50€	CC-TP-500-10-PG	25,11€
600mm	1,0mm	3000mm	4,380kg/mt	CC-TP-600-10-HDG	45,60€	CC-TP-600-10-PG	29,95€

- Artigo de stock habitual
- Artigo disponível por encomenda

Caminho Cabos de Varão Inox com Aba 35mm Acabamento: Inox (316 / 304)

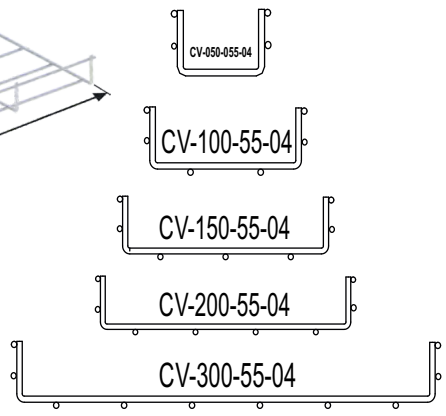
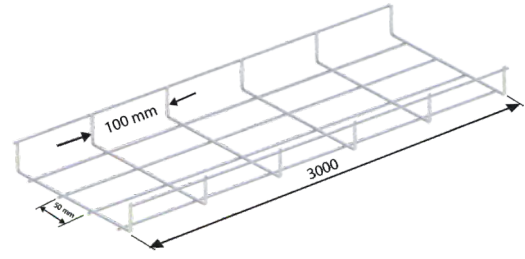
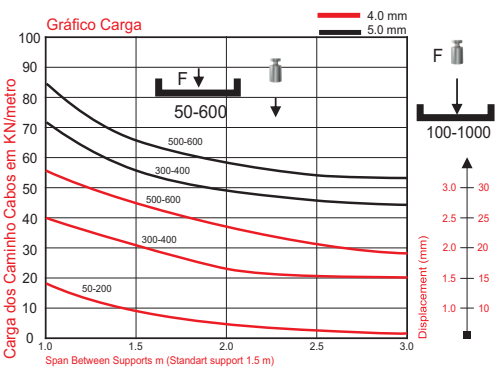
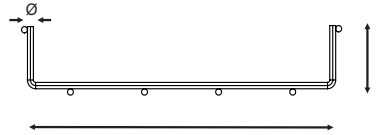

mm	mm	mm	mm	kg /mt	Código (Inox 316)	P.U./mt €	Código (Inox 304)	P.U./mt €
50mm	35mm	4,0mm	3000mm	0,760kg/mt	CV-050-35-04-SS316	30,04€	CV-050-35-04-SS304	16,50€
100mm	35mm	4,0mm	3000mm	1,080kg/mt	CV-100-35-04-SS316	42,55€	CV-100-35-04-SS304	18,50€
150mm	35mm	4,0mm	3000mm	1,330kg/mt	CV-150-35-04-SS316	48,80€	CV-150-35-04-SS304	19,90€
200mm	35mm	4,0mm	3000mm	1,580kg/mt	CV-200-35-04-SS316	53,90€	CV-200-35-04-SS304	22,34€
300mm	35mm	4,0mm	3000mm	2,090kg/mt	CV-300-35-04-SS316	68,20€	CV-300-35-04-SS304	35,40€

- Artigo de stock habitual
- Artigo disponível por encomenda

Caminho Cabos de Varão Inox com Aba 55mm Acabamento: Inox (316 / 304)

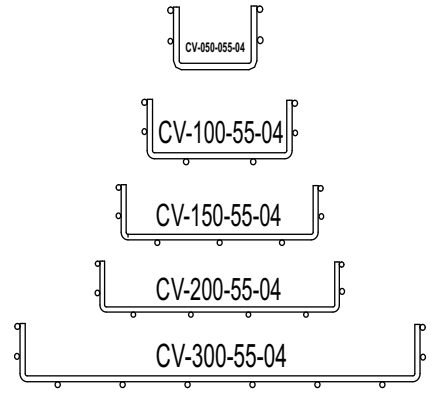
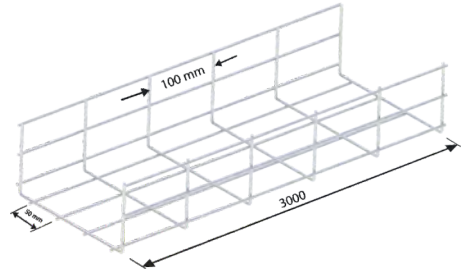
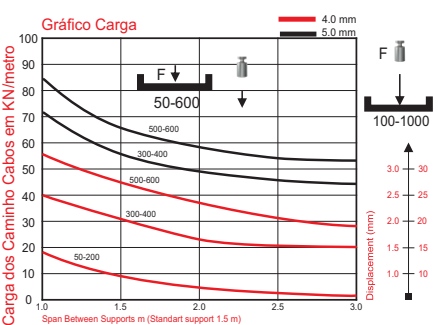

mm	mm	mm	mm	kg /mt	Código (Inox 316)	P.U./mt €	Código (Inox 304)	P.U./mt €
50mm	55mm	3000mm	4,0mm	0,855g/mt	CV-050-55-04-SS316	33,50€	CV-050-55-04-SS304	18,10€
100mm	55mm	3000mm	4,0mm	1,170kg/mt	CV-100-55-04-SS316	45,30€	CV-100-55-04-SS304	22,50€
150mm	55mm	3000mm	4,0mm	1,420kg/mt	CV-150-55-04-SS316	49,50€	CV-150-55-04-SS304	26,60€
200mm	55mm	3000mm	4,0mm	1,680kg/mt	CV-200-55-04-SS316	55,60€	CV-200-55-04-SS304	34,40€
300mm	55mm	3000mm	4,0mm	2,180kg/mt	CV-300-55-04-SS316	72,80€	CV-300-55-04-SS304	44,30€
400mm	55mm	3000mm	4,0mm	2,580kg/mt	CV-400-55-04-SS316	85,90€	CV-400-55-04-SS304	54,65€
500mm	55mm	3000mm	4,0mm	3,180kg/mt	CV-500-55-04-SS316	125,30€	CV-500-55-04-SS304	66,09€
600mm	55mm	3000mm	4,0mm	3,690kg/mt	CV-600-55-04-SS316	150,00€	CV-600-55-04-SS304	81,14€

- Artigo de stock habitual
- Artigo disponível por encomenda

Tampa para Caminho Cabos / Calha Varão Inox

Acabamento: Inox (316 / 304)

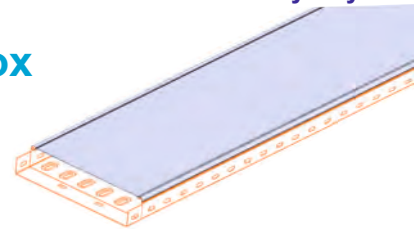
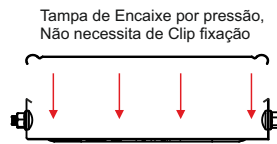

mm	mm	mm	kg/mt	Código (Inox 316)	P.U./mt €	Código (Inox 304)	P.U./mt €
50mm	0,6mm	3000mm	0,270kg/mt	CC-TP-050-06-SS316	25,50€	CC-TP-050-06-SS304	17,25€
100mm	0,6mm	3000mm	0,470kg/mt	CC-TP-100-06-SS316	30,70€	CC-TP-100-06-SS304	19,50€
150mm	0,5mm	3000mm	0,660kg/mt	CC-TP-150-06-SS316	39,80€	CC-TP-150-06-SS304	27,80€
200mm	0,7mm	3000mm	1,030kg/mt	CC-TP-200-07-SS316	49,61€	CC-TP-200-07-SS304	32,30€
300mm	0,8mm	3000mm	1.750kg/mt	CC-TP-300-08-SS316	90,04€	CC-TP-300-08-SS304	53,80€
400mm	0,9mm	3000mm	2,840kg/mt	CC-TP-400-09-SS316	120,95€	CC-TP-400-09-SS304	82,76€
500mm	0,9mm	3000mm	4,610kg/mt	CC-TP-500-09-SS316	150,80€	CC-TP-500-09-SS304	120,95€
600mm	0,9mm	3000mm	5,500kg/mt	CC-TP-600-09-SS316	190,85€	CC-TP-600-09-SS304	150,80€

- Artigo de stock habitual
- Artigo disponível por encomenda

Perfil Lateral p/Cabos de Escada Modular

Acabamento: Sendzimir - EN 10346

Acabamento: Galvanizado a Quente - EN EN 1461

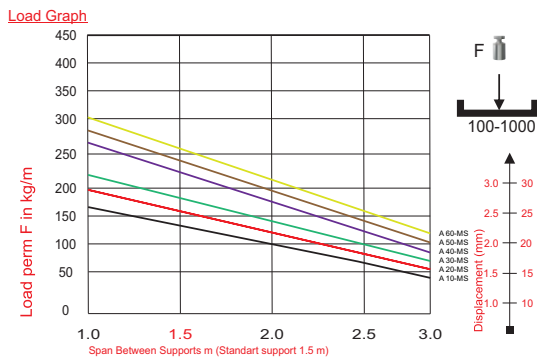
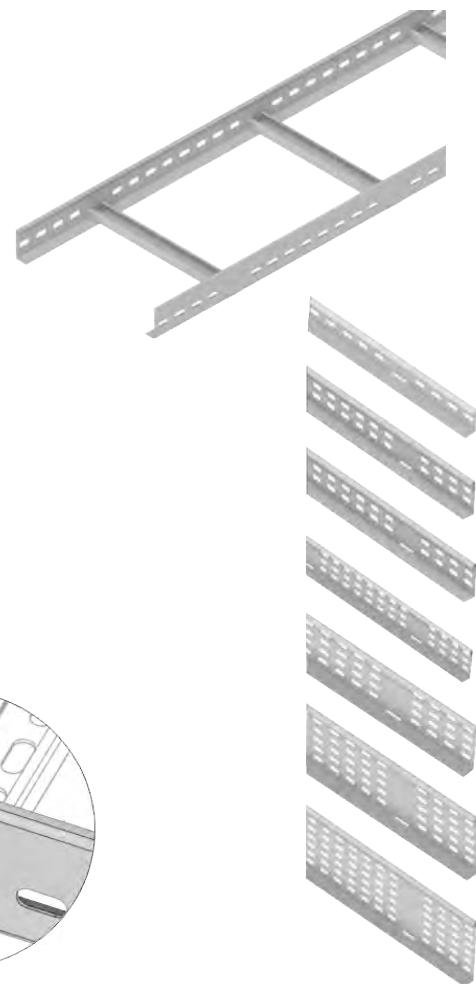
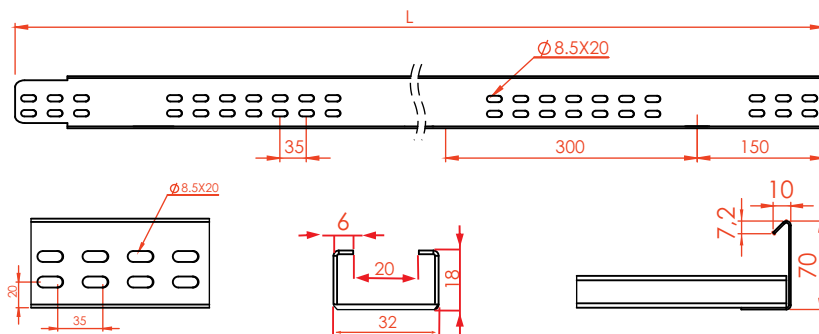

mm	mm	mm	kg/mt	Código (Galvanizado Quente)	P.U./mt €	Código (Sendzimir)	P.U./mt €
60mm	1,0mm	3000mm	0,765kg/mt	CE-PER-060-10-HDG	9,68€/mt	CE-PER-060-10-PG	7,15€/mt
100mm	1,0mm	3000mm	0,920kg/mt	CE-PER-100-10-HDG	13,30€/mt	CE-PER-100-10-PG	9,85€/mt

- Artigo de stock habitual
- Artigo disponível por encomenda

Degraus para Caminho Cabos de Escada Modular
Acabamento: Sendzimir - EN 10346
Acabamento: Galvanizado a Quente - EN EN 1461

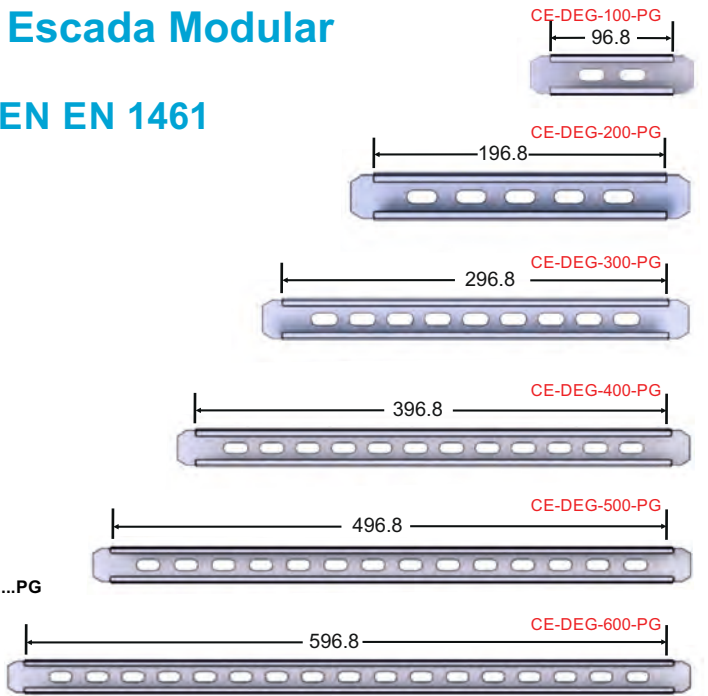
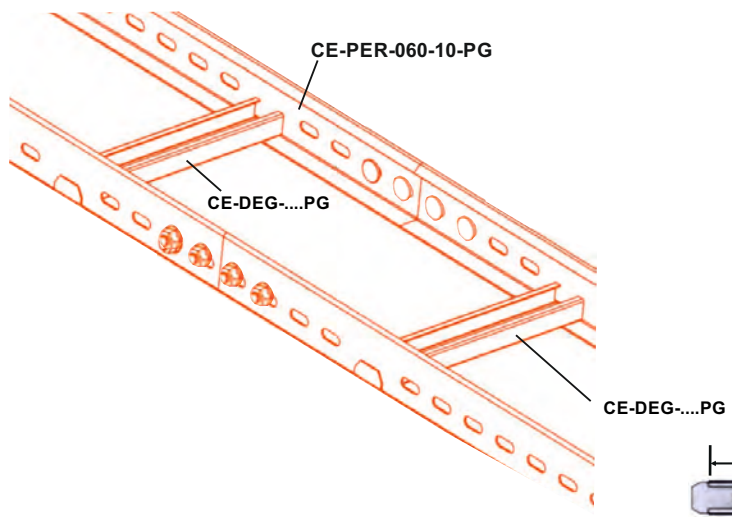

mm	mm	mm	mm	kg	Código (Galvanizado Quente)	P.U. €		Código (Sendzimir)	P.U. €	
32mm	32mm	1,0mm	196,8mm	0,120kg	CE-DEG-200-HDG	2,00€	●	CE-DEG-200-PG	1,45€	●
32mm	32mm	1,0mm	298,8mm	0,170kg	CE-DEG-300-HDG	2,60€	●	CE-DEG-300-PG	1,90€	●
32mm	32mm	1,0mm	396,8mm	0,260kg	CE-DEG-400-HDG	4,00€	●	CE-DEG-400-PG	2,95€	●
32mm	32mm	1,0mm	496,8mm	0,320kg	CE-DEG-500-HDG	4,95€	●	CE-DEG-500-PG	3,65€	●
32mm	32mm	1,0mm	296,8mm	0,400kg	CE-DEG-600-HDG	5,75€	●	CE-DEG-600-PG	4,25€	●

- Artigo de stock habitual
- Artigo disponível por encomenda

União Reta / Angular p/ Cabos de Escada Modular
Acabamento: Sendzimir - EN 10346
Acabamento: Galvanizado a Quente - EN EN 1461

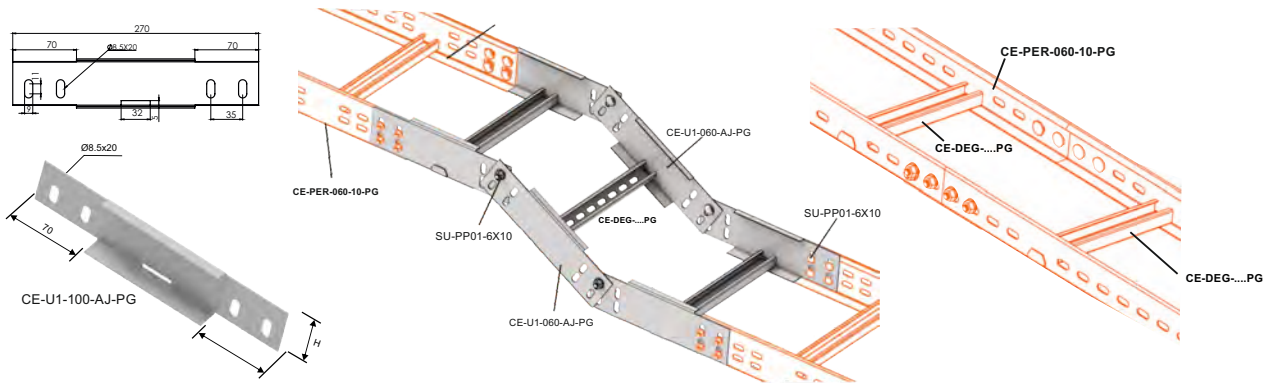

mm	mm	mm	kg	Código (Galvanizado Quente)	P.U. €		Código (Sendzimir)	P.U. €	
60mm	270mm	1,2mm	0,260kg	CE-U1-060-AJ-HDG	7,90€	●	CE-U1-060-AJ-PG	5,85€	●
100mm	270mm	1,2mm	0,345kg	CE-U1-100-AJ-HDG	11,10€	●	CE-U1-100-AJ-PG	8,25€	●

- Artigo de stock habitual
- Artigo disponível por encomenda

União Lateral p/Caminho Cabos de Varão

Acabamento: Sendzimir - EN 10346

Acabamento: Galvanizado a Quente - EN EN 1461

Acabamento: Inox

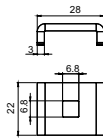
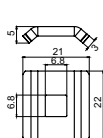
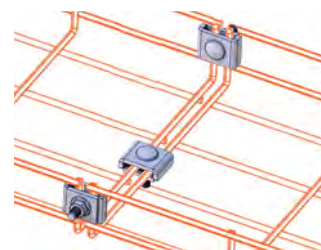

Código	mm	mm	mm	kg	Acabamento	P.U. €	
CV-U1	28mm	22mm	3,0mm	0,075kg	Sendzimir	1,13€	●
CV-U1-HDG	28mm	22mm	3,0mm	0,075kg	Galvanizado Quente	2,95€	●
CV-U1-SS304	28mm	22mm	3,0mm	0,075kg	Inox 304	5,30€	●

União Ligeira p/Caminho Cabos de Varão



Código	mm	mm	mm	kg	Acabamento	P.U. €	
CV-U11	28mm	22mm	3,0mm	0,075kg	Sendzimir	0,70€	●

Fixação para Suporte p/Caminho Cabos de Varão



Código	mm	mm	mm	kg	Acabamento	P.U. €	
CV-U12	28mm	22mm	3,0mm	0,075kg	Sendzimir	0,85€	●

Anilha Alta p/Caminho Cabos de Varão



Código	mm	mm	mm	kg	Acabamento	P.U. €	
CV-U20	28mm	22mm	3,0mm	0,075kg	Sendzimir	0,45€	●

Anilha Baixa p/Caminho Cabos de Varão



Código	mm	mm	mm	kg	Acabamento	P.U. €	
CV-U30	28mm	22mm	3,0mm	0,075kg	Sendzimir	0,40€	●

União Rápida Lateral p/Caminho Cabos de Varão

Acabamento: Sendzimir - EN 10346

Acabamento: Galvanizado a Quente - EN EN 1461

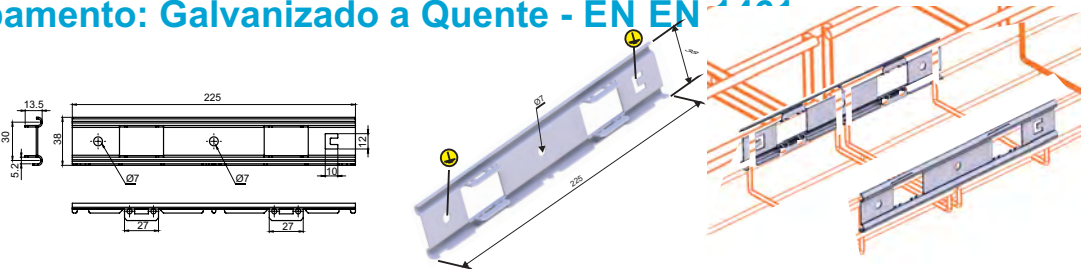

Código	mm	mm	mm	kg	Acabamento	P.U. €	
CV-U2-PG	225mm	30mm	0,90mm	0,075kg	Sendzimir	2,60€	●
CV-U2-HDG	225mm	30mm	0,90mm	0,075kg	Galvanizado Quente	7,00€	●

- Artigo de stock habitual
- Artigo disponível por encomenda

Suspensão Lateral para Caminho Cabos de Varão

Acabamento: Sendzimir - EN 10346

Acabamento: Galvanizado a Quente - EN 1461

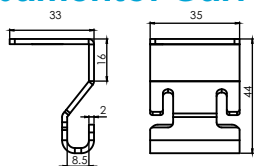

CV-SP-01-PG

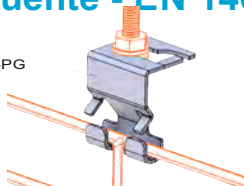

CV-SP-01-PG



Código	mm	mm	mm	kg	Acabamento	P.U. €	
CV-SP-01-PG	35mm	44mm	2,0mm	0,045kg	Sendzimir	1,90€	●
CV-SP-01HDG	35mm	44mm	2,0mm	0,045kg	Galvanizado Quente	2,60€	●

- Artigo de stock habitual
- Artigo disponível por encomenda

Suspensão Central para Caminho Cabos de Varão

Acabamento: Sendzimir - EN 10346

Acabamento: Galvanizado a Quente - EN EN 1461

Acabamento: Inox

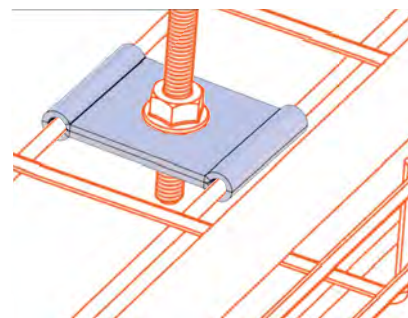
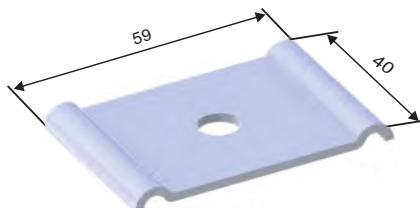
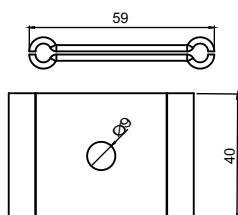

Código	mm	mm	mm	kg	Acabamento	P.U. €	
CV-SP-02-PG	59mm	40mm	2,0mm	0,040kg	Sendzimir	2,00€	●
CV-SP-02-HDG	59mm	40mm	2,0mm	0,040kg	Galvanizado Quente	2,70€	●
CV-SP-02-SS304	59mm	40mm	2,0mm	0,040kg	Inox 304	4,80€	●

- Artigo de stock habitual
- Artigo disponível por encomenda

Suporte para Caixa Derivação para Caminho Cabos de Varão

Acabamento: Sendzimir - EN 10346

Acabamento: Galvanizado a Quente - EN 1461

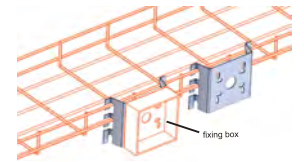
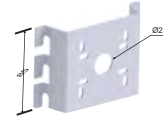
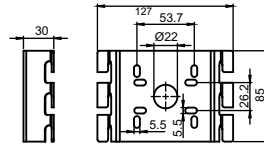

Código	mm	mm	mm	kg	Acabamento	P.U. €	
CV-SUP-CX-01-PG	127mm	85mm	2,0mm	0,019kg	Sendzimir	4,00€	●
CV-SUP-CX-01-HDG	127mm	85mm	2,0mm	0,019kg	Galvanizado Quente	7,10€	●
CV-SUP-CX-01-SS304	127mm	85mm	2,0mm	0,019kg	Inox 304	20,00€	●

● Artigo de stock habitual

● Artigo disponível por encomenda

Suporte Longo para Caixa Derivação para Caminho Cabos de Varão

Acabamento: Sendzimir - EN 10346

Acabamento: Galvanizado a Quente - EN 1461

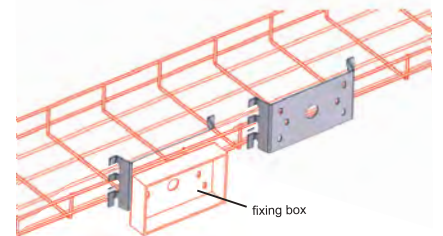
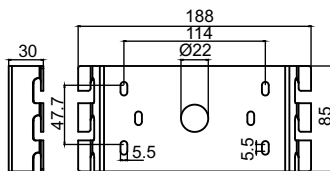

Código	mm	mm	mm	kg	Acabamento	P.U. €	
CV-SUP-CX-02-PG	188mm	85mm	2,0mm	0,027kg	Sendzimir	6,50€	●
CV-SUP-CX-02-HDG	188mm	85mm	2,0mm	0,027kg	Galvanizado Quente	10,60€	●
CV-SUP-CX-02-SS304	188mm	85mm	2,0mm	0,027kg	Inox 304	35,00€	●

● Artigo de stock habitual

● Artigo disponível por encomenda

Borne Terra para Caminho Cabos



Código	Fixação	Cabo	Barra Conexão	Acabamento	P.U. €
CC-BORNE-TE-01	M6	10-35mm ²	8mm ²	Latão	4,80€

Suporte em L para Caminho Cabos Chapa / Varão

Acabamento: Sendzimir - EN 10346

Acabamento: Galvanizado a Quente - EN 61537

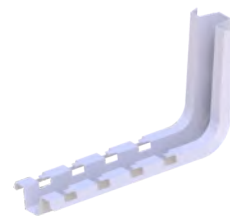
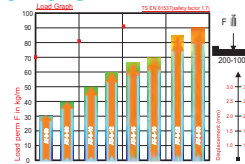

mm	mm	mm	kg	Código(Galvanizado Quente)	P.U. €	Código(Sendzimir)	P.U. €
100mm	75mm	1,5mm	0,145kg	SU-SUP-02-L100-HDG	7,50€	SU-SUP-02-L100-PG	5,55€
150mm	75mm	1,5mm	0,220kg	SU-SUP-02-L150-HDG	9,55€	SU-SUP-02-L150-PG	7,05€
200mm	75mm	1,5mm	0,420kg	SU-SUP-02-L200-HDG	10,55€	SU-SUP-02-L200-PG	7,80€
300mm	110mm	2,0mm	0,670kg	SU-SUP-02-L300-HDG	12,10€	SU-SUP-02-L300-PG	8,90€
400mm	110mm	2,0mm	0,800kg	SU-SUP-02-L400-HDG	13,95€	SU-SUP-02-L400-PG	10,30€
500mm	110mm	2,0mm	0,950kg	SU-SUP-02-L500-HDG	16,15€	SU-SUP-02-L500-PG	11,95€
600mm	110mm	2,0mm	0,950kg	SU-SUP-02-L600-HDG	20,25€	SU-SUP-02-L600-PG	15,00€

- Artigo de stock habitual
- Artigo disponível por encomenda

Suporte em L para Caminho Cabos Chapa / Varão

Acabamento: Inox 304 - EN 10346



mm	mm	mm	kg	Código(Inox 304)	P.U. €
100mm	75mm	1,5mm	0,145kg	SU-SUP-02-L100-SS304	18,50€
150mm	75mm	1,5mm	0,220kg	SU-SUP-02-L150-SS304	20,50€
200mm	75mm	1,5mm	0,420kg	SU-SUP-02-L200-SS304	23,30€
300mm	110mm	2,0mm	0,670kg	SU-SUP-02-L300-SS304	30,40€
400mm	110mm	2,0mm	0,800kg	SU-SUP-02-L400-SS304	35,00€
500mm	110mm	2,0mm	0,950kg	SU-SUP-02-L500-SS304	44,00€
600mm	110mm	2,0mm	0,950kg	SU-SUP-02-L600-SS304	49,30€

- Artigo de stock habitual
- Artigo disponível por encomenda

Suporte em C para Caminho Cabos Chapa / Varão

Acabamento: Sendzimir - EN 10346

Acabamento: Galvanizado a Quente - EN 61537

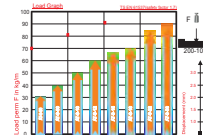

mm	mm	mm	kg	Código(Galvanizado Quente)	P.U. €	Código(Sendzimir)	P.U. €
100mm	75mm	1,5mm	0,145kg	SU-SUP-02-C100-HDG	10,15€	SU-SUP-02-C100-PG	7,50€
150mm	75mm	1,5mm	0,220kg	SU-SUP-02-C150-HDG	12,70€	SU-SUP-02-C150-PG	9,40€
200mm	75mm	1,5mm	0,420kg	SU-SUP-02-C200-HDG	13,40€	SU-SUP-02-C200-PG	9,90€
300mm	110mm	2,0mm	0,670kg	SU-SUP-02-C300-HDG	14,85€	SU-SUP-02-C300-PG	11,00€
400mm	110mm	2,0mm	0,800kg	SU-SUP-02-C400-HDG	18,40€	SU-SUP-02-C400-PG	13,60€
500mm	110mm	2,0mm	0,950kg	SU-SUP-02-C500-HDG	31,25€	SU-SUP-02-C500-PG	23,15€
600mm	110mm	2,0mm	0,950kg	SU-SUP-02-C600-HDG	34,15€	SU-SUP-02-C600-PG	25,30€

- Artigo de stock habitual
- Artigo disponível por encomenda

Borne de Terra para Caminho Cabos de Varão

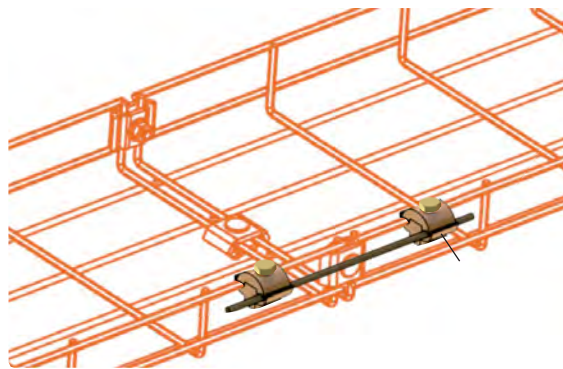
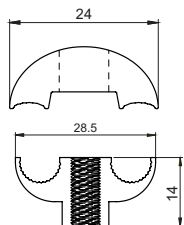

Código	mm	mm	mm	kg	Acabamento	P.U. €
CV-BORNE-TE-02	24mm	14mm	2,0mm	0,005kg	Latão	8,60€

Suporte Reforçado Eletro Galvanizado p/Cam.Cabos Chapa / Varão Acabamento: Galvanizado a Quente - EN 61537

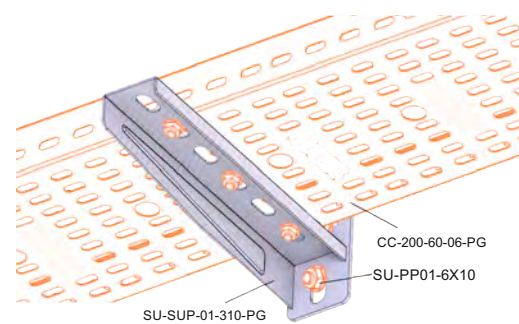
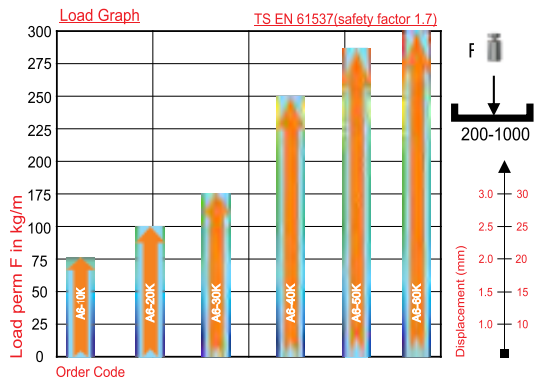
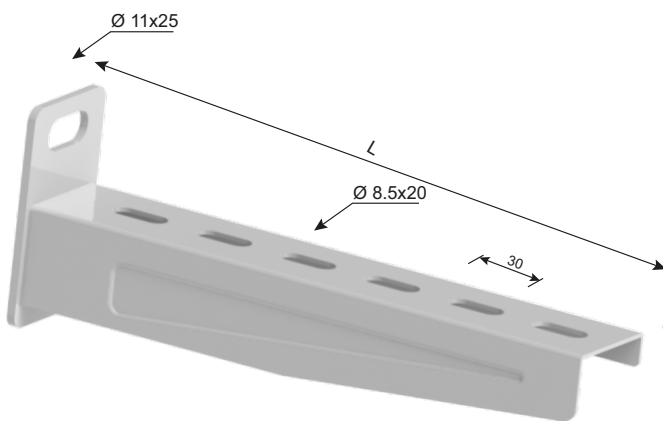
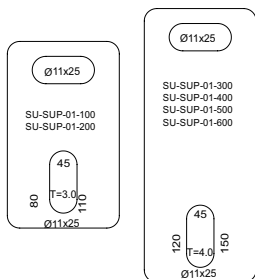

mm	mm	mm	kg	Código (Galvanizado Quente)	P.U. €	Código (Sendzimir)	P.U. €
110mm	75mm	1,5mm	0,145kg	SU-SUP-01-110-HDG	6,30€	SU-SUP-01-110-PG	4,65€
210mm	75mm	1,5mm	0,220kg	SU-SUP-01-210-HDG	7,40€	SU-SUP-01-210-PG	5,45€
310mm	75mm	1,5mm	0,420kg	SU-SUP-01-310-HDG	10,40€	SU-SUP-01-310-PG	7,70€
410mm	110mm	2,0mm	0,670kg	SU-SUP-01-410-HDG	12,10€	SU-SUP-01-410-PG	8,90€
510mm	110mm	2,0mm	0,800kg	SU-SUP-01-510-HDG	19,50	SU-SUP-01-510-PG	14,45€
610mm	110mm	2,0mm	0,950kg	SU-SUP-01-610-HDG	22,15€	SU-SUP-01-610-PG	16,40€

- Artigo de stock habitual
- Artigo disponível por encomenda

Distanciadores para Caminho Cabos Chapa / Varão

Acabamento: Sendzimir - EN 10346

Acabamento: Galvanizado a Quente - EN 61537

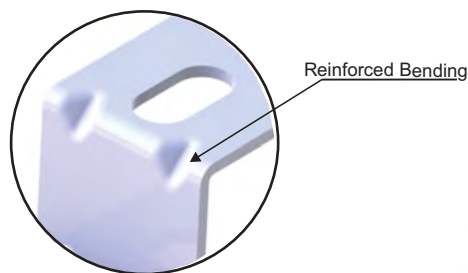

Reinforced Bending

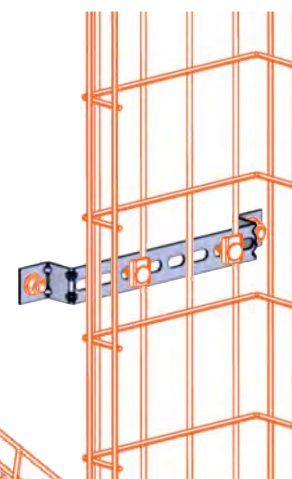
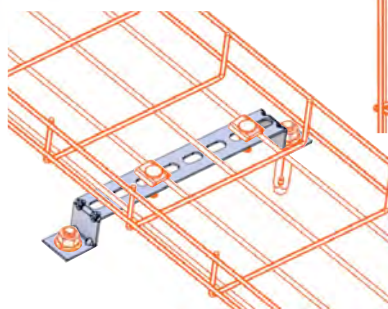
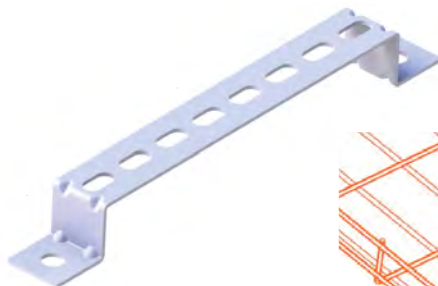
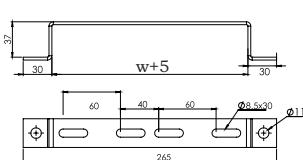

mm	mm	mm	kg	Código (Galvanizado Quente)	P.U. €	Código (Sendzimir)	P.U. €
100mm	40mm	2,5mm	0,150kg	SU-DIST-100-040-HDG	5,10€	SU-DIST-100-040-PG	3,75€
150mm	40mm	2,5mm	0,175kg	SU-DIST-150-040-HDG	5,67€	SU-DIST-150-040-PG	4,20€
200mm	40mm	2,5mm	0,200kg	SU-DIST-200-040-HDG	6,15€	SU-DIST-200-040-PG	4,55€
300mm	40mm	2,5mm	0,270kg	SU-DIST-300-040-HDG	6,90€	SU-DIST-300-040-PG	5,10€
400mm	40mm	3,0mm	0,385kg	SU-DIST-400-040-HDG	7,30€	SU-DIST-400-040-PG	5,40€
500mm	40mm	3,0mm	0,460kg	SU-DIST-500-040-HDG	8,10€	SU-DIST-500-040-PG	6,00€
600mm	40mm	3,0mm	0,525kg	SU-DIST-600-040-HDG	9,00€	SU-DIST-600-040-PG	6,65€

● Artigo de stock habitual

● Artigo disponível por encomenda

Suspensão Central para Caminho Cabos Chapa / Escada

Acabamento: Sendzimir - EN 10346

Acabamento: Galvanizado a Quente - EN 61537

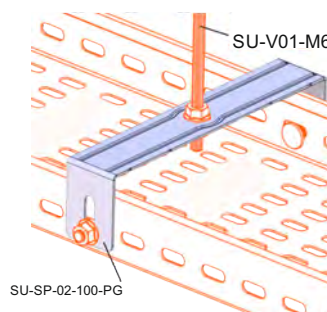
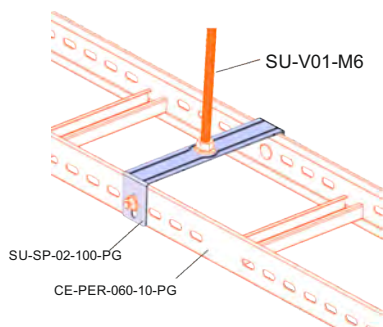
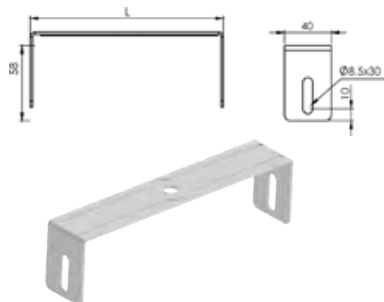

mm	mm	mm	kg	Código (Galvanizado Quente)	P.U. €	Código (Sendzimir)	P.U. €
50mm	58mm	1,2mm	0,070kg	SU-SP-02-050-HDG	6,75€	SU-SP-02-050-PG	5,00€
100mm	58mm	1,2mm	0,075kg	SU-SP-02-100-HDG	7,50€	SU-SP-02-100-PG	5,55€
150mm	58mm	1,2mm	0,105kg	SU-SP-02-150-HDG	8,00€	SU-SP-02-150-PG	6,00€
200mm	58mm	1,2mm	0,165kg	SU-SP-02-200-HDG	8,55€	SU-SP-02-200-PG	6,30€
300mm	58mm	1,2mm	0,195kg	SU-SP-02-300-HDG	9,65€	SU-SP-02-300-PG	7,50€

● Artigo de stock habitual

● Artigo disponível por encomenda

Suporte Lateral para Caminho Cabos Chapa / Calha Escada

Acabamento: Sendzimir - EN 10346

Acabamento: Galvanizado a Quente - EN 61537

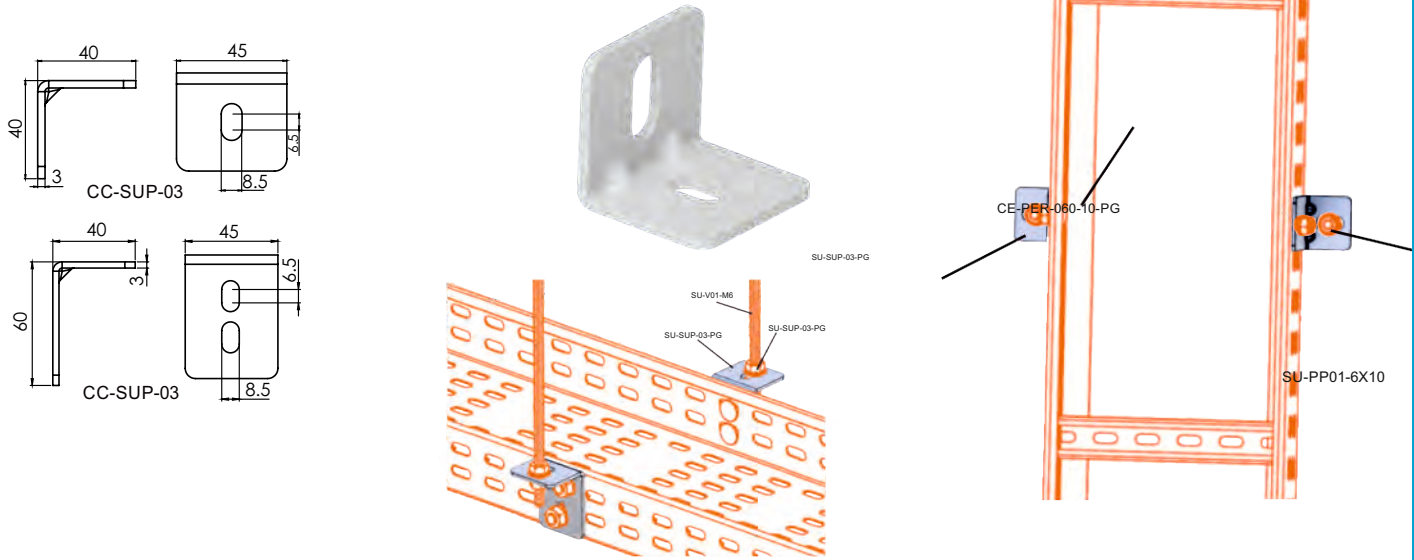

Código	mm	mm	kg/mt	mm	Acabamento	P.U. €
SU-SUP-03-PG	45mm	40mm	0,075g	3,0mm	Sendzimir	5,60€
SU-SUP-03-HDG	45mm	40mm	0,075g	3,0mm	Galvanizado Quente	7,55€

- Artigo de stock habitual
- Artigo disponível por encomenda

Clip para Tampa p/Caminho Cabos

Acabamento: Sendzimir - EN 10346

Acabamento: Galvanizado a Quente - EN 61537



mm	mm	mm	kg	Código(Galvanizado Quente)	P.U. €	Código(Sendzimir)	P.U. €
20mm	40mm	2,0mm	0,028kg	CC-CLIP01-040-HDG	1,15€	CC-CLIP01-040-PG	0,85€
20mm	50mm	2,0mm	0,030kg	CC-CLIP01-050-HDG	1,30€	CC-CLIP01-050-PG	0,95€
20mm	60mm	2,0mm	0,032kg	CC-CLIP01-060-HDG	1,45€	CC-CLIP01-060-PG	1,05€
20mm	100mm	2,0mm	0,050kg	CC-CLIP01-100-HDG	1,65€	CC-CLIP01-100-PG	1,20€

- Artigo de stock habitual
- Artigo disponível por encomenda

Perfil de Borracha para Protecção Calhas



Código	Descrição	P.U. €
CC-PER-BOR-01	Perfil de Borracha para protecção Calha Metálica (Rolo com 100mts)	260,00€
CC-PER-BOR-02	Perfil de Borracha para protecção Calha Metálica (Rolo com 5mts)	35,00€

- Artigo de stock habitual
- Artigo disponível por encomenda

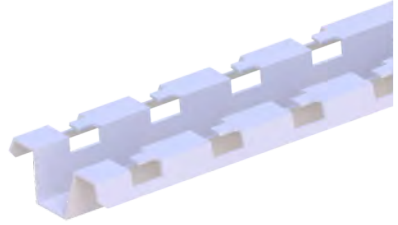

Perfil Omega de Fixação Rápida

mm	mm	mm	mm	kg/mt	Código(Galvanizado Quente)	P.U./mt €		Código(Sendzimir)	P.U./mt €	
2000	75	1,5	2000	1,100	SU-POFR-HDG	38,00	●	SU-POFR-PG	28,00	●

Perfil em C

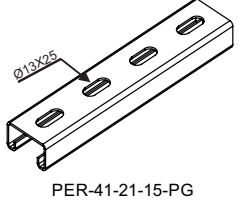
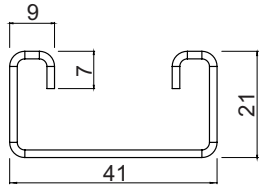

PER-41-21-15-PG



mm	mm	mm	mm	kg/mt	Código(Galvanizado Quente)	P.U./mt €		Código(Sendzimir)	P.U./mt €	
41	21	1,5	3000	1,100	SU-P41-21-15-HDG	13,10	●	SU-P41-21-15-PG	9,65	●
41	21	2,0	3000	1,465	SU-P41-21-20-HDG	16,15	●	SU-P41-21-20-PG	12,70	●

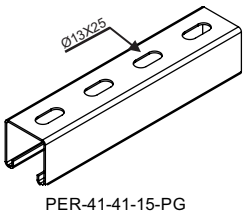
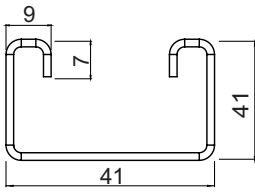

PER-41-41-15-PG

- Artigo de stock habitual
- Artigo disponível por encomenda

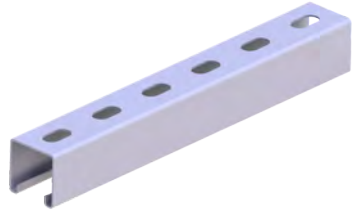

mm	mm	mm	mm	kg/mt	Código(Galvanizado Quente)	P.U./mt €		Código(Sendzimir)	P.U./mt €	
41	41	1,5	3000	1,420	SU-P41-41-15-HDG	22,20	●	SU-P41-41-15-PG	16,45	●
41	41	2,0	3000	1,895	SU-P41-41-20-HDG	24,85	●	SU-P41-41-20-PG	19,40	●

- Artigo de stock habitual
- Artigo disponível por encomenda

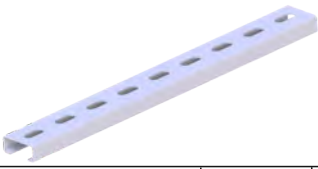
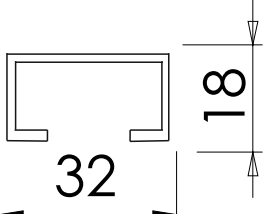

mm	mm	mm	mm	kg/mt	Código	Acabamento	P.U./mt €	
32	18	1,2	3000	1,420	SU-P32-18-12-PG	Sendzimir	3,75	●
32	18	1,2	3000	1,695	SU-P32-18-12-HDG	Galvanizado Quente	5,10	●
32	18	1,2	3000	1,895	SU-P32-18-12-SS304	Inox 304	26,35	●

- Artigo de stock habitual
- Artigo disponível por encomenda

Perfil em U

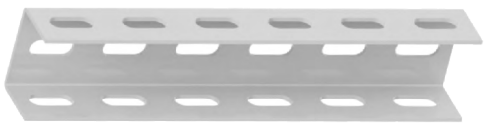
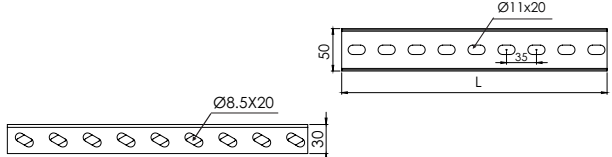
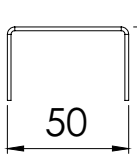

mm	mm	mm	mm	kg/mt	Código(Galvanizado Quente)	P.U./mt €		Código(Sendzimir)	P.U./mt €	
50	30	3000	1,5	1,090	SU-P-U50-30-15-HDG	24,25	●	SU-P-U50-30-15-PG	17,95	●

- Artigo de stock habitual
- Artigo disponível por encomenda

Suporte para Perfil C 41... Galvanizado a Quente

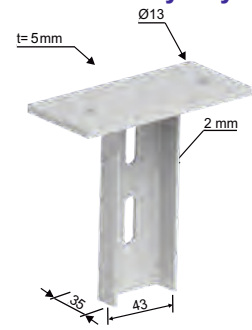
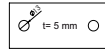
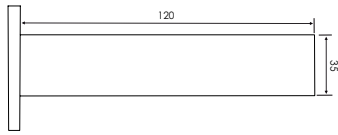

Código	mm	kg	mm	Acabamento	P.U. €
SU-BASE-PER-C-HDG	41mm	0,955kg	2,0mm	Galvanizado a Quente	7,50€

Base para Perfil U

Taban Delik Detay
Base hole detail

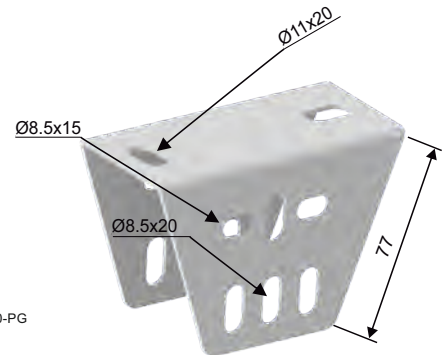
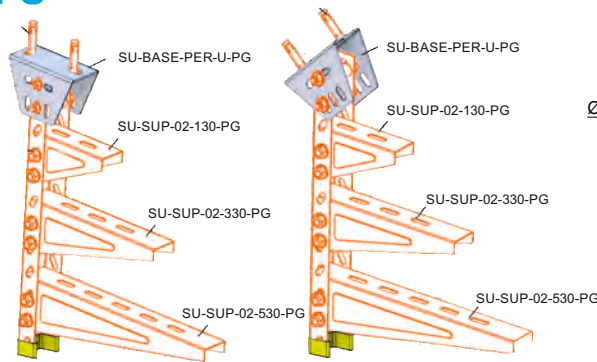
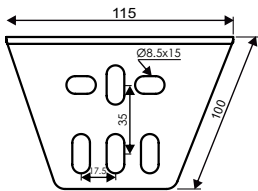
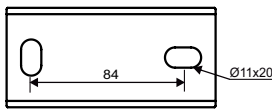

mm	mm	mm	kg	Código(Galvanizado Quente)	P.U. €	Código(Sendzimir)	P.U. €
115mm	100mm	2,0mm	0,270kg/mt	SU-BASE-PER-U-HDG	8,95€	SU-BASE-PER-U-PG	6,60€

- Artigo de stock habitual
- Artigo disponível por encomenda

Suporte para Perfil U

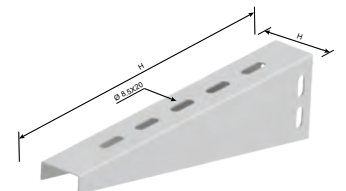
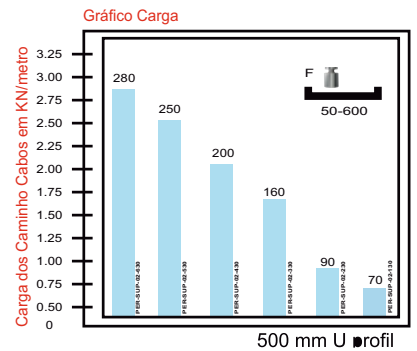
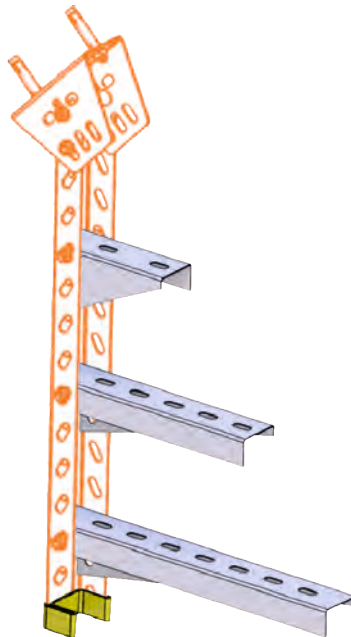
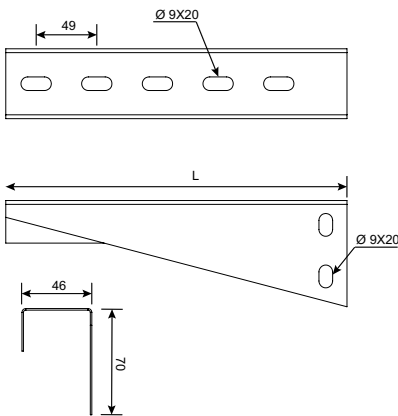

mm	mm	mm	mm	kg	Código(Galvanizado Quente)	P.U. €	Código(Sendzimir)	P.U. €
130mm	80mm	46mm	1,5mm	0,115kg	SU-SUP-02-130-HDG	7,80€	SU-SUP-02-130-PG	5,75€
230mm	80mm	46mm	1,5mm	0,205kg	SU-SUP-02-230-HDG	9,25€	SU-SUP-02-230-PG	6,85€
330mm	80mm	46mm	1,5mm	0,325kg	SU-SUP-02-330-HDG	13,10€	SU-SUP-02-330-PG	9,70€
430mm	80mm	46mm	2,0mm	0,460kg	SU-SUP-02-430-HDG	15,10€	SU-SUP-02-430-PG	11,15€
530mm	80mm	46mm	2,0mm	1,140kg	SU-SUP-02-530-HDG	20,55€	SU-SUP-02-530-PG	15,20€
630mm	80mm	46mm	2,0mm	1,335kg	SU-SUP-02-630-HDG	23,35€	SU-SUP-02-630-PG	17,30€

- Artigo de stock habitual
- Artigo disponível por encomenda

Suporte para Perfil C 41X21 Galvanizado a Quente

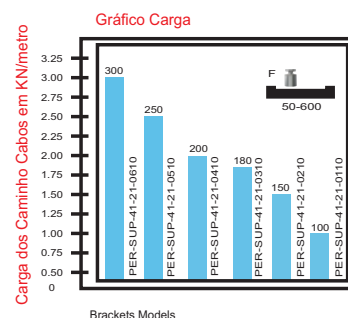
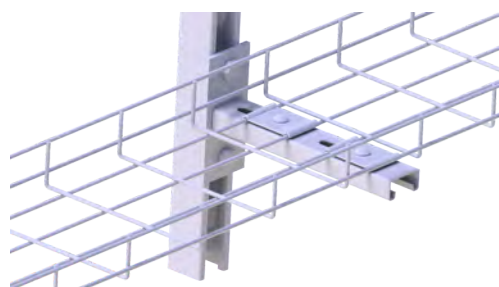
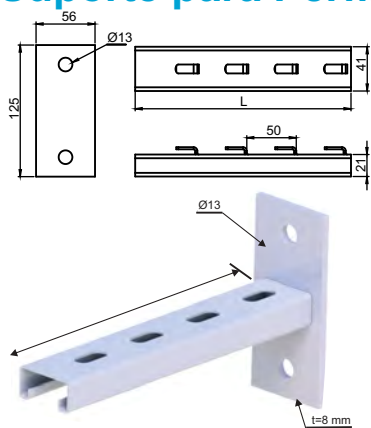

Código	mm	mm	mm	kg	mm	Acabamento	P.U. €	
SU-SUP4121-0410HDG	410mm	121mm	45mm	0,955kg	2,0mm	Galvanizado a Quente	13,15€	●
SU-SUP4121-0610HDG	610mm	121mm	45mm	1,275kg	2,0mm	Galvanizado a Quente	15,65€	●

- Artigo de stock habitual
- Artigo disponível por encomenda

Suporte para Perfil C 41X41 Galvanizado a Quente

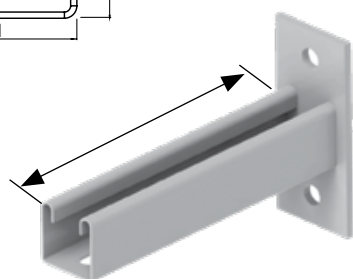
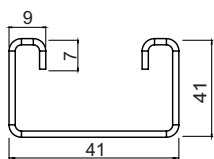

CC-SUP-41-41-0410

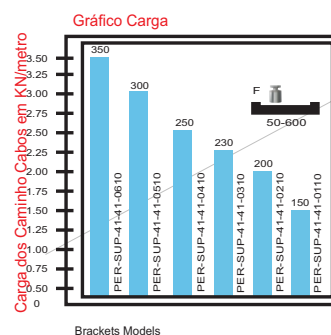

Código	mm	mm	mm	kg	mm	Acabamento	P.U. €	
SU-SUP4141-0410HDG	410mm	121mm	45mm	1,240kg	2,0mm	Galvanizado a Quente	20,10€	●
SU-SUP4141-0610HDG	610mm	121mm	45mm	1,700kg	2,0mm	Galvanizado a Quente	25,65€	●
SU-SUP4141-1500HDG	1500mm	121mm	45mm	3,500kg	2,0mm	Galvanizado a Quente	48,40€	●

- Artigo de stock habitual
- Artigo disponível por encomenda

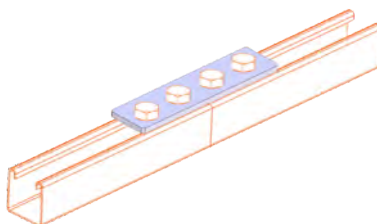
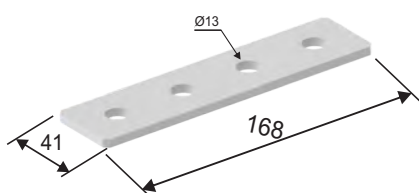

União para Perfil C 41... Galvanizado a Quente

Código	mm	mm	mm	kg	mm	Acabamento	P.U. €	
SU-UNI-P41-HDG	125mm	5mm	42mm	0,200kg	2,0mm	Galvanizado a Quente	5,80€	●

- Artigo de stock habitual
- Artigo disponível por encomenda



Pafafusos

Código	Descrição	Métrica	Cumprimento	Acabamento	P.U. €	
SU-PP01-6X10-PG	Parafuso + Porca	M6	10mm	Galvanizado	21,05€/cento	●
SU-PP01-6X10-HDG	Parafuso + Porca	M6	10mm	Galvanizado a Quente	45,00€/cento	●
SU-PP01-8X15-PG	Parafuso + Porca	M8	15mm	Galvanizado	28,50€/cento	●
SU-POR-SEX-M6	Porca M6	M6		Galvanizado	7,50€/cento	●
SU-POR-SEX-M8	Porca M8	M8		Galvanizado	8,50€/cento	●
SU-ANI-AL-M6	Anilha M6	M6		Galvanizado	12,00€/cento	●
SU-ANI-AL-M8	Anilha M8	M8		Galvanizado	13,00€/cento	●

- Artigo de stock habitual
- Artigo disponível por encomenda

Varão Roscado



Descrição	Métrica	Acabamento	Código	mm	P.U. €		Código	mm	P.U. €	
Varão Roscado	M6	Galvanizado	SU-V01-M6	1000mm	1,85€	●	SU-V02-M6	2000mm	3,70€	●
Varão Roscado	M8	Galvanizado	SU-V01-M8	1000mm	2,75€	●	SU-V02-M8	2000mm	5,50€	●
Varão Roscado	M10	Galvanizado	SU-V01-M10	1000mm	3,15€	●	SU-V02-M10	2000mm	6,30€	●
Varão Roscado	M12	Galvanizado	SU-V01-M12	1000mm	4,20€	●	SU-V02-M12	2000mm	8,40€	●

- Artigo de stock habitual
- Artigo disponível por encomenda

União para Varão Roscado



Código	Métrica	Descrição	Acabamento	P.U. €	
SU-UV01-M6	M6	Varão Roscado	Galvanizado	0,95€	●
SU-UV01-M8	M8	Varão Roscado	Galvanizado	1,35€	●
SU-UV01-M10	M10	Varão Roscado	Galvanizado	1,75€	●
SU-UV01-M12	M12	Varão Roscado	Galvanizado	2,25€	●

Clip para Viga



Código	mm	Ø	Cor	P.U. €
SU-CLIP116	1-4mm	15-18mm	Preto	0,50€
SU-CLIP120	4-7,5mm	15-18mm	Preto	0,50€
SU-CLIP125	7,5-12mm	15-18mm	Preto	0,50€
SU-CLIP416	1-4mm	19-24mm	Preto	0,60€
SU-CLIP420	4-7,5mm	19-24mm	Preto	0,60€
SU-CLIP425	7,5-12mm	25-30mm	Preto	0,60€
SU-CLIP716	1-4mm	16	Preto	0,70€
SU-CLIP720	4-7,5mm	20	Preto	0,70€
SU-CLIP725	7,5-12mm	25	Preto	0,70€

Clip para Viga

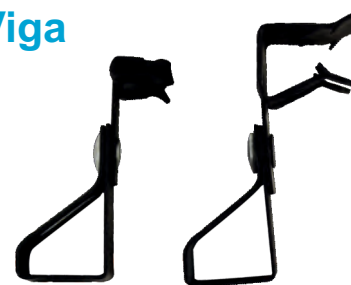

Código	mm	Furo	Cor	P.U. €
SU-CLIP04M6	1,5-4mm	M6	Preto	1,30€
SU-CLIP10M6	4-10mm	M6	Preto	1,30€
SU-CLIP15M6	10-15mm	M6	Preto	1,30€
SU-CLIP20M6	15-20mm	M6	Preto	1,30€
SU-CLIP04M8	1,5-4mm	M8	Preto	1,30€
SU-CLIP10M8	4-10mm	M8	Preto	1,30€
SU-CLIP15M8	10-15mm	M8	Preto	1,30€
SU-CLIP20M8	15-20mm	M8	Preto	1,30€

Abraçadeiras para Tubo VD FIX-RING



Código	Descrição	P.U. /Cento€	
SU-FIX-RING-116	Abraçadeira FIX-RING Simples para Tubo VD 16	46,00€/cento	●
SU-FIX-RING-120	Abraçadeira FIX-RING Simples para Tubo VD 20	46,40€/cento	●
SU-FIX-RING-125	Abraçadeira FIX-RING Simples para Tubo VD 25	49,20€/cento	●
SU-FIX-RING-132	Abraçadeira FIX-RING Simples para Tubo VD 32	75,30€/cento	●
SU-FIX-RING-216	Abraçadeira FIX-RING Dupla para Tubo VD 16	57,00€/cento	●
SU-FIX-RING-220	Abraçadeira FIX-RING Dupla para Tubo VD 20	58,00€/cento	●
SU-FIX-RING-225	Abraçadeira FIX-RING Dupla para Tubo VD 25	68,00€/cento	●
SU-FIX-RING-420	Abraçadeira FIX-RING Quadrupla para Tubo VD 20	96,50€/cento	●
SU-FIX-RING-425	Abraçadeira FIX-RING Quadrupla para Tubo VD 25	118,60€/cento	●

- Artigo de stock habitual
- Artigo disponível por encomenda



Buchas de Latão

Código	Descrição	P.U. €/Cento	
SU-BUCHA-LT6	Bucha Latão 6mm	16,60€/Cento	●
SU-BUCHA-LT8	Bucha Latão 8mm	47,00€/Cento	●
SU-BUCHA-LT10	Bucha Latão 10mm	84,50€/Cento	●
SU-BUCHA-LT10	Bucha Latão 10mm	189,00€/Cento	●



Spray de Zinco

Código	Descrição	P.U. €	
SU-SPRAY-ZINCO	Spray de Zinco Brilhante	15,00€	●

Porca Guia



Código	Métrica	Perfil	P.U. €
SU-PG-M06	M6	P/Perfil 41x21	0,85€
SU-PG-M08	M8	P/Perfil 41x41	0,95€
SU-PG-M10	M10	P/Perfil 41x41	1,25€
SU-PG-M12	M12	P/Perfil 41x41	1,85€

Mordçaça para Varão Roscado

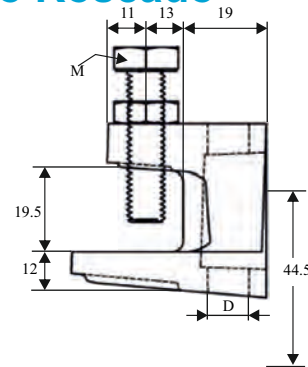

Código	Métrica	Espessura	P.U. €
SU-MO-M08	M8	0-22mm	4,65€
SU-MO-M10	M10	0-19mm	5,70€
SU-MO-M12	M12	5-25mm	6,10€

Fixação do Perfil á Viga



Código	Descrição	P.U. €
SU-FIX-PERFIL-01	Abraçadeira Fixação Perfil	7,50€

Fita D'Aço



Código	Rolo	Furo	Dimensões	P.U./ €
SU-FAP12	10mts	5mm	12x0,8mm	8,55€/Rolo
SU-FAP17	10mts	7mm	17x0,8mm	10,70€/Rolo

Topo para Perfil



Código	Descrição	Embal.	P.U. €
SU-TOPO-3218	Topo para Perfil 32x18	100unid.	0,90€
SU-TOPO-4121	Topo para Perfil 41x21	100unid.	1,28€
SU-TOPO-4141	Topo para Perfil 41x41	100unid.	1,28€

Caixa de Chão

Código	Descrição	P.U. €
SL-CX-CC01	Caixa (Negativo) para Caixa Pavimento	41,85€
SL-ARO-CC01	Aro para Caixa Pavimento	31,50€
SL-TP-CC01	Tampa p/Proteção Cimento p/cx. Chão	16,15€

c) Tampa para proteção da caixa quando chumbada no piso (evita entrada de lixo)

b)

Aro para Caixa Pavimento com Tampa

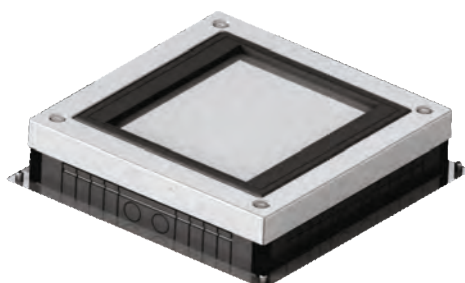

a)

Caixa (Negativo) para Caixa Pavimento, apenas a Caixa

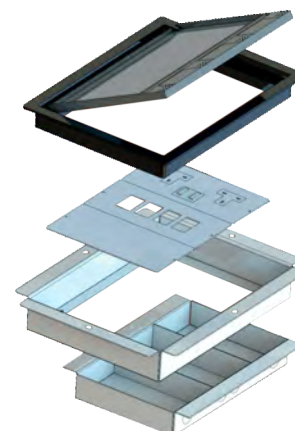
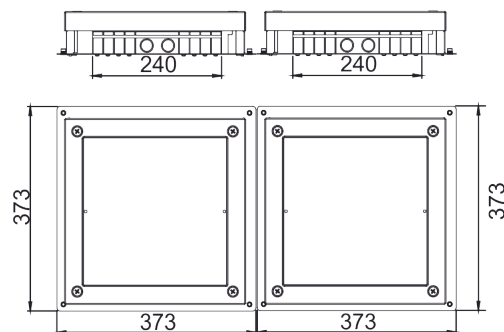

Disjuntores Magnetotérmicos

Disjuntores Automáticos Magnetotérmicos 4,5 kA (4500A)-Curva C (IEC 60898)

Gama Doméstica



Código	Pol.	Int.(A)	Emb.	P.U.€
SL-CP01106	1P	6A	12/180	1,90€
SL-CP01110	1P	10A	12/180	1,90€
SL-CP01116	1P	16A	12/180	1,90€
SL-CP01120	1P	20A	12/180	1,90€
SL-CP01125	1P	25A	12/180	1,90€
SL-CP01132	1P	32A	12/180	1,90€



Código	Pol.	Int.(A)	Emb.	P.U.€
SL-CP01506	F+N	6A	12/180	5,50€
SL-CP01510	F+N	10A	12/180	5,50€
SL-CP01516	F+N	16A	12/180	5,50€
SL-CP01520	F+N	20A	12/180	5,50€
SL-CP01525	F+N	25A	12/180	5,50€
SL-CP01532	F+N	32A	12/180	5,50€

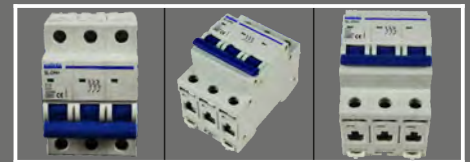

Código	Pol.	Int.(A)	Emb.	P.U.€
SL-CP01306	3P	6A	4/60	8,70€
SL-CP01310	3P	10A	4/60	8,70€
SL-CP01316	3P	16A	4/60	8,70€
SL-CP01320	3P	20A	4/60	8,70€
SL-CP01325	3P	25A	4/60	8,70€
SL-CP01332	3P	32A	4/60	8,70€

Disjuntores Automáticos Magnetotérmicos 6 kA (6000A)-Curva C (IEC 60898)

Gama Terciária



Código	Pol.	Int.(A)	Emb.	P.U.€
SL-CP02101	1P	1A	12/180	3,25€
SL-CP02102	1P	2A	12/180	3,25€
SL-CP02103	1P	3A	12/180	3,25€
SL-CP02104	1P	4A	12/180	3,25€
SL-CP02106	1P	6A	12/180	2,30€
SL-CP02110	1P	10A	12/180	2,30€
SL-CP02116	1P	16A	12/180	2,30€
SL-CP02120	1P	20A	12/180	2,30€
SL-CP02125	1P	25A	12/180	2,30€
SL-CP02132	1P	32A	12/180	2,30€
SL-CP02140	1P	40A	12/180	3,25€
SL-CP02150	1P	50A	12/180	3,25€
SL-CP02163	1P	63A	12/180	3,25€



Código	Pol.	Int.(A)	Emb.	P.U.€
SL-CP02301	3P	1A	4/60	11,80€
SL-CP02302	3P	2A	4/60	11,80€
SL-CP02303	3P	3A	4/60	11,80€
SL-CP02304	3P	4A	4/60	11,80€
SL-CP02306	3P	6A	4/60	9,80€
SL-CP02310	3P	10A	4/60	9,80€
SL-CP02316	3P	16A	4/60	9,80€
SL-CP02320	3P	20A	4/60	9,80€
SL-CP02325	3P	25A	4/60	9,80€
SL-CP02332	3P	32A	4/60	9,80€
SL-CP02340	3P	40A	4/60	11,80€
SL-CP02350	3P	50A	4/60	11,80€
SL-CP02363	3P	63A	4/60	11,80€



Código	Pol.	Int.(A)	Emb.	P.U.€
SL-CP02401	4P	1A	3/30	19,30€
SL-CP02402	4P	2A	3/30	19,30€
SL-CP02403	4P	3A	3/30	19,30€
SL-CP02404	4P	4A	3/30	19,30€
SL-CP02406	4P	6A	3/30	16,00€
SL-CP02410	4P	10A	3/30	16,00€
SL-CP02416	4P	16A	3/30	16,00€
SL-CP02420	4P	20A	3/30	16,00€
SL-CP02425	4P	25A	3/30	16,00€
SL-CP02432	4P	32A	3/30	16,00€
SL-CP02440	4P	40A	3/30	19,30€
SL-CP02450	4P	50A	3/30	19,30€
SL-CP02463	4P	63A	3/30	19,30€



Código	Pol.	Int.(A)	Emb.	P.U.€
SL-CP02501	F+N	6A	12/180	12,00€
SL-CP02502	F+N	10A	12/180	12,00€
SL-CP02504	F+N	16A	12/180	12,00€
SL-CP02506	F+N	6A	12/180	8,90€
SL-CP02510	F+N	10A	12/180	8,90€
SL-CP02516	F+N	16A	12/180	8,90€
SL-CP02520	F+N	20A	12/180	8,90€
SL-CP02525	F+N	25A	12/180	8,90€
SL-CP02532	F+N	32A	12/180	8,90€

Novos Podutos

Acessórios para Disjuntores 6KA

Bobine Emissão Corrente
Disparo por um Impulso de Tensão
Largura 18mm



Código	Int.(A)	Emb.	P.U.€
SL-CP02-BD02-MX	1A	3/30	39,50€

Bobine de Mínima Tensão
Disparo por Dimin.ou Queda Tensão
Largura 18mm

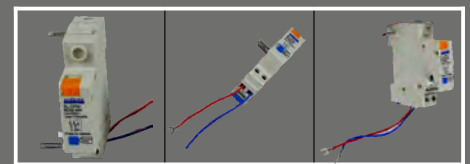

Código	Int.(A)	Emb.	P.U.€
SL-CP02-BD02-MN	1A	3/30	39,50€

Contacto Auxiliar 1NO+1NC

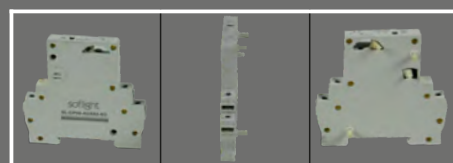

Código	Int.(A)	Emb.	P.U.€
SL-CP02-AUX02-SD	1A	3/30	20,00€

Disjuntores Magnet. Curva B e D

soflight®

Electric

Disjuntores Automáticos Magnetotérmicos 6 kA (6000A)-Curva B

Gama Terciária

(IEC 60898)

Novos
Podutos



Código	Pol.	Int.(A)	Emb.	P.U.€
SL-CP02106-B	1P	6A	12/180	3,25€
SL-CP02110-B	1P	10A	12/180	3,25€
SL-CP02116-B	1P	16A	12/180	3,25€
SL-CP02120-B	1P	20A	12/180	3,25€
SL-CP02125-B	1P	25A	12/180	3,25€
SL-CP02132-B	1P	32A	12/180	3,25€
SL-CP02140-B	1P	40A	12/180	3,50€
SL-CP02150-B	1P	50A	12/180	3,50€
SL-CP02163-B	1P	63A	12/180	3,50€

Código	Pol.	Int.(A)	Emb.	P.U.€
SL-CP02206-B	2P	6A	6/90	8,60€
SL-CP02210-B	2P	10A	6/90	8,60€
SL-CP02216-B	2P	16A	6/90	8,60€
SL-CP02220-B	2P	20A	6/90	8,60€
SL-CP02225-B	2P	25A	6/90	8,60€
SL-CP02232-B	2P	32A	6/90	8,60€
SL-CP02240-B	2P	40A	6/90	9,50€
SL-CP02250-B	2P	50A	6/90	9,50€
SL-CP02263-B	2P	63A	6/90	9,50€

Código	Pol.	Int.(A)	Emb.	P.U.€
SL-CP02306-B	3P	6A	4/60	12,00€
SL-CP02310-B	3P	10A	4/60	12,00€
SL-CP02316-B	3P	16A	4/60	12,00€
SL-CP02320-B	3P	20A	4/60	12,00€
SL-CP02325-B	3P	25A	4/60	12,00€
SL-CP02332-B	3P	32A	4/60	12,00€
SL-CP02340-B	3P	40A	4/60	14,00€
SL-CP02350-B	3P	50A	4/60	14,00€
SL-CP02363-B	3P	63A	4/60	14,00€



Código	Pol.	Int.(A)	Emb.	P.U.€
SL-CP02406-B	4P	6A	3/30	22,00€
SL-CP02410-B	4P	10A	3/30	22,00€
SL-CP02416-B	4P	16A	3/30	22,00€
SL-CP02420-B	4P	20A	3/30	22,00€
SL-CP02425-B	4P	25A	3/30	22,00€
SL-CP02432-B	4P	32A	3/30	22,00€
SL-CP02440-B	4P	40A	3/30	25,00€
SL-CP02450-B	4P	50A	3/30	25,00€
SL-CP02463-B	4P	63A	3/30	25,00€



Código	Pol.	Int.(A)	Emb.	P.U.€
SL-CP02506-B	F+N	6A	12/180	14,00€
SL-CP02510-B	F+N	10A	12/180	14,00€
SL-CP02516-B	F+N	16A	12/180	14,00€
SL-CP02520-B	F+N	20A	12/180	14,00€
SL-CP02525-B	F+N	25A	12/180	14,00€
SL-CP02532-B	F+N	32A	12/180	14,00€

Novos
Podutos

Disjuntores Automáticos Magnetotérmicos 6 kA (6000A)-Curva D

Gama Terciária

(IEC 60898)



Código	Pol.	Int.(A)	Emb.	P.U.€
SL-CP02106-D	1P	6A	12/180	3,25€
SL-CP02110-D	1P	10A	12/180	3,25€
SL-CP02116-D	1P	16A	12/180	3,25€
SL-CP02120-D	1P	20A	12/180	3,25€
SL-CP02125-D	1P	25A	12/180	3,25€
SL-CP02132-D	1P	32A	12/180	3,25€
SL-CP02140-D	1P	40A	12/180	3,50€
SL-CP02150-D	1P	50A	12/180	3,50€
SL-CP02163-D	1P	63A	12/180	3,50€

Código	Pol.	Int.(A)	Emb.	P.U.€
SL-CP02206-D	2P	6A	6/90	8,60€
SL-CP02210-D	2P	10A	6/90	8,60€
SL-CP02216-D	2P	16A	6/90	8,60€
SL-CP02220-D	2P	20A	6/90	8,60€
SL-CP02225-D	2P	25A	6/90	8,60€
SL-CP02232-D	2P	32A	6/90	8,60€
SL-CP02240-D	2P	40A	6/90	9,50€
SL-CP02250-D	2P	50A	6/90	9,50€
SL-CP02263-D	2P	63A	6/90	9,50€

Código	Pol.	Int.(A)	Emb.	P.U.€
SL-CP02306-D	3P	6A	4/60	12,00€
SL-CP02310-D	3P	10A	4/60	12,00€
SL-CP02316-D	3P	16A	4/60	12,00€
SL-CP02320-D	3P	20A	4/60	12,00€
SL-CP02325-D	3P	25A	4/60	12,00€
SL-CP02332-D	3P	32A	4/60	12,00€
SL-CP02340-D	3P	40A	4/60	14,00€
SL-CP02350-D	3P	50A	4/60	14,00€
SL-CP02363-D	3P	63A	4/60	14,00€



Código	Pol.	Int.(A)	Emb.	P.U.€
SL-CP02406-D	4P	6A	3/30	22,00€
SL-CP02410-D	4P	10A	3/30	22,00€
SL-CP02416-D	4P	16A	3/30	22,00€
SL-CP02420-D	4P	20A	3/30	22,00€
SL-CP02425-D	4P	25A	3/30	22,00€
SL-CP02432-D	4P	32A	3/30	22,00€
SL-CP02440-D	4P	40A	3/30	25,00€
SL-CP02450-D	4P	50A	3/30	25,00€
SL-CP02463-D	4P	63A	3/30	25,00€



Código	Pol.	Int.(A)	Emb.	P.U.€
SL-CP02506-D	F+N	6A	12/180	14,00€
SL-CP02510-D	F+N	10A	12/180	14,00€
SL-CP02516-D	F+N	16A	12/180	14,00€
SL-CP02520-D	F+N	20A	12/180	14,00€
SL-CP02525-D	F+N	25A	12/180	14,00€
SL-CP02532-D	F+N	32A	12/180	14,00€

Disjuntores Magnetotérmicos

Disjuntores Automáticos Magnetotérmicos 10 kA(10000A)-Curva C (IEC 60947-2)



Código	Pol.	Int.(A)	Emb.	P.U.€
SL-CP03106	1P	6A	12/180	7,05€
SL-CP03110	1P	10A	12/180	7,05€
SL-CP03116	1P	16A	12/180	7,05€
SL-CP03120	1P	20A	12/180	7,05€
SL-CP03125	1P	25A	12/180	7,05€
SL-CP03132	1P	32A	12/180	7,05€
SL-CP03140	1P	40A	12/180	8,20€
SL-CP03150	1P	50A	12/180	8,20€
SL-CP03163	1P	63A	12/180	8,20€



Código	Pol.	Int.(A)	Emb.	P.U.€
SL-CP03206	2P	6A	6/90	17,40€
SL-CP03210	2P	10A	6/90	17,40€
SL-CP03216	2P	16A	6/90	17,40€
SL-CP03220	2P	20A	6/90	17,40€
SL-CP03225	2P	25A	6/90	17,40€
SL-CP03232	2P	32A	6/90	17,40€
SL-CP03240	2P	40A	6/90	19,00€
SL-CP03250	2P	50A	6/90	19,00€
SL-CP03263	2P	63A	6/90	19,00€



Código	Pol.	Int.(A)	Emb.	P.U.€
SL-CP03306	3P	6A	4/60	24,50€
SL-CP03310	3P	10A	4/60	24,50€
SL-CP03316	3P	16A	4/60	24,50€
SL-CP03320	3P	20A	4/60	24,50€
SL-CP03325	3P	25A	4/60	24,50€
SL-CP03332	3P	32A	4/60	24,50€
SL-CP03340	3P	40A	4/60	27,50€
SL-CP03350	3P	50A	4/60	27,50€
SL-CP03363	3P	63A	4/60	27,50€



Código	Pol.	Int.(A)	Emb.	P.U.€
SL-CP03406	4P	6A	3/45	33,00€
SL-CP03410	4P	10A	3/45	33,00€
SL-CP03416	4P	16A	3/45	33,00€
SL-CP03420	4P	20A	3/45	33,00€
SL-CP03425	4P	25A	3/45	33,00€
SL-CP03432	4P	32A	3/45	33,00€
SL-CP03440	4P	40A	3/45	35,00€
SL-CP03450	4P	50A	3/45	35,00€
SL-CP03463	4P	63A	3/45	35,00€



Código	Pol.	Int.(A)	Emb.	P.U.€
SL-CP03180	1P	80A	12/180	13,00€
SL-CP031100	1P	100A	12/180	13,00€
SL-CP031125	1P	125A	12/180	13,00€



Código	Pol.	Int.(A)	Emb.	P.U.€
SL-CP03280	2P	80A	6/90	25,00€
SL-CP032100	2P	100A	6/90	25,00€
SL-CP032125	2P	125A	6/90	25,00€

Acessórios para Disjuntores 10KA até 63A

Bobine Emissão Corrente
Disparo por um Impulso de Tensão
Largura 18mm

Bobine de Mínima Tensão
Disparo p/ Dimin.ou Queda Tensão
Largura 18mm



Código	Pol.	Int.(A)	Emb.	P.U.€
SL-CP03380	3P	80A	4/60	36,50€
SL-CP033100	3P	100A	4/60	37,10€
SL-CP033125	3P	125A	4/60	40,20€



Código	Pol.	Int.(A)	Emb.	P.U.€
SL-CP03-AUX03-MX 1A	1A		3/30	41,90€



Código	Pol.	Int.(A)	Emb.	P.U.€
SL-CP03-AUX03-MN 1A	1A		3/30	41,90€

Contacto Auxiliar 1NO-1NC

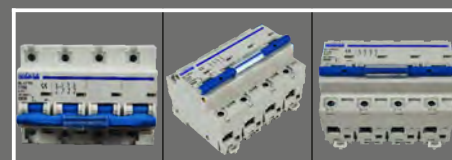

Código	Pol.	Int.(A)	Emb.	P.U.€
SL-CP03480	4P	80A	3/45	44,70€
SL-CP034100	4P	100A	3/45	48,95€
SL-CP034125	4P	125A	3/45	54,50€

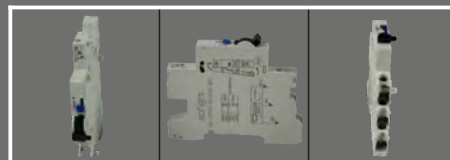

Código	Pol.	Int.(A)	Emb.	P.U.€
SL-CP03-BD03-SD 1A	1A		3/30	20,30€

Acessórios para Disjuntores 10KA (80 a 125A)

Bobine Emissão Corrente
Disparo por Impulso de Tensão
Largura 18mm

Bobine de Mínima Tensão
Disparo por Dimin./Queda Tensão
Largura 18mm

Contato Auxiliar 1NO+1NC



Código	Int.(A)	Emb.	P.U.€
SL-CP02-BD02-MX 1A	1A	3/30	39,50€

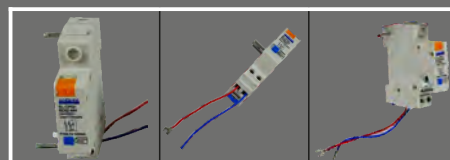

Código	Int.(A)	Emb.	P.U.€
SL-CP02-BD02-MN 1A	1A	3/30	39,50€

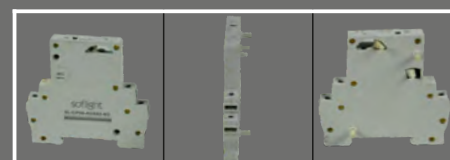

Código	Int.(A)	Emb.	P.U.€
SL-CP02-AUX02-SD 1A	1A	3/30	20,00€

Acessórios para Fotovoltaicos

Novos
Produtos

soflight®

Electric

Gama Industrial

Disjuntores Automáticos Magnetotérmicos 6 kA(6000A)-500Vdc

(IEC 60947-2)



Código	Pol.	Int.(A)	Emb.	P.U.€
SL-CP02210-DC	2P	10A	6/90	12,50€
SL-CP02216-DC	2P	16A	6/90	12,50€
SL-CP02220-DC	2P	20A	6/90	12,50€
SL-CP02225-DC	2P	25A	6/90	12,50€
SL-CP02232-DC	2P	32A	6/90	12,50€

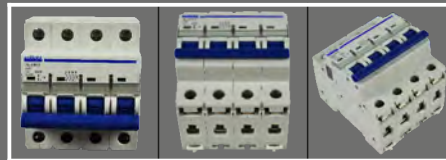

Código	Pol.	Int.(A)	Emb.	P.U.€
SL-CP02410-DC	4P	10A	6/90	25,00€
SL-CP02416-DC	4P	16A	6/90	25,00€
SL-CP02420-DC	4P	20A	6/90	25,00€
SL-CP02425-DC	4P	25A	6/90	25,00€
SL-CP02432-DC	4P	32A	6/90	25,00€

Fusíveis Cilíndricos em DC (IEC60269)

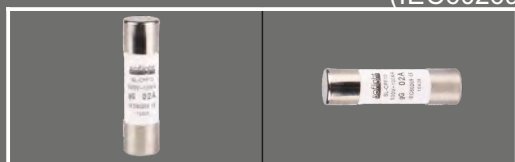

Código	Fusível	Int.(A)	Emb.	P.U.€
SL-CP10X38-02A-DC	10x38	2A	10un.	3,65€
SL-CP10X38-04A-DC	10x38	4A	10un.	3,65€
SL-CP10X38-06A-DC	10x38	6A	10un.	3,65€
SL-CP10X38-08A-DC	10x38	8A	10un.	3,65€
SL-CP10X38-10A-DC	10x38	10A	10un.	3,65€
SL-CP10X38-16A-DC	10x38	16A	10un.	3,65€
SL-CP10X38-20A-DC	10x38	20A	10un.	3,65€
SL-CP10X38-25A-DC	10x38	25A	10un.	3,65€
SL-CP10X38-32A-DC	10x38	32A	10un.	3,65€

Bases Porta-Fusíveis em DC



Código	Descrição	Nº Pol.	Tipo Fusível	Emb.	P.U.€
SL-CP07101-DC	Base Porta- Fusível 1P	10x38	12/192	3,35€	

Limitador Sobre tensão em DC (IEC61643.1)

Gama Terciária e Industrial

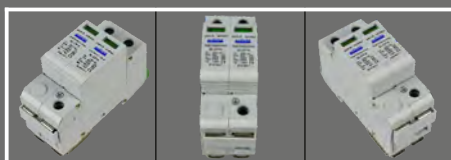

* Tipo: 2
* Numero Polos:2
* Voltagem Max.: 500/600Vdc
* Corrente:
Mínima Descarga: 20kA
Máxima Descarga: 40kA
* Nivel Protecção Tensão 1,8kV
* Temper. Trabalho: -40 a 80°C

Código	Numero Modulos	Descrição	P.U.€
SL-CP14240KA-DC	2P	20-40KA 500/600Vdc T2	55,00€

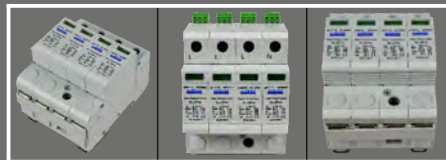

* Tipo: 2
* Numero Polos: 3
* Voltagem Max.: 1000Vdc
* Corrente:
Mínima Descarga: 20kA
Máxima Descarga: 40kA
* Nivel Protecção Tensão 1,8kV
* Temper. Trabalho: -40 a 80°C

Código	Numero Modulos	Descrição	P.U.€
SL-CP14340KA-DC	3P	20-40KA 1000Vdc T2	102,00€



Código	Descrição	P.U.€
SL-CP-MC4-M	Ficha Macho Simples	1,25€
SL-CP-MC4-Y2-M	Ficha Macho Simples em Y	4,75€
SL-CP-MC4-T2-M	Ficha Macho Dupla em T	4,75€
SL-CP-MC4-T3-M	Ficha Macho Tripla em T	8,00€
SL-CP-MV4-T4-M	Ficha Macho Quadrupla em T	10,00€



Código	Descrição	P.U.€
SL-CP-MC4-F	Ficha Fêmea Simples	1,25€
SL-CP-MC4-Y2-F	Ficha Fêmea Simples em Y	4,75€
SL-CP-MC4-T2-F	Ficha Fêmea Dupla em T	4,75€
SL-CP-MC4-T3-F	Ficha Fêmea Tripla em T	8,00€
SL-CP-MV4-T4-F	Ficha Fêmea Quadrupla em T	10,00€

Inversor 32A 1000Vdc



Código	Numero Modulos	Descrição	P.U.€
SL-CP-63-432-DC	4P	Inversor 32A 1000Vdc IP65	80,00€

Disjuntores Caixa Moldada

Disjuntor em Caixa Moldada Electromecânicos (IEC 60947-2)

Gama Terciária e Industrial



Código	Pol.	Int.(A)	P.Corte	Emb.	P.U.€
SL-CP063125	3P	125A	35KA	1	65,00€
SL-CP063160	3P	160A	50KA	1	190,00€
SL-CP063200	3P	200A	50KA	1	240,00€
SL-CP063250	3P	250A	50KA	1	270,00€
SL-CP063300	3P	300A	50KA	1	340,00€
SL-CP063350	3P	350A	50KA	1	510,00€
SL-CP063400	3P	400A	50KA	1	540,00€
SL-CP063500	3P	500A	70KA	1	735,00€
SL-CP063630	3P	630A	70KA	1	905,00€
SL-CP063800	3P	800A	70KA	1	1270,00€

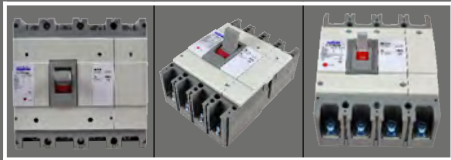

Código	Pol.	Int.(A)	P.Corte	Emb.	P.U.€
SL-CP064125	4P	125A	35KA	1	81,00€
SL-CP064160	4P	160A	50KA	1	42,00€
SL-CP064200	4P	200A	50KA	1	270,00€
SL-CP064250	4P	250A	50KA	1	310,00€
SL-CP064300	4P	300A	50KA	1	405,00€
SL-CP064350	4P	350A	50KA	1	640,00€
SL-CP064400	4P	400A	70KA	1	765,00€
SL-CP064500	4P	500A	70KA	1	1182,00€
SL-CP064630	4P	630A	70KA	1	1225,00€
SL-CP064800	4P	800A	70KA	1	1630,00€

Dimensions and dimensions (mm)

Standard accessories & accessories table

Model	Part	Qty	Part	Qty
SL-CP06-125	SL-CP06-125	1	SL-CP06-125	1
SL-CP06-160	SL-CP06-160	1	SL-CP06-160	1
SL-CP06-200	SL-CP06-200	1	SL-CP06-200	1
SL-CP06-250	SL-CP06-250	1	SL-CP06-250	1
SL-CP06-300	SL-CP06-300	1	SL-CP06-300	1
SL-CP06-350	SL-CP06-350	1	SL-CP06-350	1
SL-CP06-400	SL-CP06-400	1	SL-CP06-400	1
SL-CP06-500	SL-CP06-500	1	SL-CP06-500	1
SL-CP06-630	SL-CP06-630	1	SL-CP06-630	1
SL-CP06-800	SL-CP06-800	1	SL-CP06-800	1

Necessary tools

- Hex key
- Allen key
- Wrench
- Phillips screwdriver
- Flat screwdriver
- Power drill (for 125A)
- Power drill (for 160A)

A Installation setting

B Internal accessories & wiring

C Wires

D Mounting of circuit breaker

E Wiring

F Wire connection

G Mounting auxiliary letter

Acessórios para Disjuntores de Caixa Moldada Electromecânicos

Bobine de Emissão de Corrente Bobine de Mínima Tensão



Código	Descrição	Emb.	P.U.€
SL-CP06-125AUX-MX	Bobine de Disparo p/125A	1	46,00€
SL-CP06-160AUX-MX	Bobine de Disparo p/160A	1	46,00€
SL-CP06-315AUX-MX	Bobine de Disparo p/315A	1	46,00€
SL-CP06-630AUX-MX	Bobine de Disparo p/630A	1	95,00€
SL-CP06-800AUX-MX	Bobine de Disparo p/800A	1	95,00€



Código	Descrição	P.U.€
SL-CP06-125AUX-MN	Bob.Disp.Min.Tensão p/125A	74,00€
SL-CP06-160AUX-MN	Bob.Disp.Min.Tensão p/160A	74,00€
SL-CP06-315AUX-MN	Bob.Disp.Min.Tensão p/315A	96,00€
SL-CP06-630AUX-MN	Bob.Disp.Min.Tensão p/630A	107,00€
SL-CP06-800AUX-MN	Bob.Disp.Min.Tensão p/800A	107,00€

Contacto Auxiliar de Alarme



Código	Descrição	Emb.	P.U.€
SL-CP06-125AUX-AL	Cont. Aux. Alarme p/125A	1	30,00€
SL-CP06-160AUX-AL	Cont. Aux. Alarme p/160A	1	30,00€
SL-CP06-315AUX-AL	Cont. Aux. Alarme p/315A	1	35,00€
SL-CP06-630AUX-AL	Cont. Aux. Alarme p/630A	1	36,50€
SL-CP06-800AUX-AL	Cont. Aux. Alarme p/800A	1	34,00€

Contacto Auxiliar



Código	Descrição	Emb.	P.U.€
SL-CP06-125AUX-OF	Contacto Auxiliar p/125A	1	20,00€
SL-CP06-160AUX-OF	Contacto Auxiliar p/160A	1	25,50€
SL-CP06-315AUX-OF	Contacto Auxiliar p/315A	1	27,50€
SL-CP06-630AUX-OF	Contacto Auxiliar p/630A	1	30,10€
SL-CP06-800AUX-OF	Contacto Auxiliar p/800A	1	30,10€

Interruptores Diferenciais

Interruptores Diferenciais Modulares Tipo AC (IEC 61008)

(Até 63A, Neutro á Direita 80 a 100A, Neutro á Esquerda)

Gama Doméstica, Terciária e Industrial



Tipo AC:

Deteção de Defeitos em Correntes Alternadas

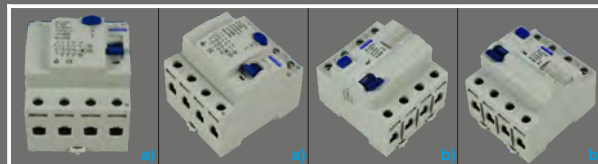

Código	Pol.	Int.(A)	Sens.	Emb.	P.U.€
SL-CP05225-10-AC	2P	25A	10mA	1/60	32,50€
SL-CP05225-30-AC	2P	25A	30mA	1/60	19,10€
SL-CP05240-30-AC	2P	40A	30mA	1/60	19,10€
SL-CP05263-30-AC	2P	63A	30mA	1/60	24,00€

Código	Pol.	Int.(A)	Sens.	Emb.	P.U.€
SL-CP05425-30-AC	4P	25A	30mA	1/30	26,70€
SL-CP05440-30-AC	4P	40A	30mA	1/30	26,70€
SL-CP05463-30-AC	4P	63A	30mA	1/30	27,80€
SL-CP05480-30-AC	4P	80A	30mA	1/30	50,40€
SL-CP054100-30-AC	4P	100A	30mA	1/30	51,60€

Código	Pol.	Int.(A)	Sens.	Emb.	P.U.€
SL-CP05225-300-AC	2P	25A	300mA	1/60	18,70€
SL-CP05240-300-AC	2P	40A	300mA	1/60	18,70€
SL-CP05263-300-AC	2P	63A	300mA	1/60	23,25€

Código	Pol.	Int.(A)	Sens.	Emb.	P.U.€
SL-CP05425-300-AC	4P	25A	300mA	1/30	26,70€
SL-CP05440-300-AC	4P	40A	300mA	1/30	26,70€
SL-CP05463-300-AC	4P	63A	300mA	1/30	28,40€
SL-CP05480-300-AC	4P	80A	300mA	1/30	50,40€
SL-CP054100-300-AC	4P	100A	300mA	1/30	57,95€

Interruptores Diferenciais Modulares Tipo A - Super Imunizados (IEC 61008)

(Até 63A, Neutro á Direita 80 a 100A, Neutro á Esquerda)

Gama Doméstica, Terciária e Industrial



Tipo A:

Deteção de Defeitos em Correntes Alternadas + Deteção de Correntes com Componentes Contínua (DC) Pulsantes

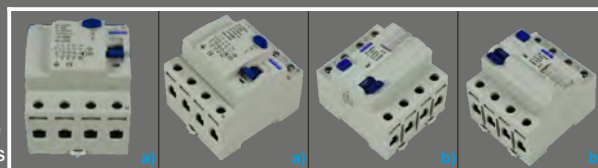

Código	Pol.	Int.(A)	Sens.	Emb.	P.U.€
SL-CP05225-30-A	2P	25A	30mA	1/60	37,80€
SL-CP05240-30-A	2P	40A	30mA	1/60	37,80€
SL-CP05263-30-A	2P	63A	30mA	1/60	39,00€

Código	Pol.	Int.(A)	Sens.	Emb.	P.U.€
SL-CP05425-30-A	4P	25A	30mA	1/30	46,40€
SL-CP05440-30-A	4P	40A	30mA	1/30	46,40€
SL-CP05463-30-A	4P	63A	30mA	1/30	51,00€

Código	Pol.	Int.(A)	Sens.	Emb.	P.U.€
SL-CP05225-300-A	2P	25A	300mA	1/60	37,80€
SL-CP05240-300-A	2P	40A	300mA	1/60	37,80€
SL-CP05263-300-A	2P	63A	300mA	1/60	39,00€
SL-CP05280-300-A	2P	80A	300mA	1/60	50,25€
SL-CP052100-300-A	2P	100A	300mA	1/60	53,00€

Código	Pol.	Int.(A)	Sens.	Emb.	P.U.€
SL-CP05425-300-A	4P	25A	300mA	1/30	51,00€
SL-CP05440-300-A	4P	40A	300mA	1/30	51,00€
SL-CP05463-300-A	4P	63A	300mA	1/30	54,00€
SL-CP05480-300-A	4P	80A	300mA	1/30	61,00€
SL-CP054100-300-A	4P	100A	300mA	1/30	65,50€

Interruptores Diferenciais Modulares Tipo B (IEC 61008)

(Neutro á Esquerda)

Gama Doméstica, Terciária e Industrial



Tipo B:

Inclui Três Tecnologias de Deteção de Fuga:
* Detetor Electro-magnético (tipo A)
* Detetor Eletrónico p/Correntes de Defeito Contínuas
* Filtro de Altas Frequências



Código	Pol.	Int.(A)	Sens.	Emb.	P.U.€
SL-CP05225-30-B	2P	25A	30mA	1/60	480,00€
SL-CP05240-30-B	2P	40A	30mA	1/60	480,00€
SL-CP05263-30-B	2P	63A	30mA	1/60	490,00€

Código	Pol.	Int.(A)	Sens.	Emb.	P.U.€
SL-CP05425-30-B	4P	25A	30mA	1/30	540,00€
SL-CP05440-30-B	4P	40A	30mA	1/30	540,00€
SL-CP05463-30-B	4P	63A	30mA	1/30	550,00€

Código	Pol.	Int.(A)	Sens.	Emb.	P.U.€
SL-CP05225-300-B	2P	25A	300mA	1/60	480,00€
SL-CP05240-300-B	2P	40A	300mA	1/60	480,00€
SL-CP05263-300-B	2P	63A	300mA	1/60	490,00€

Código	Pol.	Int.(A)	Sens.	Emb.	P.U.€
SL-CP05425-300-B	4P	25A	300mA	1/30	540,00€
SL-CP05440-300-B	4P	40A	300mA	1/30	540,00€
SL-CP05463-300-B	4P	63A	300mA	1/30	550,00€

Diferenciais Modulares Rearmáveis Tipo A - Super Imunizados (IEC 61008)

Gama Doméstica, Terciária e Industrial



* Até 6 Rearmes
 * Aumento tempo rearme depois de cada ligação
 * Possibilidade controlo Remoto
 * Detecção de Defeitos em Correntes Alternadas + Detecção de Correntes com Componentes Contínua (DC) Pulsantes

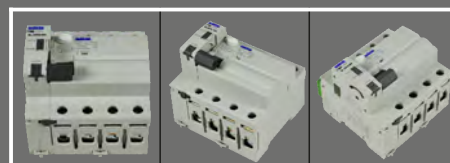

Código	Pol.	Int.(A)	Sens.	Emb.	P.U.€
SL-CP05-RA240-30-A	2P	40A	30mA	1/60	135,00€
SL-CP05-RA263-30-A	2P	63A	30mA	1/60	138,00€

Código	Pol.	Int.(A)	Sens.	Emb.	P.U.€
SL-CP05-RA440-30-A	4P	40A	30mA	1/30	195,00€
SL-CP05-RA463-30-A	4P	63A	30mA	1/30	240,00€
SL-CP05-RA480-30-A	4P	80A	30mA	1/30	263,00€

Código	Pol.	Int.(A)	Sens.	Emb.	P.U.€
SL-CP05-RA240-300-A	2P	40A	300mA	1/60	135,00€
SL-CP05-RA263-300-A	2P	63A	300mA	1/60	138,00€

Código	Pol.	Int.(A)	Sens.	Emb.	P.U.€
SL-CP05-RA440-300-A	4P	40A	300mA	1/30	195,00€
SL-CP05-RA463-300-A	4P	63A	300mA	1/30	240,00€
SL-CP05-RA480-300-A	4P	80A	300mA	1/30	263,00€

Novos
Podutos

Disjuntores Diferenciais Modulares 6kA Curva C, Tipo AC

Gama Doméstica, Terciária e Industrial

(IEC 61008)



Tipo AC:
 Detecção de Defeitos em Correntes Alternadas



Código	Pol.	Int.(A)	Sens.	Emb.	P.U.€
SL-CP02506DF30-AC	F+N	6A	30mA	1/60	25,00€
SL-CP02510DF30-AC	F+N	10A	30mA	1/60	25,00€
SL-CP02516DF30-AC	F+N	16A	30mA	1/60	25,00€
SL-CP02520DF30-AC	F+N	20A	30mA	1/60	25,00€
SL-CP02525DF30-AC	F+N	25A	30mA	1/60	25,00€
SL-CP02532DF30-AC	F+N	32A	30mA	1/60	25,00€
SL-CP02540DF30-AC	F+N	40A	30mA	1/60	27,00€
SL-CP02550DF30-AC	F+N	50A	30mA	1/60	27,00€
SL-CP02563DF30-AC	F+N	63A	30mA	1/60	27,00€

Código	Pol.	Int.(A)	Sens.	Emb.	P.U.€
SL-CP02506DF300-AC	F+N	6A	300mA	1/60	25,00€
SL-CP02510DF300-AC	F+N	10A	300mA	1/60	25,00€
SL-CP02516DF300-AC	F+N	16A	300mA	1/60	25,00€
SL-CP02520DF300-AC	F+N	20A	300mA	1/60	25,00€
SL-CP02525DF300-AC	F+N	25A	300mA	1/60	25,00€
SL-CP02532DF300-AC	F+N	32A	300mA	1/60	25,00€
SL-CP02540DF300-AC	F+N	40A	300mA	1/60	27,00€
SL-CP02550DF300-AC	F+N	50A	300mA	1/60	27,00€
SL-CP02563DF300-AC	F+N	63A	300mA	1/60	27,00€



Tipo AC:
 Detecção de Defeitos em Correntes Alternadas



Código	Pol.	Int.(A)	Sens.	Emb.	P.U.€
SL-CP02406DF30-AC	4P	6A	30mA	1/60	55,00€
SL-CP02410DF30-AC	4P	10A	30mA	1/60	55,00€
SL-CP02416DF30-AC	4P	16A	30mA	1/60	55,00€
SL-CP02420DF30-AC	4P	20A	30mA	1/60	55,00€
SL-CP02425DF30-AC	4P	25A	30mA	1/60	55,00€
SL-CP02432DF30-AC	4P	32A	30mA	1/60	55,00€
SL-CP02440DF30-AC	4P	40A	30mA	1/60	59,00€
SL-CP02450DF30-AC	4P	50A	30mA	1/60	59,00€
SL-CP02463DF30-AC	4P	63A	30mA	1/60	59,00€

Código	Pol.	Int.(A)	Sens.	Emb.	P.U.€
SL-CP02406DF300-AC	4P	6A	300mA	1/60	55,00€
SL-CP02410DF300-AC	4P	10A	300mA	1/60	55,00€
SL-CP02416DF300-AC	4P	16A	300mA	1/60	55,00€
SL-CP02420DF300-AC	4P	20A	300mA	1/60	55,00€
SL-CP02425DF300-AC	4P	25A	300mA	1/60	55,00€
SL-CP02432DF300-AC	4P	32A	300mA	1/60	55,00€
SL-CP02440DF300-AC	4P	40A	300mA	1/60	59,00€
SL-CP02450DF300-AC	4P	50A	300mA	1/60	59,00€
SL-CP02463DF300-AC	4P	63A	300mA	1/60	59,00€

Bases Para Relés



Código	Descrição	Qt.Emb.	P.U.€
SL-CP-9022	Base para relé 8 Pinos	400/20	3,30€
SL-CP-9023	Base para Relé 11 Pinos	400/20	3,30€



Código	Descrição	Qt.Emb.	P.U.€
SL-CP-PF083A-E	Base para Relé 8 Pinos	400/20	1,95€
SL-CP-PF113A-E	Base para Relé 11 Pinos	400/20	1,95€

Interruptores Modulares

(IEC 60947-3)

Gama Terciária e Industrial



Código	Pol.	Int.(A)	Emb.	P.U.€
SL-CP08132	1P	32A	12/180	3,75€
SL-CP08163	1P	63A	12/180	4,00€



Código	Pol.	Int.(A)	Emb.	P.U.€
SL-CP08232	2P	32A	6/90	8,60€
SL-CP08263	2P	63A	6/90	9,20€

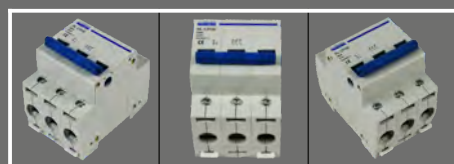

Código	Pol.	Int.(A)	Emb.	P.U.€
SL-CP08332	3P	32A	4/60	11,20€
SL-CP08363	3P	63A	4/60	12,00€
SL-CP08380	3P	80A	4/60	12,70€
SL-CP083100	3P	100A	4/60	13,60€

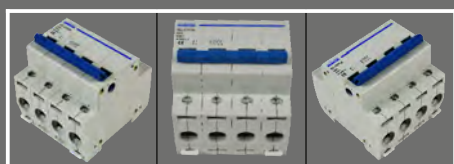

Código	Pol.	Int.(A)	Emb.	P.U.€
SL-CP08432	4P	32A	3/45	17,50€
SL-CP08463	4P	63A	3/45	17,90€
SL-CP08480	4P	80A	3/45	21,90€
SL-CP084100	4P	100A	3/45	23,70€
SL-CP084125	4P	125A	3/45	29,00€

Interruptores Horários Analógicos

(73/23EEC - 89/336/EEC)

Gama Terciária e Industrial

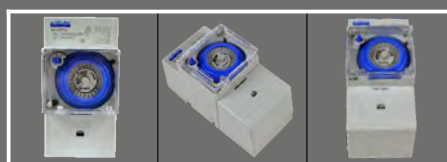

Código	Modulos	Tipo	Int.(A)	Emb.	P.U.€
SL-CP12010	3	Analógico	16A	100	45,25€

* Funcionam. Síncrono ou Quartzo
* Programação Diário (24h):
* 1 Canal, Manobra Mínimo 30min.
30 minutos x 48 Vezes
* Contactos: 1NO+1NC
* 230Vac / 16A
* Bateria Reserva: 150h
* Temp. trabalho: -40 + 55°C

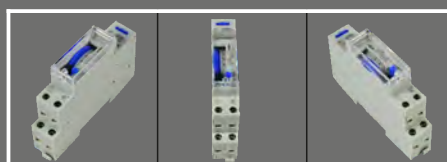

Código	Modulos	Tipo	Int.(A)	Emb.	P.U.€
SL-CP12020	1	Analógico	16A	200	36,55€

* Func. Síncrono ou Quartzo
* Programação Diário (24h):
* 1 Canal, Manobra Mínimo 15min.
15 minutos x 96 Vezes
* Contactos: 1NO
* 230Vac / 16A
* Bateria Reserva: 70h
* Temp. Trabalho: -10 + 50°C

Interruptor Horário Digital

(73/23EEC - 89/336/EEC)



Código	Modulos	Tipo	Int.(A)	Emb.	P.U.€
SL-CP12025	2	Digital	16A	200	40,35€

* Funcionamento: Digital
* Programação: Diário/Semanal
* 1 Canal, Manobra 0,5 minutos
* Contactos: 1NO+1NC
* 230Vac / 12A
* Bateria Reserva: 60 dias
* Temp. Trabalho: 0 + 40°C

Automático Escada

(EN60947-5-1)

Gama Doméstica



Código	Modulos	Int.(A)	Temp.	Emb.	P.U.€
SL-CP12030	1	16A	0,5-20m	12	19,95€

* Automático/Manual (30s a 20m)
* Ligação: 3 e 4 Fios
* 230Vac / 16A
* Led: 750W
* Fluorescente: 750W
* Baixo Consumo: 750W
* Halogênio: 2000W
* Temp. Trabalho: 40 + 55°C

Contactores Modulares (IEC61095 / EN61095)

Gama Terciária e Industrial



Código	Contatos	Tensão Bobine	Numero Modulos	Int.	P.U.€
SL-CP17225-1NO1NC-024	1NO1NC	24Vac	1	25A	18,75€
SL-CP17225-2NO-024	2NO	24Vac	1	25A	18,75€
SL-CP17225-1NO1NC-230	1NO1NC	240Vac	1	25A	18,75€
SL-CP17225-2NO-230	2NO	240Vac	1	25A	18,75€



Código	Contatos	Tensão Bobine	Numero Modulos	Int.	P.U.€
SL-CP17425-2NO2NC-024	2NO2NC	24Vac	2	25A	38,55€
SL-CP17425-4NO-024	4NO	24Vac	2	25A	38,55€
SL-CP17425-2NO2NC-230	2NO2NC	240Vac	2	25A	38,55€
SL-CP17425-4NO-230	4NO	240Vac	2	25A	38,55€



Código	Contatos	Tensão Bobine	Numero Modulos	Int.	P.U.€
SL-CP17463-2NO2NC-024	2NO2NC	24Vac	3	63A	42,50€
SL-CP17463-4NO-024	4NO	24Vac	3	63A	42,50€
SL-CP17463-2NO2NC-230	2NO2NC	240Vac	3	63A	42,50€
SL-CP17463-4NO-230	4NO	240Vac	3	63A	42,50€

Campainha Modular (IEC 61558-1 / EN 61558-2-8)

Gama Terciária e Industrial



Código	Tensão Bobine	Inten.	Emb.	P.U.€
SL-CP1010-024	24Vac	6.5Va	12/180	4,90€
SL-CP1010-240	240Vac	6.5Va	12/180	4,90€

Transformador Modular (IEC 61558-1 / EN 61558-2-8)

Gama Terciária e Industrial

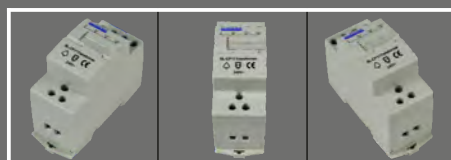

Código	Numero Modulos	Opcões Voltagem	Inten.	Emb.	P.U.€
SL-CP11024	2	8/12/24V	8VA	100	13,35€

Telerruptor Modular

Gama Terciária e Industrial



Código	Nº Pol.	Inten.	Tensão Bobine	Emb.	P.U.€
SL-CP12050-1NO-024	1P	16A	24V	12	16,80€
SL-CP12050-1NO-230	1P	16A	230V	12	16,80€

Sinalizadores Modulares (IEC 60947-5-1)

Gama Terciária e Industrial



Código	Numero Modulos	Cor	Embalagem	P.U.€
SL-CP091RD	1	Vermelho	12/180	3,80€
SL-CP091YE	1	Amarelo	12/180	3,80€
SL-CP091GR	1	Verde	12/180	3,80€

Sinalizadores Modulares (VM/VD/AM)

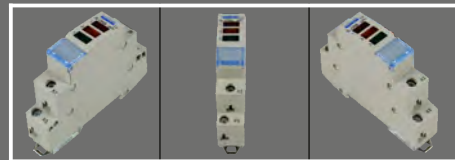

Código	Numero Modulos	Cor	Embalagem	P.U.€
SL-CP091RYG	1P	V/A/V	12/180	8,00€

Tomada Modular Schuko c/Alvéolos

Gama Doméstica, Terciária e Industrial



Código	Numero Modulos	Nº Pol.	Intensidade	Emb.	P.U.€
SL-CP13016	2,5	2P+T	16A	200	4,90€



Código	Pólos	Pot.Motor KW	400V AC3 CV	AC3 A	Ac1 A	Aux.	Tensão Bobine	P.U.€
SL-CP15012NO-024	3	5,5	7,5	12	20	NO	24V	10,70€
SL-CP15012NC-024	3	5,5	7,5	12	20	NC	24V	10,70€
SL-CP15012NO-048	3	5,5	7,5	12	20	NO	48V	10,70€
SL-CP15012NC-048	3	5,5	7,5	12	20	NC	48V	10,70€
SL-CP15012NO-110	3	5,5	7,5	12	20	NO	110V	10,70€
SL-CP15012NC-110	3	5,5	7,5	12	20	NC	110V	10,70€
SL-CP15012NO-220	3	5,5	7,5	12	20	NO	230V	10,70€
SL-CP15012NC-220	3	5,5	7,5	12	20	NC	230V	10,70€
SL-CP15012NO-380	3	5,5	7,5	12	20	NO	400V	10,70€
SL-CP15012NC-380	3	5,5	7,5	12	20	NC	400V	10,70€

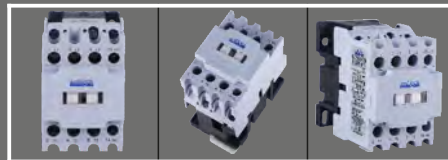

Código	Pólos	Pot.Motor KW	400V AC3 CV	AC3 A	Ac1 A	Aux.	Tensão Bobine	P.U.€
SL-CP15018NO-024	3	7,5	10	18	32	NO	24V	13,90€
SL-CP15018NC-024	3	7,5	10	18	32	NC	24V	13,90€
SL-CP15018NO-048	3	7,5	10	18	32	NO	48V	13,90€
SL-CP15018NC-048	3	7,5	10	18	32	NC	48V	13,90€
SL-CP15018NO-110	3	7,5	10	18	32	NO	110V	13,90€
SL-CP15018NC-110	3	7,5	10	18	32	NC	110V	13,90€
SL-CP15018NO-220	3	7,5	10	18	32	NO	230V	13,90€
SL-CP15018NC-220	3	7,5	10	18	32	NC	230V	13,90€
SL-CP15018NO-380	3	7,5	10	18	32	NO	400V	13,90€
SL-CP15018NC-380	3	7,5	10	18	32	NC	400V	13,90€



Código	Pólos	Pot.Motor KW	400V AC3 CV	AC3 A	Ac1 A	Aux.	Tensão Bobine	P.U.€
SL-CP15025NO-024	3	11	15	25	40	NO	24V	18,95€
SL-CP15025NC-024	3	11	15	25	40	NC	24V	18,95€
SL-CP15025NO-048	3	11	15	25	40	NO	48V	18,95€
SL-CP15025NC-048	3	11	15	25	40	NC	48V	18,95€
SL-CP15025NO-110	3	11	15	25	40	NO	110V	18,95€
SL-CP15025NC-110	3	11	15	25	40	NC	110V	18,95€
SL-CP15025NO-220	3	11	15	25	40	NO	230V	18,95€
SL-CP15025NC-220	3	11	15	25	40	NC	230V	18,95€
SL-CP15025NO-380	3	11	15	25	40	NO	400V	18,95€
SL-CP15025NC-380	3	11	15	25	40	NC	400V	18,95€



Código	Pólos	Pot.Motor KW	400V AC3 CV	AC3 A	Ac1 A	Aux.	Tensão Bobine	P.U.€
SL-CP15032NO-024	3	15	20	32	50	NO	24V	22,70€
SL-CP15032NC-024	3	15	20	32	50	NC	24V	22,70€
SL-CP15032NO-048	3	15	20	32	50	NO	48V	22,70€
SL-CP15032NC-048	3	15	20	32	50	NC	48V	22,70€
SL-CP15032NO-110	3	15	20	32	50	NO	110V	22,70€
SL-CP15032NC-110	3	15	20	32	50	NC	110V	22,70€
SL-CP15032NO-220	3	15	20	32	50	NO	230V	22,70€
SL-CP15032NC-220	3	15	20	32	50	NC	230V	22,70€
SL-CP15032NO-380	3	15	20	32	50	NO	400V	22,70€
SL-CP15032NC-380	3	15	20	32	50	NC	400V	22,70€



Código	Pólos	Pot.Motor KW	400V AC3 CV	AC3 A	Ac1 A	Aux.	Tensão Bobine	P.U.€
SL-CP15040NO/NC-024	3	18,5	25	40	60	NO/NC	24V	54,20€
SL-CP15040NO/NC-048	3	18,5	25	40	60	NO/NC	48V	54,20€
SL-CP15040NO/NC-110	3	18,5	25	40	60	NO/NC	110V	54,20€
SL-CP15040NO/NC-220	3	18,5	25	40	60	NO/NC	230V	54,20€
SL-CP15040NO/NC-380	3	18,5	25	40	60	NO/NC	400V	54,20€



Código	Pólos	Pot.Motor KW	400V AC3 CV	AC3 A	Ac1 A	Aux.	Tensão Bobine	P.U.€
SL-CP15050NO/NC-024	3	22	30	50	80	NO/NC	24V	58,60€
SL-CP15050NO/NC-048	3	22	30	50	80	NO/NC	48V	58,60€
SL-CP15050NO/NC-110	3	22	30	50	80	NO/NC	110V	58,60€
SL-CP15050NO/NC-220	3	22	30	50	80	NO/NC	230V	58,60€
SL-CP15050NO/NC-380	3	22	30	50	80	NO/NC	400V	58,60€



Código	Pólos	Pot.Motor KW	400V AC3 CV	AC3 A	Ac1 A	Aux.	Tensão Bobine	P.U.€
SL-CP15065NO/NC-024	3	30	40	65	80	NO/NC	24V	62,35€
SL-CP15065NO/NC-048	3	30	40	65	80	NO/NC	48V	62,35€
SL-CP15065NO/NC-110	3	30	40	65	80	NO/NC	110V	62,35€
SL-CP15065NO/NC-220	3	30	40	65	80	NO/NC	230V	62,35€
SL-CP15065NO/NC-380	3	30	40	65	80	NO/NC	400V	62,35€



Código	Pólos	Pot.Motor KW	400V AC3 CV	AC3 A	Ac1 A	Aux.	Tensão Bobine	P.U.€
SL-CP15080NO/NC-024	3	37	50	80	125	NO/NC	24V	81,90€
SL-CP15080NO/NC-048	3	37	50	80	125	NO/NC	48V	81,90€
SL-CP15080NO/NC-110	3	37	50	80	125	NO/NC	110V	81,90€
SL-CP15080NO/NC-220	3	37	50	80	125	NO/NC	230V	81,90€
SL-CP15080NO/NC-380	3	37	50	80	125	NO/NC	400V	81,90€



Código	Pólos	Pot.Motor KW	400V AC3 CV	AC3 A	Ac1 A	Aux.	Tensão Bobine	P.U.€
SL-CP15095NO/NC-024	3	45	80	95	125	NO/NC	24V	95,35€
SL-CP15095NO/NC-048	3	45	80	95	125	NO/NC	48V	95,35€
SL-CP15095NO/NC-110	3	45	80	95	125	NO/NC	110V	95,35€
SL-CP15095NO/NC-220	3	45	80	95	125	NO/NC	230V	95,35€
SL-CP15095NO/NC-380	3	45	80	95	125	NO/NC	400V	95,35€

Contacto Lateral Auxiliar p/Contactor

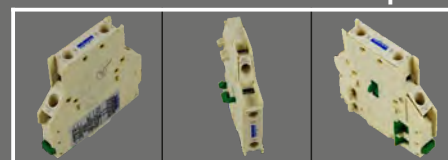

Código	Descrição	Contacto	Embal.	P.U.€
SL-CP15AUX-A8/11	Contacto Auxiliar	1NO+1NC	1/100	9,20€



Novos Podutos

Código	Pólos	Pot.Motor KW	400V CV	AC3 A	Ac1 A	Tensão Bobine	P.U.€
SL-CP15012-4P-024	4	5,5	7,5	12	20	24V	20,00€
SL-CP15012-4P-230	4	5,5	7,5	12	20	230V	20,00€
SL-CP15012-4P-400	4	5,5	7,5	12	20	400V	20,00€



Novos Podutos

Código	Pólos	Pot.Motor KW	400V CV	AC3 A	Ac1 A	Tensão Bobine	P.U.€
SL-CP15018-4P-024	4	7,5	10	18	32	24V	23,00€
SL-CP15018-4P-230	4	7,5	10	18	32	230V	23,00€
SL-CP15018-4P-400	4	7,5	10	18	32	400V	23,00€



Novos Podutos

Código	Pólos	Pot.Motor KW	400V CV	AC3 A	Ac1 A	Tensão Bobine	P.U.€
SL-CP15032-4P-024	4	15	20	32	50	24V	36,00€
SL-CP15032-4P-230	4	15	20	32	50	230V	36,00€
SL-CP15032-4P-400	4	15	20	32	50	400V	36,00€



Novos Podutos

Código	Pólos	Pot.Motor KW	400V CV	AC3 A	Ac1 A	Tensão Bobine	P.U.€
SL-CP15050-4P-024	4	22	30	50	80	24V	80,00€
SL-CP15050-4P-230	4	22	30	50	80	230V	80,00€
SL-CP15050-4P-400	4	22	30	50	80	400V	80,00€



Novos Podutos

Código	Pólos	Pot.Motor KW	400V CV	AC3 A	Ac1 A	Tensão Bobine	P.U.€
SL-CP15095-4P-024	4	45	80	95	125	24V	130,00€
SL-CP15095-4P-230	4	45	80	95	125	230V	130,00€
SL-CP15095-4P-400	4	45	80	95	125	400V	130,00€



Novos Podutos

Código	Pólos	Pot.Motor KW	400V CV	AC3 A	Ac1 A	Tensão Bobine	P.U.€
SL-CP150150-4P-024	4	75	100	150	220	24V	340,00€
SL-CP150150-4P-230	4	75	100	150	220	230V	340,00€
SL-CP150150-4P-400	4	75	100	150	220	400V	340,00€



Novos Podutos

Código	Pólos	Pot.Motor KW	400V CV	AC3 A	Ac1 A	Tensão Bobine	P.U.€
SL-CP150225-4P-024	4	110	150	225	275	24V	450,00€
SL-CP150225-4P-230	4	110	150	225	275	230V	450,00€
SL-CP150225-4P-400	4	110	150	225	275	400V	450,00€



Novos Podutos

Código	Pólos	Pot.Motor KW	400V CV	AC3 A	Ac1 A	Tensão Bobine	P.U.€
SL-CP150400-4P-024	4	200	270	400	450	24V	950,00€
SL-CP150400-4P-230	4	200	270	400	450	230V	950,00€
SL-CP150400-4P-400	4	200	270	400	450	400V	950,00€

Contactores DC (IEC 947)
Gama Industrial



Código	Pólos	Pot.Motor KW	400V CV	AC3 A	Ac1 A	Aux.	Tensão Bobine	P.U.€
SL-CP15018NO-024DC	3	5,5	7,5	12	20	NO	24Vdc	48,00€
SL-CP15018NC-024DC	3	5,5	7,5	12	20	NC	24Vdc	48,00€



Código	Pólos	Pot.Motor KW	400V CV	AC3 A	Ac1 A	Aux.	Tensão Bobine	P.U.€
SL-CP15032NO-024DC	3	5,5	7,5	12	20	NO	24Vdc	91,00€
SL-CP15032NC-024DC	3	5,5	7,5	12	20	NC	24Vdc	91,00€



Código	Pot.Motor KW	400V CV	AC3 A	Ac1 A	Aux.	Tensão Bobine	P.U.€
SL-CP15050-024DC	5,5	7,5	12	20	NO+NC	24Vdc	170,00€

Inversor Manual



Inversor Motorizado



Código	Polos	Amperes	Emb.	P.U.€
SL-CP704160	4P	160A	1	320,00€
SL-CP704250	4P	250A	1	455,00€
SL-CP704400	4P	400A	1	669,00€
SL-CP704630	4P	630A	1	925,00€
SL-CP704800	4P	800A	1	1495,00€
SL-CP7041250	4P	1250A	1	2170,00€
SL-CP7041600	4P	1600A	1	2740,00€

Código	Polos	Amperes	Emb.	P.U.€
SL-CP714160	4P	160A	1	1250,00€
SL-CP714400	4P	400A	1	1410,00€
SL-CP714630	4P	630A	1	1600,00€
SL-CP7141000	4P	1000A	1	2495,00€
SL-CP7141250	4P	1250A	1	2845,00€

Controlador para inversor

Novos
Podutos



Código	Descrição	Emb.	P.U.€
SL-CP71-ATS4-I	Controlador para Inversor	1	250,00€

Inversor Manual / Automático 1-0-2 / 125A

Novos
Podutos



Código	Polos	Amperes	Emb.	P.U.€
SL-CP7241125	4P	125A	1	250,00€

Inversor Modular Manual 2P

Novos
Podutos



Código	Polos	Amperes	Emb.	P.U.€
SL-CP25240	2P	40A	6	13,00€
SL-CP252125	2P	125A	6	40,00€

Inversor Modular Manual 4P

Novos
Podutos



Código	Polos	Amperes	Emb.	P.U.€
SL-CP25440	4P	40A	3	26,00€
SL-CP254125	4P	125A	3	78,00€

Contador Energia Monofásico



Código	Polos	Amp.	Comunicação	P.U.€
CTE-1PH100A-MB	F/N	100A	Modbus/RS485	57,50€

Contador Energia Trifásico



Código	Polos	Amp.	Comunicação	P.U.€
CTE-3PH80A-MB	3P	80A	Modbus/RS485	120,00€

Relés Têrmicos p/ Contactores AC (IEC 947)



Código	Escala de Regulação	Para Contact. SL-CP15...	Emb.	P.U.€
SL-CP16D1303	0,25-0,40A	9 a 32A	1/100	10,25€
SL-CP16D1304	0,40-0,63A	9 a 32A	1/100	10,25€
SL-CP16D1305	0,63-1A	9 a 32A	1/100	10,25€
SL-CP16D1306	1-1,6A	9 a 32A	1/100	10,25€
SL-CP16D1307	1,5-2,5A	9 a 32A	1/100	10,25€
SL-CP16D1308	2,5-4A	9 a 32A	1/100	10,25€
SL-CP16D1310	4-6A	9 a 32A	1/100	10,25€
SL-CP16D1312	5,5-8A	9 a 32A	1/100	10,25€
SL-CP16D1314	07-10A	9 a 32A	1/100	10,25€
SL-CP16D1316	9-13A	9 a 32A	1/100	10,25€
SL-CP16D1321	12-18A	9 a 32A	1/100	10,25€
SL-CP16D1322	17-25A	9 a 32A	1/100	10,25€
SL-CP16D2353	23-32A	40 a 95A	1/100	26,70€
SL-CP16D2355	28-36A	40 a 95A	1/100	26,70€
SL-CP16D3355	30-40A	40 a 95A	1/100	26,70€

Temporizadores pneumáticos para Contactores SL-CP15... (IEC 947)



* Atraso à Operação
* Montagem Frontal
* 1NO + 1 NC

Código	Escala	Embalagem	P.U.€
SL-CP15TEMP-T0	0,1 a 3 Segundos	1/100	24,00€
SL-CP15TEMP-T2	0,1 a 30 Segundos	1/100	24,00€
SL-CP15TEMP-T4	10 a 180 Segundos	1/100	24,00€

Contactos Auxiliares p/ Contactores SL-CP15..., Montagem Frontal



Código	Descrição	Contacto	Emb.	P.U.€
SL-CP15AUX-A02	Contacto Auxiliar	2NC	1/100	4,15€
SL-CP15AUX-A11	Contacto Auxiliar	1NO+1NC	1/100	4,15€
SL-CP15AUX-A20	Contacto Auxiliar	2NO	1/100	4,15€



Código	Descrição	Contacto	Emb.	P.U.€
SL-CP15AUX-A04	Contacto Auxiliar	4NC	1/100	6,75€
SL-CP15AUX-A13	Contacto Auxiliar	1NO+3NC	1/100	6,75€
SL-CP15AUX-A22	Contacto Auxiliar	2NO+2NC	1/100	6,75€
SL-CP15AUX-A31	Contacto Auxiliar	3NO+1NC	1/100	6,75€
SL-CP15AUX-A40	Contacto Auxiliar	4NO	1/100	6,75€

Bobines para Contactores AC, SL-CP15...



Código	Para Contactor	Tensão Bobine	Emb.	P.U.€
SL-CP15B18024	9-18A	24V	1/20	4,25€
SL-CP15B18048	9-18A	48V	1/20	4,25€
SL-CP15B18110	9-18A	110V	1/20	4,25€
SL-CP15B18220	9-18A	220V	1/20	4,25€
SL-CP15B18380	9-18A	380V	1/20	4,25€



Código	Para Contactor	Tensão Bobine	Emb.	P.U.€
SL-CP15B32024	25-32A	24V	1/20	5,20€
SL-CP15B32048	25-32A	48V	1/20	5,20€
SL-CP15B32110	25-32A	110V	1/20	5,20€
SL-CP15B32220	25-32A	220V	1/20	5,20€
SL-CP15B32380	25-32A	380V	1/20	5,20€

Encravamento Mecânico p/Cont.



Código	Para Contactor	Tensão Bobine	Emb.	P.U.€
SL-CP15B95024	40-95A	24V	1/20	9,00€
SL-CP15B95048	40-95A	48V	1/20	9,00€
SL-CP15B95110	40-95A	110V	1/20	9,00€
SL-CP15B95220	40-95A	220V	1/20	9,00€
SL-CP15B95380	40-95A	380V	1/20	9,00€



Código	Para Contactor	Embalagem	P.U.€
SL-CP15ENC-9-32A	9 a 32A	120	3,80€
SL-CP15ENC-40-95A	40 a 95A	40	5,90€

Mini Contatores (IEC 60947-4-1)



Código	Pólos	Prot. Motor KW	400V AC3 CV	A	Ac1 A	Aux.	Tensão Bobine	P.U.€
SL-CP21012NO-024	3	5,5	7,5	12	20	NO	24V	15,50€
SL-CP21012NC-024	3	5,5	7,5	12	20	NC	24V	15,50€
SL-CP21012NO-220	3	5,5	7,5	12	20	NO	230V	15,50€
SL-CP21012NC-220	3	5,5	7,5	12	20	NC	230V	15,50€
SL-CP21012NO-380	3	5,5	7,5	12	20	NO	400V	15,50€
SL-CP21012NC-380	3	5,5	7,5	12	20	NC	400V	15,50€

Relés Térmicos Mini Contatores (IEC 60947-4-1)



Código	Escala de Regulação	Para Contactor	Emb.	P.U.€
SL-CP211307	1,2-1,8A	SL-CP21...	1/10	24,00€
SL-CP211308	1,8-2,6A	SL-CP21...	1/10	24,00€
SL-CP211309	2,6-3,7A	SL-CP21...	1/10	24,00€
SL-CP211310	3,7-5,5A	SL-CP21...	1/10	24,00€
SL-CP211311	5,5-8,0A	SL-CP21...	1/10	24,00€
SL-CP211312	8,0-11,5A	SL-CP21...	1/10	24,00€

Discontactor sem Relé Térmico



Código	Descrição	Tensão Bobine	Emb.	P.U.€
SL-CP22018-230	Contactador 18A	230V	1/100	30,00€
SL-CP22018-380	Contactador 18A	400V	1/100	30,00€
SL-CP22032-230	Contactador 32A	230V	1/100	56,00€
SL-CP22032-380	Contactador 32A	400V	1/100	56,00€

Limitador Sobre tensão (IEC61643.1)

Gama Terciária e Industrial



* Tipo: 2
* Numero Polos: 2
* Voltagem Max.: 275Vac
* Corrente:
Mínima Descarga: 20kA
Máxima Descarga: 40kA
* Nivel Protecção Tensão 1,8kV
* Temper. Trabalho: -40 a 80°C

Código	Numero Módulos	Descrição	Emb.	P.U.€
SL-CP14240KA	2P	20-40KA 275V T1+T2.	136	47,00€

Disjuntor Motor Magneto-Térmico 3P (IEC947-2,947-4-1)



Código	Descrição	Escala de Regulação	Emb.	P.U.€
SL-CP19V2M01	Disjuntor Motor	0,63-1A	1/50	34,00€
SL-CP19V2M02	Disjuntor Motor	1-1,6A	1/50	34,00€
SL-CP19V2M03	Disjuntor Motor	1,6-2,5A	1/50	34,00€
SL-CP19V2M04	Disjuntor Motor	2,5-4A	1/50	34,00€
SL-CP19V2M05	Disjuntor Motor	4-6,3A	1/50	34,00€
SL-CP19V2M06	Disjuntor Motor	6-10A	1/50	34,00€
SL-CP19V2M07	Disjuntor Motor	9-14A	1/50	34,00€
SL-CP19V2M08	Disjuntor Motor	13-18A	1/50	34,00€
SL-CP19V2M09	Disjuntor Motor	17-23A	1/50	34,00€
SL-CP19V2M10	Disjuntor Motor	20-25A	1/50	34,00€
SL-CP19V2M11	Disjuntor Motor	24-32A	1/50	34,00€

Caixa para Disjuntor Motor



Código	Descrição	Embal.	P.U.€
SL-CP19V2MC02	Caixa Vazia p/ Disjuntor Motor	1/100	14,00€

Contacto Auxiliar Lateral p/ Disj. Motor



Código	Descrição	Contacto	Embalagem	P.U.€
SL-CP19V2AN11	Contacto Auxiliar	1NO+1NC	1/50	9,10€
SL-CP19V2AN20	Contacto Auxiliar	2NO	1/50	9,10€

Contacto Auxiliar Frontal p/ Disj. Motor



Novos
Podutos

Código	Descrição	Contacto	Embalagem	P.U.€
SL-CP19EA11	Contacto Auxiliar	1NO+1NC	1/50	8,60€

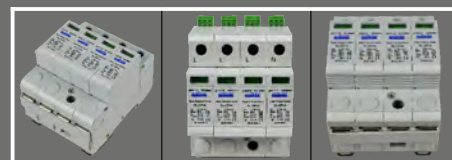

* Tipo: 2
* Numero Polos: 4
* Voltagem Max.: 415Vac
* Corrente:
Mínima Descarga: 20kA
Máxima Descarga: 40kA
* Nivel Protecção Tensão 1,8kV
* Temper. Trabalho: -40 a 80°C

Código	Numero Módulos	Descrição	Emb.	P.U.€
SL-CP14440KA	4P	20-40KA 415V T1+T2.	114	101,00€

Fusíveis Cilíndricos (IEC60269)

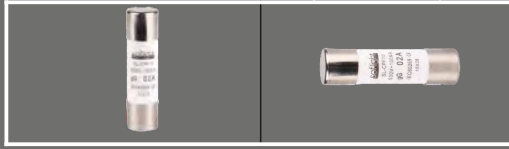

Código	Fusível	Int.(A)	Emb.	P.U.€
SL-CP10X38-02A-gG	10x38	2A	10un.	0,28€
SL-CP10X38-04A-gG	10x38	4A	10un.	0,28€
SL-CP10X38-06A-gG	10x38	6A	10un.	0,28€
SL-CP10X38-08A-gG	10x38	8A	10un.	0,28€
SL-CP10X38-10A-gG	10x38	10A	10un.	0,28€
SL-CP10X38-12A-gG	10x38	12A	10un.	0,28€
SL-CP10X38-16A-gG	10x38	16A	10un.	0,28€
SL-CP10X38-20A-gG	10x38	20A	10un.	0,28€
SL-CP10X38-25A-gG	10x38	25A	10un.	0,28€
SL-CP10X38-32A-gG	10x38	32A	10un.	0,28€



Código	Fusível	Int.(A)	Emb.	P.U.€
SL-CP14X51-10A-gG	14x51	10A	10un.	0,75€
SL-CP14X51-12A-gG	14x51	12A	10un.	0,75€
SL-CP14X51-16A-gG	14x51	16A	10un.	0,75€
SL-CP14X51-20A-gG	14x51	20A	10un.	0,75€
SL-CP14X51-25A-gG	14x51	25A	10un.	0,75€
SL-CP14X51-32A-gG	14x51	32A	10un.	0,75€
SL-CP14X51-40A-gG	14x51	40A	10un.	0,75€
SL-CP14X51-50A-gG	14x51	50A	10un.	0,75€
SL-CP14X51-63A-gG	14x51	63A	10un.	0,75€



Código	Fusível	Int.(A)	Emb.	P.U.€
SL-CP22X58-10A-gG	22x58	10A	10un.	1,20€
SL-CP22X58-16A-gG	22x58	16A	10un.	1,20€
SL-CP22X58-20A-gG	22x58	20A	10un.	1,20€
SL-CP22X58-25A-gG	22x58	25A	10un.	1,20€
SL-CP22X58-32A-gG	22x58	32A	10un.	1,20€
SL-CP22X58-40A-gG	22x58	40A	10un.	1,20€
SL-CP22X58-50A-gG	22x58	50A	10un.	1,20€
SL-CP22X58-63A-gG	22x58	63A	10un.	1,20€
SL-CP22X58-80A-gG	22x58	80A	10un.	1,20€
SL-CP22X58-100A-gG	22x58	100A	10un.	1,20€
SL-CP22X58-125A-gG	22x58	125A	10un.	1,20€

Bases Porta-Fusíveis F-N Cilíndricos

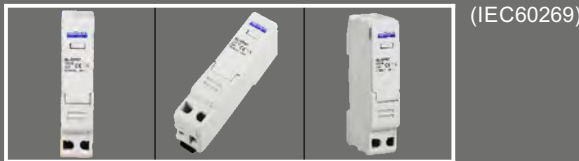

Código	Descrição	Nº Pol.	Tipo Fusível	Emb.	P.U.€
SL-CP07501	Base Porta- Fusível 1P+N	10x38	12/192		



Código	Descrição	Nº Pol.	Tipo Fusível	Emb.	P.U.€
SL-CP07201	Base Porta- Fusível	1P	14x51	12/192	6,70€
SL-CP07202	Base Porta- Fusível	2P	14x51	6/96	14,40€
SL-CP07203	Base Porta- Fusível	3P	14x51	4/64	20,00€

Fusíveis Cilíndricos (IEC60269)

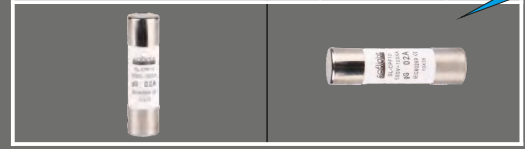

Código	Fusível	Int.(A)	Emb.	P.U.€
SL-CP10X38-02A-AM	10x38	2A	10un.	0,28€
SL-CP10X38-04A-AM	10x38	4A	10un.	0,28€
SL-CP10X38-06A-AM	10x38	6A	10un.	0,28€
SL-CP10X38-08A-AM	10x38	8A	10un.	0,28€
SL-CP10X38-10A-AM	10x38	10A	10un.	0,28€
SL-CP10X38-12A-AM	10x38	12A	10un.	0,28€
SL-CP10X38-16A-AM	10x38	16A	10un.	0,28€
SL-CP10X38-20A-AM	10x38	20A	10un.	0,28€
SL-CP10X38-25A-AM	10x38	25A	10un.	0,28€
SL-CP10X38-32A-AM	10x38	32A	10un.	0,28€

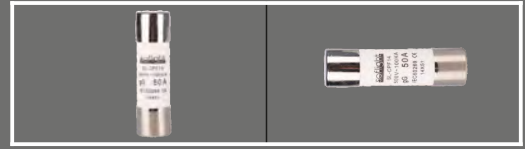

Código	Fusível	Int.(A)	Emb.	P.U.€
SL-CP14X51-10A-AM	14x51	10A	10un.	0,75€
SL-CP14X51-12A-AM	14x51	12A	10un.	0,75€
SL-CP14X51-16A-AM	14x51	16A	10un.	0,75€
SL-CP14X51-20A-AM	14x51	20A	10un.	0,75€
SL-CP14X51-25A-AM	14x51	25A	10un.	0,75€
SL-CP14X51-32A-AM	14x51	32A	10un.	0,75€
SL-CP14X51-40A-AM	14x51	40A	10un.	0,75€
SL-CP14X51-50A-AM	14x51	50A	10un.	0,75€
SL-CP14X51-63A-AM	14x51	63A	10un.	0,75€



Código	Fusível	Int.(A)	Emb.	P.U.€
SL-CP22X58-10A-AM	22x58	10A	10un.	1,20€
SL-CP22X58-16A-AM	22x58	16A	10un.	1,20€
SL-CP22X58-20A-AM	22x58	20A	10un.	1,20€
SL-CP22X58-25A-AM	22x58	25A	10un.	1,20€
SL-CP22X58-32A-AM	22x58	32A	10un.	1,20€
SL-CP22X58-40A-AM	22x58	40A	10un.	1,20€
SL-CP22X58-50A-AM	22x58	50A	10un.	1,20€
SL-CP22X58-63A-AM	22x58	63A	10un.	1,20€
SL-CP22X58-80A-AM	22x58	80A	10un.	1,20€
SL-CP22X58-100A-AM	22x58	100A	10un.	1,20€
SL-CP22X58-125A-AM	22x58	125A	10un.	1,20€

Bases Porta-Fusíveis Cilíndricos

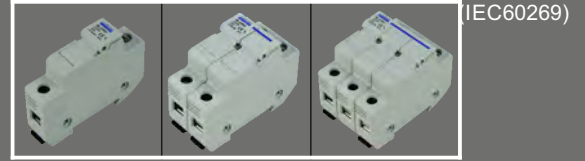

Código	Descrição	Nº Pol.	Tipo Fusível	Emb.	P.U.€
SL-CP07101	Base Porta- Fusível	1P	10x38	12/192	2,25€
SL-CP07102	Base Porta- Fusível	2P	10x38	6/96	5,15€
SL-CP07103	Base Porta- Fusível	3P	10x38	6/64	7,40€



Código	Descrição	Nº Pol.	Tipo Fusível	Emb.	P.U.€
SL-CP07301	Base Porta- Fusível	1P	22x58	12/192	11,50€
SL-CP07302	Base Porta- Fusível	2P	22x58	6/96	23,50€
SL-CP07303	Base Porta- Fusível	3P	22x58	4/64	28,60€



Código	Dimensões (mm)	NºMod.	Emb.	P.U.€
SL-CP51004	112(L)x199(A)x95(P)	4	1/30	8,70€



Código	Dimensões (mm)	NºMod.	Emb.	P.U.€
SL-CP51008	183(L)x199(A)x95(P)	8	1/30	13,10€



Código	Dimensões (mm)	NºMod.	Emb.	P.U.€
SL-CP51012	255(L)x199(A)x95(P)	12	1/30	18,90€



Código	Dimensões (mm)	NºMod.	Emb.	P.U.€
SL-CP51018	362(L)x220(A)x99(P)	18	1/10	25,50€



Código	Dimensões (mm)	NºMod.	Emb.	P.U.€
SL-CP51024	255(L)x327(A)x119(P)	24	1/10	28,60€

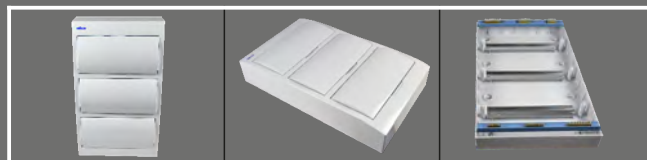

Código	Dimensões (mm)	NºMod.	Emb.	P.U.€
SL-CP51036	255(L)x500(A)x119(P)	36	1/5	46,60€

Quadros Distribuição Embutir

(IEC 60439)



Código	Dimensões (mm)	NºMod.	Emb.	P.U.€
SL-CP52004	136(L)x221(A)x34(P) Dimens.Caixa (mm) 123(L)x208(A)x56(P)	4	1/30	8,70€

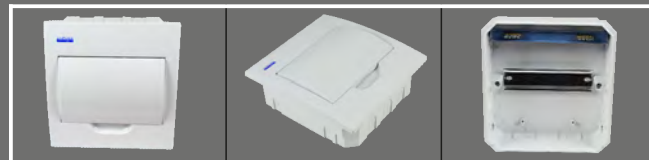

Código	Dimensões (mm)	NºMod.	Emb.	P.U.€
SL-CP52008	207(L)x221(A)x34(P) Dimens.Caixa (mm) 195(L)x208(A)x56(P)	8	1/30	12,00€



Código	Dimensões (mm)	NºMod.	Emb.	P.U.€
SL-CP52012	278(L)x221(A)x34(P) Dimens.Caixa (mm) 266(L)x208(A)x56(P)	12	1/30	17,40€



Código	Dimensões (mm)	NºMod.	Emb.	P.U.€
SL-CP52018	397(L)x251(A)x34(P) Dimens.Caixa (mm) 384(L)x238(A)x66(P)	18	1/10	25,30€

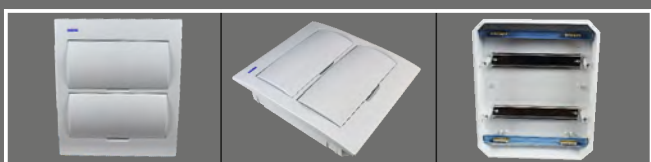

Código	Dimensões (mm)	NºMod.	Emb.	P.U.€
SL-CP52024	300(L)x345(A)x34(P) Dimens.Caixa (mm) 288(L)x333(A)x66(P)	24	1/10	41,50€



Código	Dimensões (mm)	NºMod.	Emb.	P.U.€
SL-CP52036	300(L)x500(A)x34(P) Dimens.Caixa (mm) 288(L)x488(A)x66(P)	36	1/5	47,20€

soflight®

Electric

Quadros Salientes IP 65 (EN 50022)



Código	Dimensões (mm)	NºMod.	Emb.	P.U.€
SL-CP53004	L140xA256xP100	4	1/20	17,30€

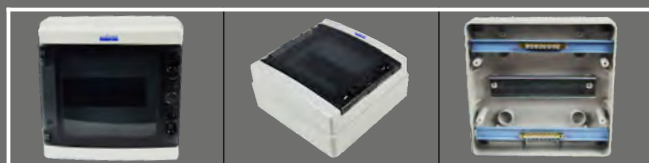

Código	Dimensões	NºMod.	Emb.	P.U.€
SL-CP53008	L212xA256xP100	8	1/20	26,60€



Código	Dimensões	NºMod.	Emb.	P.U.€
SL-CP53012	L295xA256xP140	12	1/10	38,20€



Código	Dimensões	NºMod.	Emb.	P.U.€
SL-CP53018	L410xA283xP140	18	1/5	58,70€



Código	Dimensões	NºMod.	Emb.	P.U.€
SL-CP53024	L296xA283xP140	24	1/5	76,50€

Quadros salientes



Código	Dimensões	NºMod.	Emb.	P.U.€
SL-CP50002	L50xA130xP60	2	240	2,95€



Código	Dimensões	NºMod.	Emb.	P.U.€
SL-CP50004	L85xA130xP60	4	100	4,00€

Quadros

Pentes Ligação Ponteira c/1 Metro

Código	Descrição	Tipo	Int.(A)	NºPolos	Emb.	P.U.€
SL-CP58001	Pente 1P Ponteira	63A	63A	1	100	7,40€

SL-CP58002	Pente 2P Ponteira	63A	63A	2	50	20,50€
------------	-------------------	-----	-----	---	----	--------

SL-CP58DPN	Pente FN Ponteira	63A	63A	1P+N	50	26,80€
------------	-------------------	-----	-----	------	----	--------

SL-CP58003	Pente 3P Ponteira	63A	63A	3	50	21,25€
------------	-------------------	-----	-----	---	----	--------

SL-CP58004	Pente 4P Ponteira	63A	63A	4	50	42,10€
------------	-------------------	-----	-----	---	----	--------

Pentes Ligação Forquilha c/1 Metro

Código	Descrição	Tipo	Int.(A)	NºPol.	Emb.	P.U.€
SL-CP59001	Pente 1P Forquilha	63A	63A	1	100	8,80€

SL-CP59002	Pente 2P Forquilha	63A	63A	2	100	21,90€
------------	--------------------	-----	-----	---	-----	--------

SL-CP59003	Pente 3P Forquilha	63A	63A	3	25	22,70€
------------	--------------------	-----	-----	---	----	--------

SL-CP59004-63A	Pente 4 P Forquilha	63A	63A	4	25	39,80€
----------------	---------------------	-----	-----	---	----	--------

SL-CP59004	Pente 4 P Forquilha	80A	80A	4	25	45,00€
------------	---------------------	-----	-----	---	----	--------

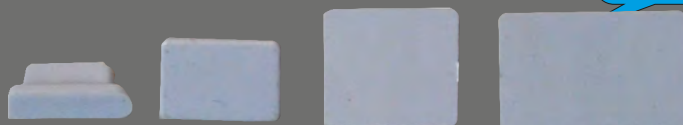
Topos para Pentes de Ligação Novos Podutos

Código	Descrição	Embal.	P.U.€
SL-CP58T01	Topo p/SL-CP58001/SL-CP59001	200/20	0,26€
SL-CP58T02	Topo p/SL-CP58002/SL-CP59002	200/20	0,29€
SL-CP58T03	Topo p/SL-CP58003/SL-CP59003	200/20	0,37€
SL-CP58T04	Topo p/SL-CP58004/SL-CP59004	200/20	0,47€

Código	Dimensões	Emb.	P.U.€
SL-CP58050	Conector de Polos p/Cabos	20/1000	1,90€



Botões em Plástico Diâm. 22mm

Botão Pressão Plástico

(EN60947-5-1)



Código	Cor	Contacto	Embalagem	P.U.€
SL-CPB01-AA11	Branco	1NO	200/20	3,35€
SL-CPB01-AA21	Preto	1NO	200/20	3,35€
SL-CPB01-AA31	Verde	1NO	200/20	3,35€
SL-CPB01-AA42	Vermelho	1NC	200/20	3,35€
SL-CPB01-AA51	Amarelo	1NO	200/20	3,35€
SL-CPB01-AA61	Azul	1NO	200/20	3,35€

Botão Pressão Plástico Saliente

(EN60947-5-1)



Código	Cor	Contacto	Embalagem	P.U.€
SL-CPB01-EL21	Preto	1NO	200/20	3,65€
SL-CPB01-EL31	Verde	1NO	200/20	3,65€
SL-CPB01-EL51	Amarelo	1NO	200/20	3,65€
SL-CPB01-EL42	Vermelho	1NC	200/20	3,65€

Botão Pres.Plástico Luminoso 24Vac

(EN60947-5-1)



Código	Cor	Contacto	Embalagem	P.U.€
SL-CPB01-AW3161-024	Branco	1NO	200/20	6,00€
SL-CPB01-AW3361-024	Verde	1NO	200/20	6,00€
SL-CPB01-AW3462-024	Vermelho	1NC	200/20	6,00€
SL-CPB01-AW3561-024	Amarelo	1NO	200/20	6,00€
SL-CPB01-AW3661-024	Azul	1NO	200/20	6,00€

Botão Pres.Plástico Luminoso 230Vac

(EN60947-5-1)



Código	Cor	Contacto	Embalagem	P.U.€
SL-CPB01-AW3161-230	Branco	1NO	200/20	6,00€
SL-CPB01-AW3361-230	Verde	1NO	200/20	6,00€
SL-CPB01-AW3462-230	Vermelho	1NC	200/20	6,00€
SL-CPB01-AW3561-230	Amarelo	1NO	200/20	6,00€
SL-CPB01-AW3661-230	Azul	1NO	200/20	6,00€

Selector Plástico Luminoso 24Vac

(EN60947-5-1)



Código	Descrição	Tensão	Cor	Cont.	P.U.€
SL-CPB01-BK2365-024	2 Pos.Fixas	24V	BR	1NO	9,50€
SL-CPB01-BK2465-024	2 Pos.Fixas	24V	AM	1NO	9,50€
SL-CPB01-BK2565-024	2 Pos.Fixas	24V	AZ	1NO	9,50€
SL-CPB01-BK2665-024	2 Pos.Fixas	24V	VD	1NO	9,50€
SL-CPB01-BK2765-024	2 Pos.Fixas	24V	VM	1NC	9,50€

Selector Plástico Luminoso 230Vac

(EN60947-5-1)



Código	Descrição	Tensão	Cor	Cont.	P.U.€
SL-CPB01-BK2365-230	2 Pos.Fixas	230V	BR	1NO	9,50€
SL-CPB01-BK2465-230	2 Pos.Fixas	230V	AM	1NO	9,50€
SL-CPB01-BK2565-230	2 Pos.Fixas	230V	AZ	1NO	9,50€
SL-CPB01-BK2665-230	2 Pos.Fixas	230V	VD	1NO	9,50€
SL-CPB01-BK2765-230	2 Pos.Fixas	230V	VM	1NC	9,50€

Seleto Plástico Manípulo Curto

(EN60947-5-1)



Código	Descrição	Contacto	Embal.	P.U.€
SL-CPB01-AD21	2 Posições Fixas	1NO	200/20	4,50€ ^{a)}
SL-CPB01-AD41	2 Pos. c/Retorno	1NO	200/20	4,85€ ^{b)}

Seleto Plástico Manípulo Curto

(EN60947-5-1)



Código	Descrição	Contacto	Embal.	P.U.€
SL-CPB01-AD33	3 Posições Fixas	2NO	200/20	4,85€ ^{a)}
SL-CPB01-AD53	3 Pos. c/Retorno	2NO	200/20	5,50€ ^{b)}

Seletor Plástico com Chave

(EN60947-5-1)



Código	Descrição	Contacto	Embalagem	P.U.€
SL-CPB01-AG21	2 Posições Fixas	1NO	200/20	7,00€

Botão Cogum.Plást.s/Encravamento

(EN60947-5-1)



Código	Cor	Contacto	Embalagem	P.U.€
SL-CPB01-AC21	Preto	1NO	200/20	4,00€
SL-CPB01-AC31	Verde	1NO	200/20	4,00€
SL-CPB01-AC42	Vermelho	1NC	200/20	4,00€



Código	Descrição	Contacto	Embalagem	P.U.€
SL-CPB01-ZBE101	Contacto Auxiliar	1NO	200/20	1,50€
SL-CPB01-ZBE102	Contacto Auxiliar	1NC	200/20	1,50€

Botão Pressão Plástico Duplo

(EN60947-5-1)



Código	Cor	Contacto	Embalagem	P.U.€
SL-CPB01-AL8325	VM/VD	1NO+1NC	200/20	7,70€

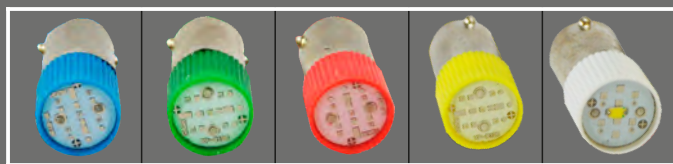

Código	Descrição	Casq.	Tensão	Cor	P.U.€
SL-CPB01-BA9S024V-BL	Lâmp. Led	BA9S	24V	AZ	3,30€
SL-CPB01-BA9S024V-GR	Lâmp. Led	BA9S	24V	VD	3,30€
SL-CPB01-BA9S024V-RD	Lâmp. Led	BA9S	24V	VM	3,30€
SL-CPB01-BA9S024V-WH	Lâmp. Led	BA9S	24V	BR	3,30€
SL-CPB01-BA9S024V-YE	Lâmp. Led	BA9S	24V	AM	3,30€
Código	Descrição	Casq.	Tensão	Cor	P.U.€
SL-CPB01-BA9S048V-BL	Lâmp. Led	BA9S	48V	AZ	3,30€
SL-CPB01-BA9S048V-GR	Lâmp. Led	BA9S	48V	VD	3,30€
SL-CPB01-BA9S048V-RD	Lâmp. Led	BA9S	48V	VM	3,30€
SL-CPB01-BA9S048V-WH	Lâmp. Led	BA9S	48V	BR	3,30€
SL-CPB01-BA9S048V-YE	Lâmp. Led	BA9S	48V	AM	3,30€

Seletor Plástico com Chave

(EN60947-5-1)



Código	Descrição	Contacto	Embalagem	P.U.€
SL-CPB01-AG33	3 Posições Fixas	1NO	200/20	9,70€

Botão Cog.Plástico c/Encrav. Rotativo

(EN60947-5-1)



Código	Cor	Contacto	Embalagem	P.U.€
SL-CPB01-AS542	Vermelho	1NC	200/20	4,90€

Botão Cog.Plás.c/Encravam.C/Chave

(EN60947-5-1)



Código	Cor	Contacto	Embalagem	P.U.€
SL-CPB01-AS142	Vermelho	1NC	200/20	6,70€

Botão Plástico Duplo Luminoso

(EN60947-5-1) **Disponível no 2º Trimestre**



Código	Cor	Contacto	Embalagem	P.U.€
SL-CPB01BW8465-024	VD/VM	1NO+1NC	200/20	9,50€
SL-CPB01BW8466-230	VD/VM	1NO+1NC	200/20	9,50€



Código	Descrição	Casq.	Tensão	Cor	P.U.€
SL-CPB01-BA9S110V-BL	Lâmp. Led	BA9S	110V	AZ	3,30€
SL-CPB01-BA9S110V-GR	Lâmp. Led	BA9S	110V	VD	3,30€
SL-CPB01-BA9S110V-RD	Lâmp. Led	BA9S	110V	VM	3,30€
SL-CPB01-BA9S110V-WH	Lâmp. Led	BA9S	110V	BR	3,30€
SL-CPB01-BA9S110V-YE	Lâmp. Led	BA9S	110V	AM	3,30€
Código	Descrição	Casq.	Tensão	Cor	P.U.€
SL-CPB01-BA9S230V-BL	Lâmp. Led	BA9S	230V	AZ	3,30€
SL-CPB01-BA9S230V-GR	Lâmp. Led	BA9S	230V	VD	3,30€
SL-CPB01-BA9S230V-RD	Lâmp. Led	BA9S	230V	VM	3,30€
SL-CPB01-BA9S230V-WH	Lâmp. Led	BA9S	230V	BR	3,30€
SL-CPB01-BA9S230V-YE	Lâmp. Led	BA9S	230V	AM	3,30€

Sinalizadores Compactos

soflight®

(EN60947-5-1)

Electric

Sinalizador Compacto Ø 22mm Led



Código	Cor	Tensão	Emb.	P.U.€
SL-CPB01-22DS-GR-024	Verde	24V	500/20	2,50€
SL-CPB01-22DS-RD-024	Vermelho	24V	500/20	2,50€
SL-CPB01-22DS-YE-024	Amarelo	24V	500/20	2,50€
SL-CPB01-22DS-BL-024	Azul	24V	500/20	2,50€
SL-CPB01-22DS-WH-024	Branco	24V	500/20	2,50€



Código	Cor	Tensão	Emb.	P.U.€
SL-CPB01-22DS-GR-230	Verde	230V	500/20	2,50€
SL-CPB01-22DS-RD-230	Vermelho	230V	500/20	2,50€
SL-CPB01-22DS-YE-230	Amarelo	230V	500/20	2,50€
SL-CPB01-22DS-BL-230	Azul	230V	500/20	2,50€
SL-CPB01-22DS-WH-230	Branco	230V	500/20	2,50€

Besouro Ø 22mm Led Sem Flash

(EN60947-5-1)



Código	Descrição	Tensão	Emb.	P.U.€
SL-CPB01-22FM-024	Besouro s/Flash	24V	500/20	5,50€
SL-CPB01-22FM-230	Besouro s/Flash	230V	500/20	5,50€

Besouro Ø 22mm Led com Flash

(EN60947-5-1)



Código	Descrição	Tensão	Emb.	P.U.€
SL-CPB01-22SM-024	Besouro c/Flash	24V	500/20	6,10€
SL-CPB01-22SM-230	Besouro c/Flash	230V	500/20	6,10€

Chave para Botões Ø 22mm



Novos Podutos

Código	Descrição	Emb.	P.U.€
SL-CPB01-CH01	Chave para Botão 22mm	500/20	2,25€



Novos Podutos

Código	Descrição	Emb.	P.U.€
SL-CPB01-CH02	Chave para Botão 22mm	500/20	0,70€

Sinalizador Ø 22mm Duplo Led



Código	Cor	Tensão	Emb.	P.U.€
SL-CPB01-127-RG-024	Vermelho/Verde	24V	500/20	6,85€
SL-CPB01-127-RG-230	Vermelho/Verde	230V	500/20	6,85€

Etiqueta para Botões Ø 22mm

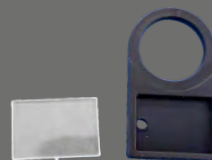

Novos Podutos

Código	Descrição	Emb.	P.U.€
SL-CPB01-F10	Etiqueta para Botão 22mm	500/20	0,25€

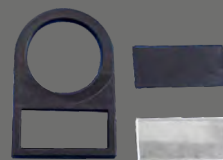

Novos Podutos

Código	Descrição	Emb.	P.U.€
SL-CPB01-F11	Etiqueta para Botão 22mm	500/20	0,35€

Caixa Plástico Vazia para SL-CPB01



Código	Descrição	Nº Furos	Emb.	P.U.€
SL-CPB01-CXB-01	Caixa Vazia	1	100	3,90€
SL-CPB01-CXB-02	Caixa Vazia	2	100	5,15€
SL-CPB01-CXB-03	Caixa Vazia	3	100	7,10€
SL-CPB01-CXB-04	Caixa Vazia	4	100	10,10€

Caixa Plástico Vazia para SL-CPB01



Código	Descrição	Nº Furos	Emb.	P.U.€
SL-CPB01-CXB-01Y	Caixa Vazia	1	100	3,90€
SL-CPB01-CXB-02Y	Caixa Vazia	2	100	5,15€
SL-CPB01-CXB-03Y	Caixa Vazia	3	100	7,00€
SL-CPB01-CXB-04Y	Caixa Vazia	4	100	10,10€

Caixa Plástico com 1 Botão

(EN60947-5-1)



Código	Descrição	Contacto	Embal.	P.U.€
SL-CPB01-CXB101H29	Botão Start	1NO	100	8,70€

Caixa Plástico com 2 Botões

(EN60947-5-1)



Código	Descrição	Contacto	Embal.	P.U.€
SL-CPB01-CXB211H29	Start/Stop	1NO+1NC	100	11,50€



Código	Descrição	Contacto	Embal.	P.U.€
SL-CPB01-CXB111H29	Botão Stop	1NC	100	8,70€

Caixa Plástico c/2 Botões + Sinaliz.

(EN60947-5-1)



Código	Descrição	Contacto	Embal.	P.U.€
SL-CPB01-CXB132H29	Start/Stop	1NO+1NC	100	11,50€

Caixa Plástico c/Emerg. s/Encravamento

(EN60947-5-1)



Código	Descrição	Contacto	Embal.	P.U.€
SL-CPB01-CXB116	Botão Emerg.	1NC	100	8,70€

Caixa Plástico c/Emerg. c/Encravam.

(EN60947-5-1)



Código	Descrição	Contacto	Embal.	P.U.€
SL-CPB01-CXBJ174	Botão Emerg.	1NC	100	8,70€

Caixa Plástico c/Emerg. c/Chave

(EN60947-5-1)



Código	Descrição	Contacto	Embal.	P.U.€
SL-CPB01-CXBJ178	Emerg.com Chave	1C	100	8,70€



Código	Descrição	Contacto	Embal.	P.U.€
SL-CPB01-CXB142H29	Pos.c/Chave	1NO	100	12,00€

Caixa Plástico c/Selector

(EN60947-5-1)



Código	Descrição	Contacto	Embal.	P.U.€
SL-CPB01-CXB361H29	Seletor 2 Pos.	1NO	100	12,00€

Botões Metálicos

Botão Pressão Metálico (EN60947-5-1)

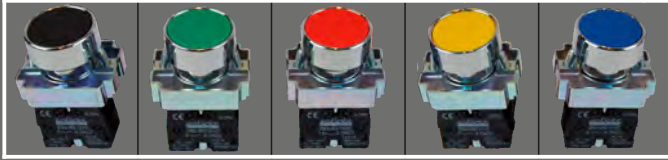

Código	Cor	Contacto	Embal.	P.U.€
SL-CPB02-BA21	Preto	1NO	200/20	3,15€
SL-CPB02-BA31	Verde	1NO	200/20	3,15€
SL-CPB02-BA42	Vermelho	1NC	200/20	3,15€
SL-CPB02-BA51	Amarelo	1NO	200/20	3,15€
SL-CPB02-BA61	Azul	1NO	200/20	3,15€

Sinalizadores Metálicos

(EN60947-5-1)

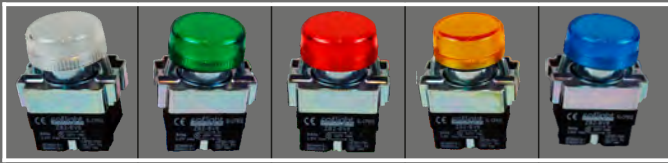

Código	Cor	Tensão	Embal.	P.U.€
SL-CPB02-BV61-024	Branco	24V	200/20	3,40€
SL-CPB02-BV63-024	Verde	24V	200/20	3,40€
SL-CPB02-BV64-024	Vermelho	24V	200/20	3,40€
SL-CPB02-BV65-024	Amarelo	24V	200/20	3,40€
SL-CPB02-BV66-024	Azul	24V	200/20	3,40€

Código	Cor	Tensão	Embal.	P.U.€
SL-CPB02-BV61-230	Branco	230V	200/20	3,40€
SL-CPB02-BV63-230	Verde	230V	200/20	3,40€
SL-CPB02-BV64-230	Vermelho	230V	200/20	3,40€
SL-CPB02-BV65-230	Amarelo	230V	200/20	3,40€
SL-CPB02-BV66-230	Azul	230V	200/20	3,40€

Seletor Metálico Manípulo Curto

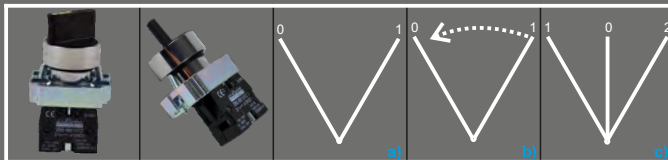

Código	Descrição	Contacto	Embal.	P.U.€
SL-CPB02-BD21	2 Pos. Fixa	1NO	200/20	4,85€ a)

Código	Descrição	Contacto	Embal.	P.U.€
SL-CPB02-BD41	2 Pos. C/Ret.	1NO	200/20	4,85€ b)

Código	Descrição	Contacto	Embal.	P.U.€
SL-CPB02-BD33	3 Pos. Fixas	2NO	200/20	5,35€ c)

Seletor Metálico com Chave

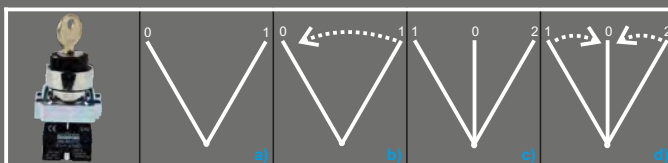

Código	Descrição	Contacto	Embal.	P.U.€
SL-CPB02-BG21	2 Pos. Fixas	1NO	200/20	5,95€ a)

Código	Descrição	Contacto	Embal.	P.U.€
SL-CPB02-BG41	2 Pos. C/Retorno	1NO	200/20	6,10€ b)

Código	Descrição	Contacto	Embal.	P.U.€
SL-CPB02-BG33	3 Pos. Fixas	2NO	200/20	7,50€ c)

Código	Descrição	Contacto	Embal.	P.U.€
SL-CPB02-BG53	3 Pos. C/Retorno	2NO	200/20	7,85€ d)

Botão Pres.Met. Prot. Borr. (EN60947-5-1)

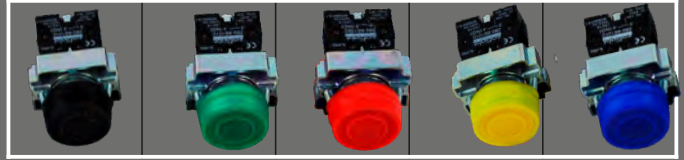

Código	Cor	Contacto	Embal.	P.U.€
SL-CPB02-BP21	Preto	1NO	200/20	3,40€
SL-CPB02-BP31	Verde	1NO	200/20	3,40€
SL-CPB02-BP42	Vermelho	1NC	200/20	3,40€
SL-CPB02-BP51	Amarelo	1NO	200/20	3,40€
SL-CPB02-BP61	Azul	1NO	200/20	3,40€

Botão Cog.Met.s/Encravam.40mm

(EN60947-5-1)

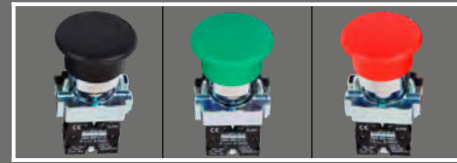

Código	Cor	Contacto	Embal.	P.U.€
SL-CPB02-BC21	Preto	1NO	200/20	3,75€
SL-CPB02-BC31	Verde	1NO	200/20	3,75€
SL-CPB02-BC42	Vermelho	1NC	200/20	3,75€

Botão Cogum.Met.C/Encravam.40mm

(EN60947-5-1)



Código	Cor	Contacto	Embal.	P.U.€
SL-CPB02-BS542	Vermelho	1NC	200/20	4,00€

Botão Cog.Met.C/Encravam.30mm

(EN60947-5-1)

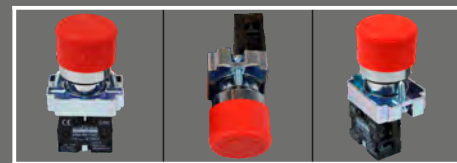

Código	Cor	Contacto	Embal.	P.U.€
SL-CPB02-BS442	Vermelho	1NC	200/20	4,00€

Botão Cogum. Met. c/Chave 40mm

(EN60947-5-1)

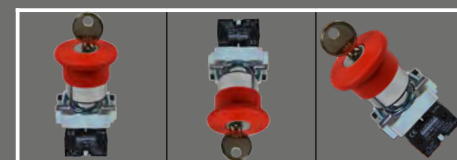

Código	Cor	Contacto	Embal.	P.U.€
SL-CPB02-BS142	Vermelho	1NC	200/20	8,95€

Botões / Relés Estado Sólido

Manípulo Metálico 22mm

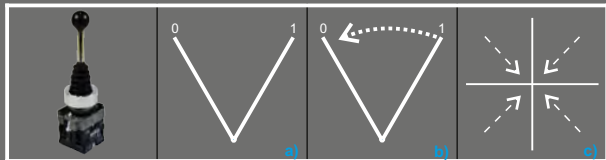

Manípulo Metálico 30mm

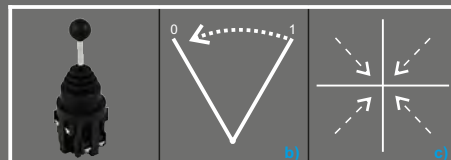

Código	Descrição	Contacto	Embalagem	P.U.€
SL-CPB02-PA12	2 Posições Fixas	2NO	200/10	10,30€ ^{a)}
SL-CPB02-PA22	2 Pos.c/retorno	2NO	200/10	12,00€ ^{b)}
SL-CPB02-PA24	4 Pos.c/retorno	4NO	200/10	13,90€ ^{c)}

Código	Descrição	Contacto	Embalagem	P.U.€
SL-CPB02-C201	2 Pos. c/Retorno	2NO	200/10	21,60€ ^{a)}
SL-CPB02-C402	4 Pos. c/Retorno	4NO	200/10	26,50€ ^{b)}

Botão Pressão Duplo Metálico



Contactos para Botões



Código	Cor	Contacto	Embalagem	P.U.€
SL-CPB02-BL8325	VM/VD	1NO+1NC	200/20	8,60€

Código	Descrição	Contacto	Embalagem	P.U.€
SL-CPB02-BE101	Contacto	NO	100	1,70€ ^{a)}
SL-CPB02-BE102	Contacto	NC	100	1,70€ ^{b)}
SL-CPB02-BZ101	Contacto+Base	NO	50	2,00€ ^{c)}
SL-CPB02-BZ102	Contacto+Base	NC	50	2,00€ ^{d)}

Relés de Estado Sólido Monofásicos



- * LED Indicador de Estado
- * Tempo de Intervenção ≤ 10 ms
- * Control de Intensidade ≤ 12 mA
- * Dimensões: L58xA44xP30mm



Código	Input	Output	Fases	Int.(A)	P.U.€
SL-CP241-310A	80-250Vac	90-480Vac	1	10A	18,80€
SL-CP241-325A	80-250Vac	90-480Vac	1	25A	23,90€
SL-CP241-340A	80-250Vac	90-480Vac	1	40A	25,90€
SL-CP241-360A	80-250Vac	90-480Vac	1	60A	38,00€
SL-CP241-380A	80-250Vac	90-480Vac	1	80A	51,55€

Código	Input	Output	Fases	Int.(A)	P.U.€
SL-CP241-310B	3-32Vdc	90-480Vac	1	10A	18,80€
SL-CP241-325B	3-32Vdc	90-480Vac	1	25A	23,90€
SL-CP241-340B	3-32Vdc	90-480Vac	1	40A	25,90€
SL-CP241-360B	3-32Vdc	90-480Vac	1	60A	38,00€
SL-CP241-380B	3-32Vdc	90-480Vac	1	80A	47,25€

Relés de Estado Sólido Trifásicos



- * LED Indicador de Estado
- * Tempo de Intervenção ≤ 10 ms
- * Control de Intensidade ≤ 12 mA
- * Dimensões: L105x74x40mm



Código	Input	Output	Fases	Int.(A)	P.U.€
SL-CP243B320A	80-250Vac	90-480Vac	3	20A	75,20€
SL-CP243B340A	80-250Vac	90-480Vac	3	40A	95,00€

Código	Input	Output	Fases	Int.(A)	P.U.€
SL-CP243B320B	3-32Vdc	90-480Vac	3	20A	63,90€
SL-CP243B340B	3-32Vdc	90-480Vac	3	40A	75,70€

Dissipadores p/Relé Estado Sólido



Código	Descrição	P.U.€
SL-CP24DIS-1X40A	D dissipador para Relé 1 Fase 10-40A	6,65€
SL-CP24DIS-1X80A	D dissipador para 1 Fase 60-80A	14,50€
SL-CP24DIS-3X40A	D dissipador para 3 Fases 10-40A	29,80€

Interruptor de Manobra (Acionamento Central) : Seccionadores (EN60947-3)

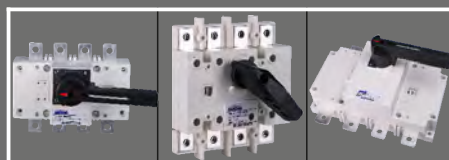

Código	Polos	AC-21 400V (A)	Potência AC3/400V/KW	Emb.	P.U.€
SL-CP683100	3P	100A	55kW	1/10	45,80€
SL-CP683160	3P	160A	80kW	1/10	68,80€
SL-CP683250	3P	250A	100kW	1/8	100,40€
SL-CP683400	3P	400A	220kW	1	240,00€
SL-CP683630	3P	630A	315kW	1	295,50€
SL-CP6831000	3P	1000A	560kW	1	863,90€
SL-CP6831250	3P	1250A	560kW	1	950,20€

Código	Polos	AC-21 A	Potência AC3/400V/KW	Emb.	P.U.€
SL-CP684100	4P	100A	55kW	1/10	47,00€
SL-CP684160	4P	160A	80kW	1/10	80,80€
SL-CP684250	4P	250A	100kW	1/8	127,00€
SL-CP684400	4P	400A	220kW	1	280,30€
SL-CP684630	4P	630A	315kW	1	360,00€
SL-CP6841000	4P	1000A	560kW	1	1170,00€
SL-CP6841250	4P	1250A	560kW	1	2010,00€

Manípulos para Interruptores



Código	Descrição	Emb.	P.U.€
SL-CP68MAN-100	Manípulo para Int. 63-100A	1	17,90€
SL-CP68MAN-630	Manípulo para Int. 160-630A	1	33,60€
SL-CP68MAN-3150	Manípulo para Int. 800-3150A	1	52,90€

Calha DIN

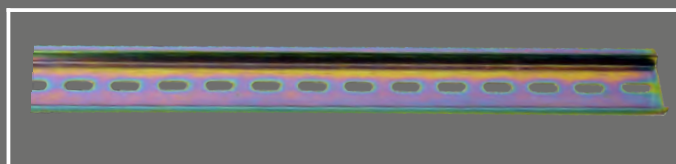

Código	Descrição	Embalagem	P.U.€
SL-CP60001	Calha DIN (1 Metro)	20/100	2,60€

Bloco Repartidor Unipolar 80 a 500A



Código	Ent.	Capacidade (mm2)	Emb.	P.U.€
SL-CP-BR-80A	1x16	4x6+2x16	1/200	7,15€ a)
SL-CP-BR-125A	1x35+1x16	6x16	1/100	14,90€ b)
SL-CP-BR-160A	1x70+1x16	6x16	1/100	15,40€ c)
SL-CP-BR-250A	1x120	2x35+5x16+4x10	1/50	38,40€ d)
SL-CP-BR-400A	1x185	2x35+5x16+4x10	1/50	41,80€ e)
SL-CP-BR-500A	1x185	2x35+5x16+4x10	1/50	44,00€ f)

Repartidor de Escada

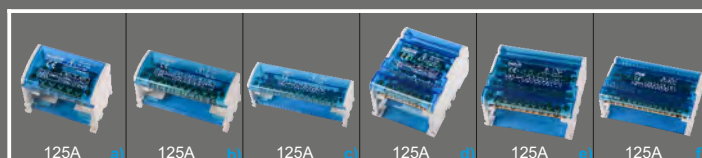

Código	Polos	Capacidade	Embalagem	P.U.€
SL-CP-RE-2X7	2X7	4X25+10X16	2/200	8,30€ a)
SL-CP-RE-2X11	2X11	4X35+4X25+14X16	1/120	11,30€ b)
SL-CP-RE-2X15	2X15	4X35+4X25+22X16	1/100	14,90€ c)
SL-CP-RE-4X7	4X7	8X35+20X16	1/100	15,70€ d)
SL-CP-RE-4X11	4X11	8X35+8X25+28X16	1/60	21,80€ e)
SL-CP-RE-4X15	4X15	8X35+8X25+44X16	1/50	28,50€ f)

Repartidor de Escada

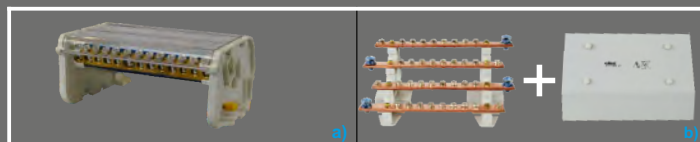

Código	Amperes	Embalagem	P.U.€
SL-CP-RE-4X13-160A	160A	2/200	58,00€ a)
SL-CP-RE-4X11-200A	200A	1/120	90,00€ b)
SL-CP-RE-4X11-250A	250A	1/100	130,00€ c)
SL-CP-RE-4X10-400A	400A	1/100	175,00€ d)

Microswitch 125,250,380V - 15A

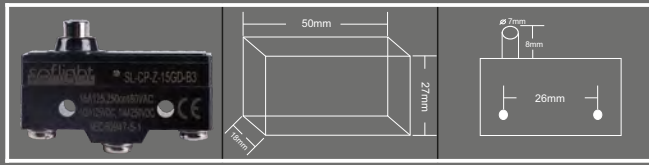

Código	Descrição	Embalagem	P.U.€
SL-CP-Z-15GD-B3	Microswitch	200/20	4,25€

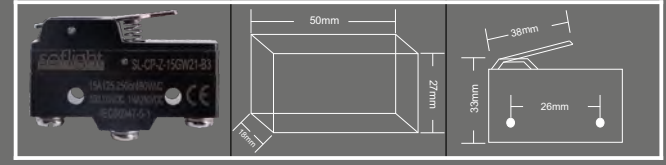

Código	Descrição	Embalagem	P.U.€
SL-CP-Z-15GW21-B3	Microswitch	200/20	5,15€

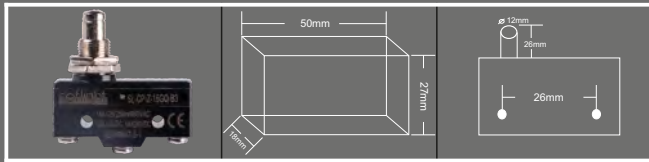

Código	Descrição	Embalagem	P.U.€
SL-CP-Z-15GQ-B3	Microswitch	200/20	5,40€

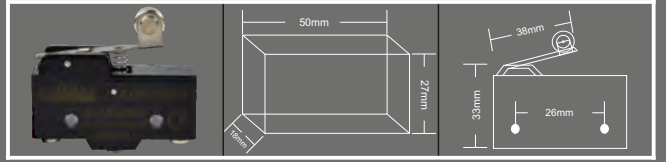

Código	Descrição	Embalagem	P.U.€
SL-CP-Z-15GW22S-B3	Microswitch	200/20	5,40€

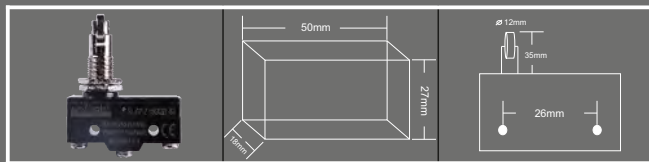

Código	Descrição	Embalagem	P.U.€
SL-CP-Z-15GQ21-B3	Microswitch	200/20	5,40€

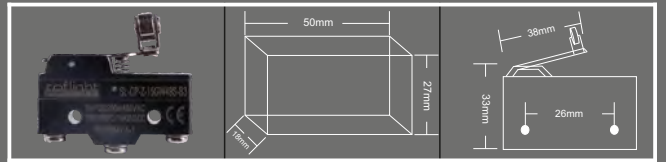

Código	Descrição	Embalagem	P.U.€
SL-CP-Z-15GW49S-B3	Microswitch	200/20	5,40€

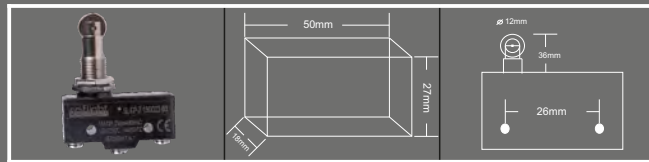

Código	Descrição	Embalagem	P.U.€
SL-CP-Z-15GQ22-B3	Microswitch	200/20	5,40€

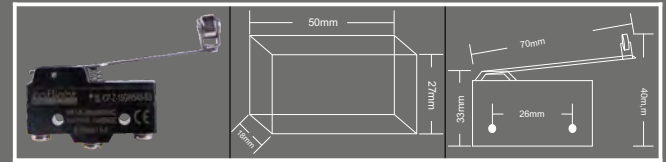

Código	Descrição	Embalagem	P.U.€
SL-CP-Z-15GW54S-B3	Microswitch	200/20	5,40€

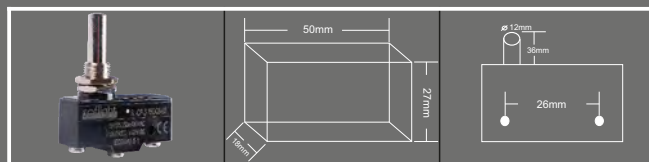

Código	Descrição	Embalagem	P.U.€
SL-CP-Z-15GQ8-B3	Microswitch	200/20	5,65€

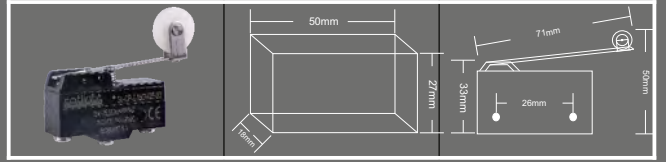

Código	Descrição	Embalagem	P.U.€
SL-CP-Z-15GW25-B3	Microswitch	200/20	5,80€

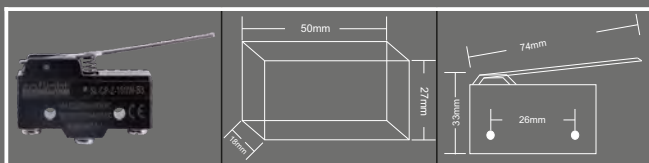

Código	Descrição	Embalagem	P.U.€
SL-CP-Z-15GW-B3	Microswitch	200/20	5,10€

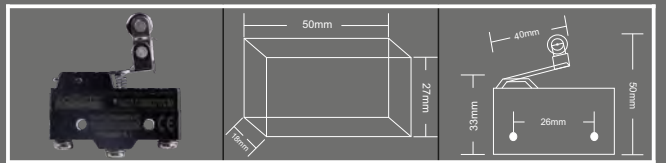

Código	Descrição	Embalagem	P.U.€
SL-CP-Z-15GW227S-B3	Microswitch	200/20	5,50€

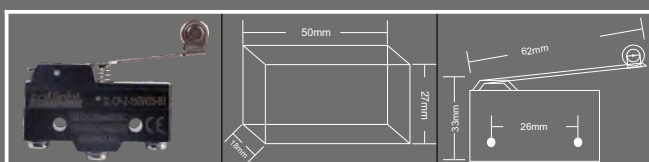

Código	Descrição	Embalagem	P.U.€
SL-CP-Z-15GW2S-B3	Microswitch	200/20	5,40€

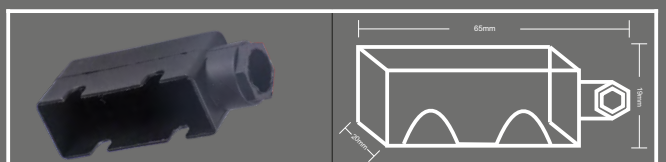

Código	Descrição	Embalagem	P.U.€
SL-CP-AP-B	Tampa para Microswitch	200/20	1,35€

Fins de Curso Metálicos

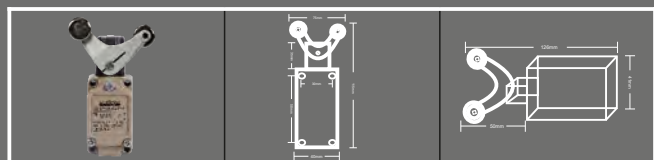

Código	Descrição	Embalagem	P.U.€
SL-CP-WL-CA32-41	Fim de Curso	200/20	24,50€

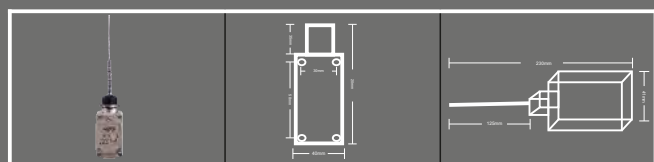

Código	Descrição	Embalagem	P.U.€
SL-CP-WL-NJ-S2	Fim de Curso	200/20	20,15€

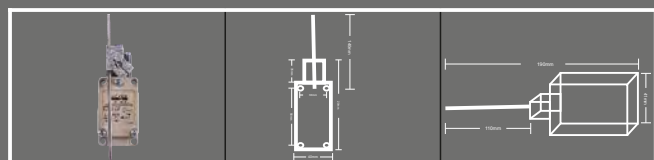

Código	Descrição	Embalagem	P.U.€
SL-CP-WL-CL	Fim de Curso	200/20	20,15€

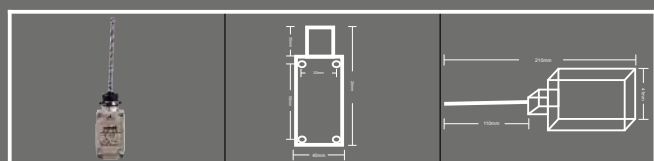

Código	Descrição	Embalagem	P.U.€
SL-CP-WL-NJ	Fim de Curso	200/20	20,15€

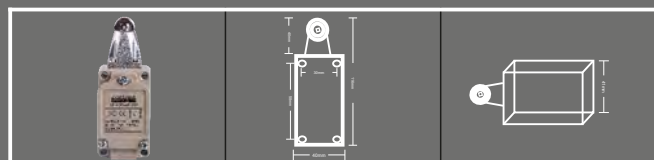

Código	Descrição	Embalagem	P.U.€
SL-CP-WL-D2	Fim de Curso	200/20	20,15€

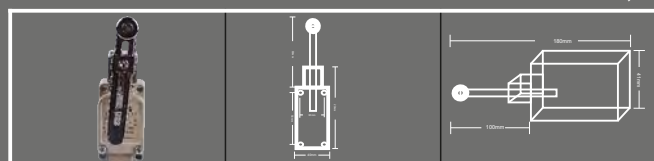

Código	Descrição	Embalagem	P.U.€
SL-CP-WL-CA12-2	Fim de Curso	200/20	20,15€

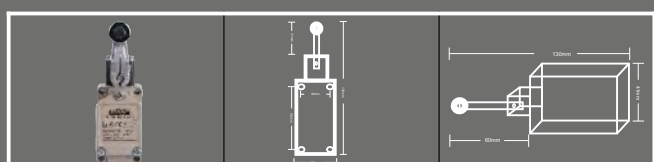

Código	Descrição	Embalagem	P.U.€
SL-CP-WL-CA2-2	Fim de Curso	200/20	20,15€

Fins de Curso em Plástico

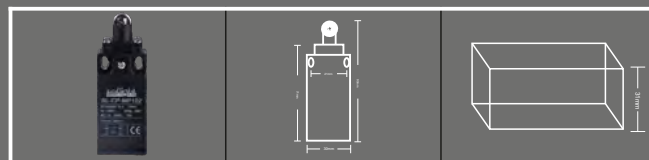

Código	Descrição	Embalagem	P.U.€
SL-CP-MP-102	Fim de Curso	200/20	12,40€

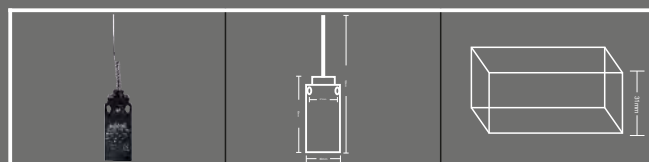

Código	Descrição	Embalagem	P.U.€
SL-CP-MP-106	Fim de Curso	200/20	12,40€

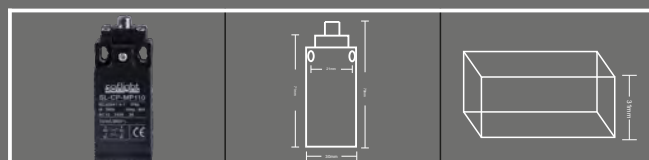

Código	Descrição	Embalagem	P.U.€
SL-CP-MP-110	Fim de Curso	200/20	12,40€

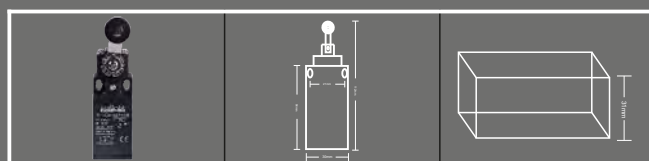

Código	Descrição	Embalagem	P.U.€
SL-CP-MP-118	Fim de Curso	200/20	12,40€

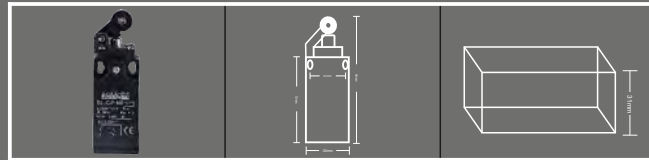

Código	Descrição	Embalagem	P.U.€
SL-CP-MP-121	Fim de Curso	200/20	12,40€

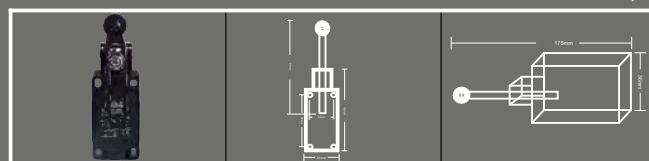

Código	Descrição	Embalagem	P.U.€
SL-CP-MS-141	Fim de Curso	200/20	12,40€

Fins de Curso Metálicos

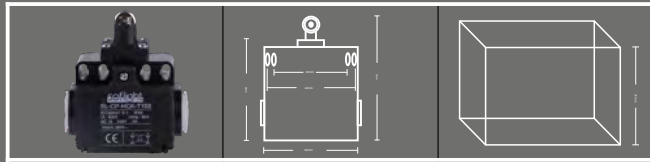

Código	Descrição	Embalagem	P.U.€
SL-CP-HCK-T102	Fim de Curso	200/20	13,50€

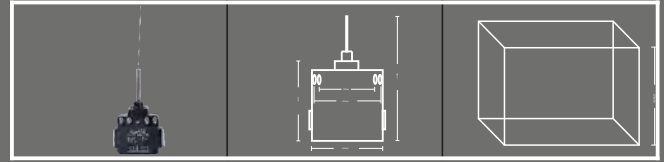

Código	Descrição	Embalagem	P.U.€
SL-CP-HCK-T106	Fim de Curso	200/20	13,50€

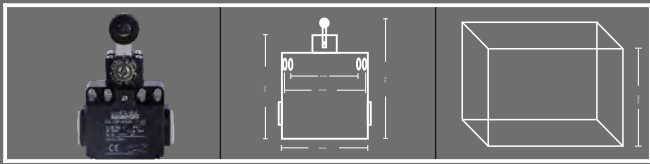

Código	Descrição	Embalagem	P.U.€
SL-CP-HCK-T118	Fim de Curso	200/20	13,50€

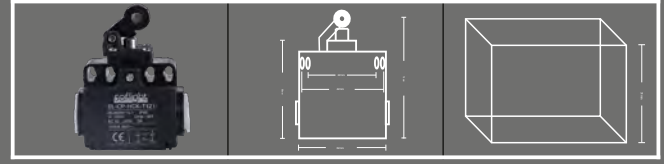

Código	Descrição	Embalagem	P.U.€
SL-CP-HCK-T121	Fim de Curso	200/20	13,50€

Interruptor Emergência, Montagem Painel (EN60947-3)

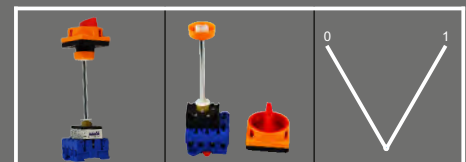
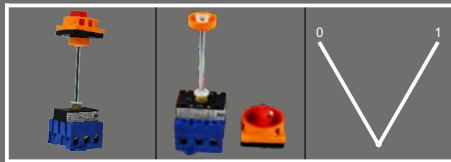

Código	Polos	AC-21A A	Potência AC3/400V/KW	Emb.	P.U.€
SL-CP65-325	3P	25A	5,5	25	26,50€
SL-CP65-332	3P	32A	7,5	25	34,70€
SL-CP65-340	3P	40A	11	25	47,00€
SL-CP65-363	3P	63A	12,5	25	53,50€
SL-CP65-3100	3P	100A	30	20	68,80€

Código	Polos	AC-21A A	Potência AC3/400V/KW	Emb.	P.U.€
SL-CP65-425	4P	25A	5,5	25	34,80€
SL-CP65-432	4P	32A	7,5	25	45,60€
SL-CP65-440	4P	40A	11	25	49,70€
SL-CP65-463	4P	63A	12,5	25	59,50€
SL-CP65-4100	4P	100A	30	20	85,70€

Interruptor Seccionador Com Caixa IP 65 (EN60947-3)

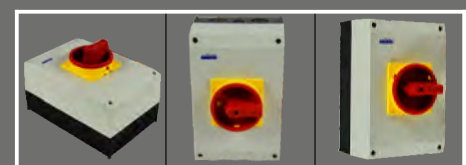
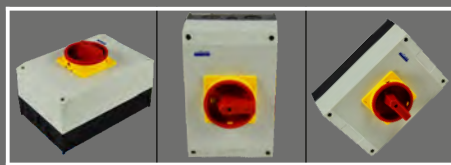

Código	Polos	AC-21A A	Potência AC3/400V/KW	Emb.	P.U.€
SL-CP66-332	3P	32A	7,5	30	42,20€
SL-CP66-363	3P	63A	12,5	20	65,80€
SL-CP66-3100	3P	100A	30	10	148,00€

Código	Polos	AC-21A A	Potência AC3/400V/KW	Emb.	P.U.€
SL-CP66-432	4P	32A	7,5	30	44,80€
SL-CP66-463	4P	63A	12,5	20	99,90€
SL-CP66-4100	4P	100A	30	10	155,00€

Interruptor Emergência, Montagem Painel (EN60947-3)

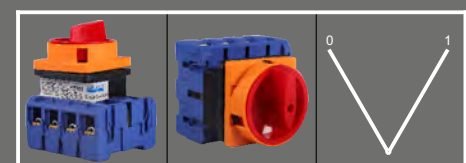

Código	Polos	AC-21A A	Potência AC3/400V/KW	Emb.	P.U.€
SL-CP67-325	3P	25A	5,5	25	26,60€
SL-CP67-340	3P	40A	11	25	42,20€
SL-CP67-363	3P	63A	12,5	25	45,80€
SL-CP67-3100	3P	100A	30	20	67,90€

Código	Polos	AC-21A A	Potência AC3/400V/KW	Emb.	P.U.€
SL-CP67-425	4P	25A	5,5	25	32,50€
SL-CP67-440	4P	40A	11	25	48,30€
SL-CP67-463	4P	63A	12,5	25	55,90€
SL-CP67-4100	4P	100A	30	20	82,00€

Pimenteiros

Pimenteiro



Constituído por:
6 Tom.Schuko
6 Disj.1P 16A

Código	Alimentação	IP	P.U.€
PIM-01010	Cabo direto a Caixa (S/Cabo)	44	140,00€



Constituído por:
1 Tom.CEE 5x16A
1 Tom.CEE 3x16A
2 Tom.Schuko
1 Disj.3P 32A
3 Disj.1P 16A

Código	Alimentação	IP	P.U.€
PIM-01020	Cabo direto a Caixa (S/Cabo)	44	125,00€

Pimenteiro



Constituído por:
1 Tom.CEE 3x16A
1 Tom.CEE 5x16A
1 Tom.CEE 5x32A
3 Tom.Schuko
1 I.Dif.4x40A 30mA
1 Disj.3P 32A
1 Disj.3P 16A
2 Disj.1P 16A
1 Sinal.Triplo

Código	Alimentação	IP	P.U.€
PIM-01030	Cabo direto a Caixa (S/Cabo)	44	320,00€



Constituído por:
3 T.CEE 3x16A
1 T.CEE 5x16A
1 T.CEE 5x32A
2 Tom.Schuko
1 I.Dif.4x40A
1 Disj.3P 32A
1 Disj.3P 16A
2 Disj.1P 16A

Código	Alimentação	IP	P.U.€
PIM-02010	Tomada CEE Macho 5x32A	44	322,00€

Pimenteiro



Constituído por:
3 Tom.CEE 3x16A
3 Tom.CEE 5x16A
1 Tom.CEE 5x32A
2 Tom.Schuko
1 I.Dif.4x40A 30mA
1 Disj.3P 32A
1 Disj.3P 16A
2 Disj.1P 16A

Código	Alimentação	IP	P.U.€
PIM-03010	Tomada CEE Macho 5x32A	67	425,00€

Caixa Vazia para Pimenteiro

Novos Podutos



Código	Descrição	P.U.€
PIM-CX01030	Caixa Vazia para Pimenteiro	85,00€

Caixa Vazia ABS



Código	Altura	Largura	Profundidade	Nº Módulos	P.U.€
SL-07-110	260mm	150mm	120mm	6	16,00€

Caixa Vazia ABS



Código	Altura	Largura	Profundidade	Nº Módulos	P.U.€
SL-07-220	288mm	218mm	124mm	10	23,50€

Caixa Vazia ABS



Código	Altura	Largura	Profundidade	Nº Módulos	P.U.€
SL-07-330	288mm	280mm	130mm	12	31,00€

Novos Podutos



Caixa Vazia Pimenteiro

Código	Descrição	P.U.€
PIM-CX-02010	Caixa Vazia para Pimenteiro	72,00€

Ponteiras Isoladas



Código	Descrição	Comp.	Cor	Embal.	Preço 100Unid.
SL-T-E0508	Ponteira 0,50mm	8mm	●	100	1,15€
SL-T-E05.12	Ponteira 0,50mm	12mm	●	100	1,55€
SL-T-E7508	Ponteira 0,75mm	8mm	●	100	1,15€
SL-T-E75.12	Ponteira 0,75mm	12mm	●	100	1,55€
SL-T-E1008	Ponteira 1,00mm	8mm	●	100	1,15€
SL-T-E10.12	Ponteira 1,00mm	12mm	●	100	1,55€
SL-T-E1508	Ponteira 1,50mm	8mm	●	100	1,25€
SL-T-E15.18	Ponteira 1,50mm	18mm	●	100	2,60€
SL-T-E2508	Ponteira 2,50mm	8mm	●	100	1,65€
SL-T-E25.18	Ponteira 2,50mm	18mm	●	100	3,00€
SL-T-E4009	Ponteira 4,00mm	9mm	●	100	2,50€
SL-T-E40.18	Ponteira 4,00mm	18mm	●	100	4,30€
SL-T-E6010	Ponteira 6,00mm	10mm	●	100	3,25€
SL-T-E60.18	Ponteira 6,00mm	18mm	●	100	5,75€
SL-T-E1012	Ponteira 10,00mm	12mm	●	100	4,35€
SL-T-E10.18	Ponteira 10,00mm	18mm	●	100	7,00€
SL-T-E1612	Ponteira 16,00mm	12mm	●	100	6,00€
SL-T-E16.18	Ponteira 16,00mm	18mm	●	100	9,60€
SL-T-E2516	Ponteira 25,00mm	16mm	●	100	11,40€
SL-T-E25.22	Ponteira 25,00mm	22mm	●	100	15,60€
SL-T-E3516	Ponteira 35,00mm	16mm	●	100	13,10€
SL-T-E35.25	Ponteira 35,00mm	25mm	●	100	19,20€
SL-T-E5020	Ponteira 50,00mm	20mm	●	100	24,60€
SL-T-E7027	Ponteira 70,00mm	27mm	●	100	49,50€
SL-T-E9525	Ponteira 95,00mm	25mm	●	100	103,50€
SL-T-E12027	Ponteira 120,00mm	27mm	●	50	64,00€

Ponteiras Duplas Isoladas



Código	Descrição	Cor	Embal.	Preço 100Unid.
SL-T-TE0508	Ponteira 0,50mm	●	100	1,90€
SL-T-TE7508	Ponteira 0,75mm	●	100	1,90€
SL-T-TE1008	Ponteira 1,0mm	●	100	1,90€
SL-T-TE1508	Ponteira 1,50mm	●	100	2,75€
SL-T-TE2510	Ponteira 2,50mm	●	100	2,75€
SL-T-TE4012	Ponteira 4,00mm	●	100	5,60€
SL-T-TE6014	Ponteira 6,00mm	●	100	7,70€
SL-T-TE1014	Ponteira 10,00mm	●	100	11,50€
SL-T-TE1614	Ponteira 16,00mm	●	100	15,50€

Terminais Isolados Ponteira



Código	Descrição	Cor	Embal.	Preço 100Unid.
SL-T-PTV1,25-10	0,5-1,5mm, Pont. 10mm	●	100	4,50€
SL-T-PTV2-10	1,5-2,5mm, Pont. 10mm	●	100	4,70€
SL-T-PTV5,5-13	4,0-6,0mm, Ponteira 13mm	●	100	9,25€

Terminais Isolados Macho



Código	Descrição	Cor	Embal.	Preço 100Unid.
SL-T-MDD1,25-110	0,5-1,5mm (2,4mm)	●	100	4,80€
SL-T-MDD1,25-187	0,5-1,5mm (4,8mm)	●	100	4,80€
SL-T-MDD1,25-250	0,5-1,5mm (6,3mm)	●	100	4,80€
SL-T-MDD2-110	1,5-2,5mm (2,4mm)	●	100	4,90€
SL-T-MDD2-187	1,5-2,5mm (4,8mm)	●	100	4,90€
SL-T-MDD2-250	1,5-2,5mm (6,3mm)	●	100	4,90€
SL-T-MDD5,5-250	4,0-6,0mm (6,3mm)	●	100	7,75€

Ponteiras / Terminais

Terminais Isolados Fêmea



(Qt. Mínima Venda/Saco 100 Unid.)

Código	Descrição	Cor	Embal.	Preço 100Unid.
SL-T-FDD1,25-110	0,5-1,5mm (2,4mm)	●	100	4,50€
SL-T-FDD1,25-187	0,5-1,5mm (4,8mm)	●	100	4,50€
SL-T-FDD1,25-250	0,5-1,5mm (6,3mm)	●	100	4,50€
SL-T-FDD2-110	1,5-2,5mm (2,4mm)	●	100	4,90€
SL-T-FDD2-187	1,5-2,5mm (4,8mm)	●	100	4,90€
SL-T-FDD2-250	1,5-2,5mm (6,3mm)	●	100	4,90€
SL-T-FDD5,5-250	4,0-6,0mm (6,3mm)	●	100	6,55€

Terminais Isolados M/F



(Qt. Mínima Venda/Saco 100 Unid.)

Código	Descrição	Cor	Embal.	Preço 100Unid.
SL-T-PBDD1,25-250	0,5-1,5mm (6,3mm)	●	100	9,00€
SL-T-PBDD2-250	1,5-2,5mm (6,3mm)	●	100	10,00€

Term.Totalmente Isol. Fêmea



(Qt. Mínima Venda/Saco 100 Unid.)

Código	Descrição	Cor	Embal.	Preço 100Unid.
SL-T-FDFD1,25-110	0,5-1,5mm (2,4mm)	●	100	6,90€
SL-T-FDFD1,25-187	0,5-1,5mm (4,8mm)	●	100	6,90€
SL-T-FDFD1,25-250	0,5-1,5mm (6,3mm)	●	100	6,90€
SL-T-FDFD2-110	0,5-2,5mm (2,4mm)	●	100	7,70€
SL-T-FDFD2-187	0,5-2,5mm (4,8mm)	●	100	7,70€
SL-T-FDFD2-250	0,5-2,5mm (6,3mm)	●	100	7,70€
SL-T-FDFD5,5-250	4,0-6,0mm (6,3mm)	●	100	10,70€

Terminais Isolados Forquilha



(Qt. Mínima Venda/Saco 100 Unid.)

Código	Descrição	Cor	Embal.	Preço 100Unid.
SL-T-SVS1,25-4	0,5-1,5mm, Furo 4,3mm	●	100	4,15€
SL-T-SVS1,25-5	0,5-1,5mm, Furo 5,3mm	●	100	4,80€
SL-T-SVS1,25-6	0,5-1,5mm, Furo 6,4mm	●	100	5,00€
SL-T-SVS2-4	1,5-2,5mm, Furo 4,3mm	●	100	5,05€
SL-T-SVS2-5	1,5-2,5mm, Furo 5,3mm	●	100	5,15€
SL-T-SVS2-6	1,5-2,5mm, Furo 6,4mm	●	100	5,35€
SL-T-SVS5,5-4	4,0-6,0mm, Furo 4,3mm	●	100	8,50€
SL-T-SVS5,5-6	4,0-6,0mm, Furo 6,4mm	●	100	9,40€
SL-T-SVS5,5-8	4,0-6,0mm, Furo 8,4mm	●	100	11,40€

Terminais Isolados de Olhal



(Qt. Mínima Venda/Saco 100 Unid.)

Código	Descrição	Cor	Embal.	Preço 100Unid.
SL-T-RVS1,25-4	0,5-1,5mm, Furo 4,3mm	●	100	4,05€
SL-T-RVS1,25-5	0,5-1,5mm, Furo 5,3mm	●	100	4,05€
SL-T-RVS1,25-6	0,5-1,5mm, Furo 6,4mm	●	100	5,50€
SL-T-RVS2-4	1,5-2,5mm, Furo 4,3mm	●	100	3,86€
SL-T-RVS2-5	1,5-2,5mm, Furo 5,3mm	●	100	5,10€
SL-T-RVS2-6	1,5-2,5mm, Furo 6,4mm	●	100	5,70€
SL-T-RVS5,5-4	4,0-6,0mm, Furo 4,3mm	●	100	8,50€
SL-T-RVS5,5-6	4,0-6,0mm, Furo 6,4mm	●	100	9,40€
SL-T-RVS5,5-8	4,0-6,0mm, Furo 8,4mm	●	100	11,40€

Terminais Isolados União



(Qt. Mínima Venda/Saco 100 Unid.)

Código	Descrição	Cor	Embal.	Preço 100Unid.
SL-T-BV1,25	0,5-1,5mm	●	100	5,10€
SL-T-BV2	0,5-2,5mm	●	100	5,80€
SL-T-BV5,5	4,0-6,0mm	●	100	8,50€

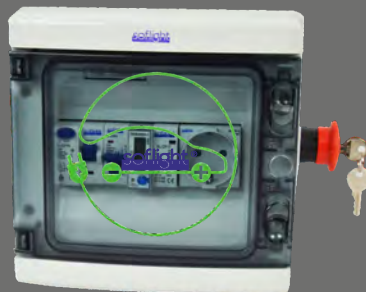

Quadro Mobilidade Eléct. Monofásico, 16A(3,5Kw) Sem Contador Energia

Constituído por:

Interruptor Diferencial Monofásico [Tipo A](#)

Disjuntor Unipolar
Contactor Modular
Tomada Schuko Modular
Botoneira Emergência com Chave

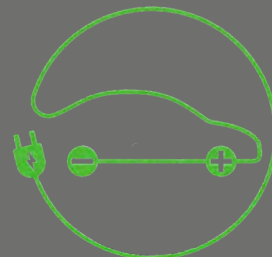

Adequado para Carregadores Portateis

Código	P.U.€
Codigo: QE-QMEM-01-16A	190,00€

Quadro Mobilidade Eléct. Monofásico, 16A(3,5Kw) Com Contador Energia

Constituído por:

Interruptor Diferencial Monofásico [Tipo A](#)

Contador Energia Modular Monofásico Modbus RS 485
Disjuntor Unipolar
Contactor Modular
Tomada Schuko Modular
Botoneira Emergência com Chave

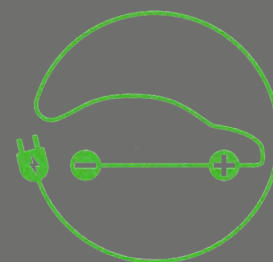

Adequado para Carregadores Portateis

Código	P.U.€
Codigo: QE-QMEM-02-16A	215,00€

Quadro Mobilidade Eléct. Monofásico, 32A(7,4Kw) Sem Contador Energia

Constituído por:

Interruptor Diferencial Monofásico [Tipo A](#)

Disjuntor Unipolar
Contactor Modular
Botoneira Emergência com Chave

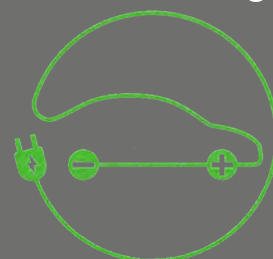

Adequado para Wall Box Monofásicas até 7,4KW

Código	P.U.€
Codigo: QE-QMEM-03-32ADIFA	205,00€

Quadro Mobilidade Eléct. Monofásico, 32A(7,4Kw) Com Contador Energia

Constituído por:

Interruptor Diferencial Monofásico [Tipo A](#)

Contador Energia Modular Monofásico Modbus RS 485
Disjuntor Unipolar
Contactor Modular
Botoneira Emergência com Chave

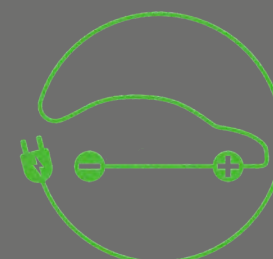

Adequado para Wall Box Monofásicas até 7,4KW

Código	P.U.€
Codigo: QE-QMEM-04-32ADIFA	270,00€

Quadro Mobilidade Eléct. Monofásico, 32A(7,4Kw) Sem Contador Energia

Constituído por:

Interruptor Diferencial Monofásico **Tipo B**

Disjuntor Unipolar

Contactor Modular

Botoneira Emergência com Chave

Código	P.U.€
Codigo: QE-QMEM-03-32A	665,00€

Adequado para Wall Box Monofásicas até 7,4KW

Quadro Mobilidade Eléct. Monofásico, 32A(7,4Kw) Com Contador Energia

Constituído por:

Interruptor Diferencial Monofásico **Tipo B**

Contador Energia Modular Monofásico Modbus RS 485

Disjuntor Unipolar

Contactor Modular

Botoneira Emergência com Chave

Código	P.U.€
Codigo: QE-QMEM-04-32A	710,00€

Adequado para Wall Box Monofásicas até 7,4KW



Quadro Mobilidade Eléctrica Trifásico, 32A(22Kw)Sem Contador Energia

Constituído por:

Interruptor Diferencial Trifásico **Tipo B**

Disjuntor Tetrapolar

Contactor Modular

Botoneira Emergência com Chave

Código	P.U.€
Codigo: QE-QMET-01-32A	985,00€

Adequado para Wall Box Trifásica até 22KW

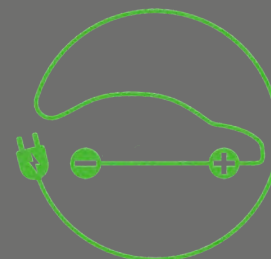

Quadro Mobilidade Eléctrica Trifásico, 32A(22KW) Com Contador Energia

Constituído por:

Interruptor Diferencial Trifásico **Tipo B**

Contador Energia Modular Trifásico Modbus RS 485

Disjuntor Tetrapolar

Contactor Modular

Botoneira Emergência com Chave

Código	P.U.€
Codigo: QE-QMET-02-32A	1100,00€

Adequado para Wall Box Trifásica até 22KW

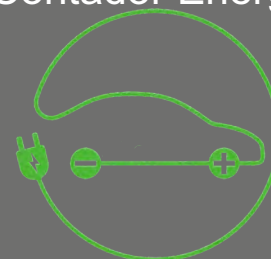

Quadro Sondas Monofásico para 1 Bomba

Com Proteção Através de Relé Térmico e Disjuntor

Contactora e Relé Térmico [soflight®](#)

Relé Nivel Para Proteção da Bomba em Caso de Falta Água [AVAL](#)

Funcionamento Automático/Desligado. comandado por um comutador 2 Posições

Proteção contra Curto-Circuitos Através de Disjuntor

Proteção contra Sobrecargas através de Relé Térmico

Indicação Motor Ligado (Sinalizador Verde)

Indicação Disparo Térmico (Sinalizador Vermelho)



Código	Monofásico	Potência		Intensidade Amperes	Relé Térmico Regulação	Contactora Tripolar	Disjuntor 4,5kA		P.U.€
		HP	KW				Nº Polos	Amp.	
QE-QSM-0254	Com Relé Térmico 2,5-4A - 230Vac	0,33-0,50	0,25-0,37	2,8-3,5	2,5-4A	12A	2	6-10	77,00€
QE-QSM-0406	Com Relé Térmico 4-6A - 230Vac	0,75-1	0,55-0,74	4,5-5,7	4-6A	12A	2	10-16	77,00€
QE-QSM-0558	Com Relé Térmico 5,5-8A - 230Vac	0,75-1	0,55-0,74	4,5-5,7	5,5-8A	12A	2	10-16	77,00€
QE-QSM-0710	Com Relé Térmico 7-10A - 230Vac	1,5	1-1,0	8,7	7-10A	12A	2	20	77,00€
QE-QSM-0913	Com Relé Térmico 9-13A - 230Vac	2	1,50	10,7	9-13A	18A	2	25	77,00€
QE-QSM-1218	Com Relé Térmico 12-18A - 230Vac	3	2,20	14,7	12-18A	18A	2	32	77,00€

Quadro Sondas Trifásico para 1 Bomba

Com Proteção Através de Relé Térmico e Disjuntor

Contactora e Relé Térmico [soflight®](#)

Relé Nivel Para Proteção da Bomba em Caso de Falta Água [AVAL](#)

Funcionamento Automático/Desligado. comandado por um comutador 2 Posições

Proteção contra Curto-Circuitos Através de Disjuntor

Proteção contra Sobrecargas através de Relé Térmico

Indicação Motor Ligado (Sinalizador Verde)

Indicação Disparo Térmico (Sinalizador Vermelho)



Código	Trifásico	Potência		Intensidade Amperes	Relé Térmico Regulação	Contactora Tripolar	Disjuntor 4,5kA		P.U.€
		HP	KW				Nº Polos	Amp.	
QE-QST-0116	Com Relé Térmico 1-1,6A - 400Vac	0,50	0,37	1,1	1-1,6A	12A	3	6	85,00€
QE-QST-01625	Com Relé Térmico 1,6-2,5A - 400Vac	0,75	0,55	1,6	1,6-2,5A	12A	3	6	85,00€
QE-QST-0254	Com Relé Térmico 2,5-4A - 400Vac	1	0,75	2,1	2,5-4A	12A	3	6	85,00€
QE-QST-0406	Com Relé Térmico 4-6A - 400Vac	1,5-2	1,1-1,5	3-3,9	4-6A	12A	3	6-10	85,00€
QE-QST-0558	Com Relé Térmico 5,5-8A - 400Vac	3	2,20	5,8	5,5-8A	12A	3	16	85,00€
QE-QST-0710	Com Relé Térmico 7-10A - 400Vac	4-5	3-3,7	7,5-6	7-10A	12A	3	16-20	85,00€
QE-QST-0913	Com Relé Térmico 9,13A - 400Vac	5,5	4	9,8	9-13A	18A	3	20	85,00€
QE-QST-1218	Com Relé Térmico 12-18A - 400Vac	7,5	5,6	13,5	12-18A	18A	3	32	85,00€

Quadro Proteção Digital, SOFLIGHT-PRO com Relé **Toscano** TMP6

- *Com proteção através de relé digital Toscano TMP6, Contacto e disjuntor 4,5kA 
- *Controlador digital TMP6 com interface intuitivo
- *Bi-Tensão 230/400Vac para Bombas Monofásicas e Trifásicas
- *Proteções: Sobrecorrente e subcorrente / Falta de Fase / Frequência Excessiva de Arranques
- *Control de Nível Mediante Sondas Condutivas (1 ou 2 sondas) ou sem sondas (subcorrente)
- *Saída para Nível Baixo (5A Máximo)
- *Saída para Alarme (5a Máximo)
- *Indicação do Numero de Arranques da Bomba e Numero de Horas de Funcionamento da Bomba
- *Intensidade de corrente máxima de 12A sem contactor / 40A com contactor
- *Ajuste Intensidade Máxima: AUTO/0,5... 40A (Disparo em 7s)
- *Ajuste Intensidade Mínima: OFF/3...240 minutos
- *Indicações: Motor Ligado / Alarme / Nível Baixo, Intensidade Máxima / Mínima, Tempo de Rearme



Código	Monofásico	Potência		Intensidade Amperes	Contactor Tripolar	Disjuntor 4,5kA Nº Polos Amp.	P.U.€
		HP	KW				
QE-QSMD01-230	Quadro Nível Digital Monofásico SOFLIGHT PRO	0,33-3	0,25-2,2	2,8-14,7	18A	2 32	152,00€

Código	Trifásico	Potência		Intensidade Amperes	Contactor Tripolar	Disjuntor 4,5kA Nº Polos Amp.	P.U.€
		HP	KW				
QE-QSTD01-400	Quadro Nível Digital Trifásico SOFLIGHT PRO	0,5-7,5	0,37-5.6	1,1-13,5	18A	3 16	160,00€

Quadro Proteção Digital com Relé **AVEL** PRObomba

- *Com proteção através de relé digital **AVEL** e disjuntor 4,5kA 
- *Controlador digital com interface intuitivo que permite:
- *Controlar/protoger bomba s/necessidade boia, através da medição de intensidade de corrente eléctrica
- *Controlar/protoger bomba para enchimento de tanques através de ligação a boia nível
- *Controlar e proteger motor eléctrico
- *Intensidade de corrente máxima de 25A
- *Determinação automática dos parâmetros de funcionamento da bomba/motor através do modo autotune ou introdução manual dos mesmos
- *Desativação automática da bomba/motor em caso de sobrecorrente (funcionamento anómalo bomba/motor) ou subcorrente (poço/furo sem água), com alerta no ecrã e com registo até 254 falhas
- *Conhecimento em tempo real do estado da bomba/*motor através do ecrã iluminado (Ligado / Desligado) intensidade de corrente eléctrica instantânea, tipo de falha (sobrecorrente, subcorrente) e contagem decrescente até nova tentativa após falha.
- *Bloqueio automático do controlador após três falhas consecutivas de sobrecorrente, sendo o tempo de espera entre falhas 5 minutos, cinco falhas consecutivas de subcorrente, sendo o tempo de espera entre falhas configurável, permitindo adaptar este controlador a diferentes furos/poços de água.
- *Versões para bombas / motores monofásicos (230Vac) e trifásicos (400Vac)

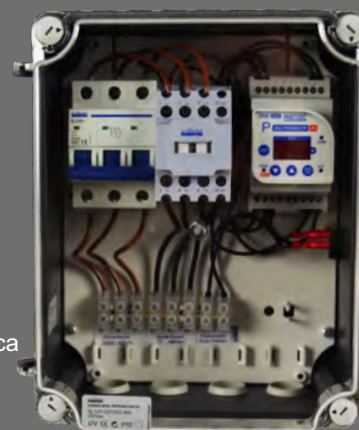

Código	Monofásico	Potência		Intensidade Amperes	Contactor Tripolar	Disjuntor 4,5kA Nº Polos Amp.	P. U.
		HP	KW				
QE-QSMD02-230	Quadro Digital Monofásico	0,33-3	0,25-2,2	2,8-14,7	18A	2 32	170,00€

Código	Trifásico	Potência		Intensidade Amperes	Contactor Tripolar	Disjuntor 4,5kA Nº Polos Amp.	P. U.
		HP	KW				
QE-QSTD02-400	Quadro Digital Trifásico	0,5-7,5	0,37-5.6	1,1-13,5	18A	3 16	185,00€

Guarda Motor para 1 Bomba

Guarda Motor Sem Disjuntor para 1 Bomba Monofásico / Trifásico

Com Proteção Através de Relé Térmico sem Disjuntor
Contactor e Relé Térmico soflight®
Funcionamento Automático/Desligado comandado por um comutador 2 Posições
Proteção contra Sobrecargas através de Relé Térmico
Indicação Motor Ligado (Sinalizador Verde)
Indicação Disparo Térmico (Sinalizador Vermelho)

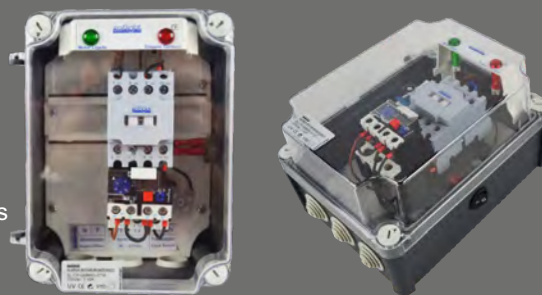

Código	Monofásico	HP	Potência KW	Intensidade Amperes	Relé Térmico Regulação	Contactor Tripolar	P.U.€
QE-GMM01-0254	C/Relé Térmico 2,5-4A - 230Vac	0,33-0,50	0,25-0,37	2,8-3,5	2,5-4A	12A	39,50€
QE-GMM01-0406	C/Relé Térmico 4-6A - 230Vac	0,75-1	0,55-0,74	4,5-5,7	4-6A	12A	39,50€
QE-GMM01-0558	C/Relé Térmico 5,5-8A - 230Vac	0,75-1	0,55-0,74	4,5-5,7	5,5-8A	12A	39,50€
QE-GMM01-0710	C/Relé Térmico 7-10A - 230Vac	1,5	1-1,0	8,7	7-10A	12A	39,50€
QE-GMM01-0913	C/Relé Térmico 9-13A - 230Vac	2	1,50	10,7	9-13A	18A	39,50€
QE-GMM01-1218	C/Relé Térmico 12-18A - 230Vac	3	2,20	14,7	12-18A	18A	39,50€

Código	Trifásico	HP	Potência KW	Intensidade Amperes	Relé Térmico Regulação	Contactor Tripolar	P.U.€
QE-GMT01-0116	C/Relé Térmico 1-1,6A - 400Vac	0,50	0,37	1,1	1-1,6A	12A	39,50€
QE-GMT01-01625	C/Relé Térmico 1,6-2,5A - 400Vac	0,75	0,55	1,6	1,6-2,5A	12A	39,50€
QE-GMT01-0254	C/Relé Térmico 2,5-4A - 400Vac	1	0,75	2,1	2,5-4A	12A	39,50€
QE-GMT01-0406	C/Relé Térmico 4-6A - 400Vac	1,5-2	1,1-1,5	3-3,9	4-6A	12A	39,50€
QE-GMT01-0558	C/Relé Térmico 5,5-8A - 400Vac	3	2,20	5,8	5,5-8A	12A	39,50€
QE-GMT01-0710	C/Relé Térmico 7-10A - 400Vac	4-5	3-3,7	7,5-6	7-10A	12A	39,50€
QE-GMT01-0913	C/Relé Térmico 9,13A - 400Vac	5,5	4	9,8	9-13A	18A	39,50€
QE-GMT01-1218	C/Relé Térmico 12-18A - 400Vac	7,5	5,6	13,5	12-18A	18A	39,50€

Guarda Motor com Disjuntor para 1 Bomba Monofásico / Trifásico

Com Proteção Através de Relé Térmico e Disjuntor 4,5kA
Contactor e Relé Térmico soflight®
Funcionamento Automático/Desligado comandado por um comutador 2 Posições
Proteção contra Curto-Circuitos Através de Disjuntor
Proteção contra Sobrecargas através de Relé Térmico
Indicação Motor Ligado (Sinalizador Verde)
Indicação Disparo Térmico (Sinalizador Vermelho)



Código	Monofásico	HP	Potência KW	Intensidade Amperes	Relé Térmico Regulação	Contactor Tripolar	Disjuntor 4,5kA Nº Polos Amp.	P.U.€
QE-GMM02-0254	C/Relé Térmico 2,5-4A - 230Vac	0,33-0,50	0,25-0,37	2,8-3,5	2,5-4A	12A	2 6-10	49,00€
QE-GMM02-0406	C/Relé Térmico 4-6A - 230Vac	0,75-1	0,55-0,74	4,5-5,7	4-6A	12A	2 10-16	49,00€
QE-GMM02-0558	C/Relé Térmico 5,5-8A - 230Vac	0,75-1	0,55-0,74	4,5-5,7	5,5-8A	12A	2 10-16	49,00€
QE-GMM02-0710	C/Relé Térmico 7-10A - 230Vac	1,5	1-1,0	8,7	7-10A	12A	2 20	49,00€
QE-GMM02-0913	C/Relé Térmico 9-13A - 230Vac	2	1,50	10,7	9-13A	18A	2 25	49,00€
QE-GMM02-1218	C/Relé Térmico 12-18A - 230Vac	3	2,20	14,7	12-18A	18A	2 32	49,00€

Código	Trifásico	HP	Potência KW	Intensidade Amperes	Relé Térmico Regulação	Contactor Tripolar	Disjuntor 4,5kA Nº Polos Amp.	P.U.€
QE-GMT02-0116	C/Relé Térmico 1-1,6A - 400Vac	0,50	0,37	1,1	1-1,6A	12A	3 6	52,00€
QE-GMT02-01625	C/Relé Térmico 1,6-2,5A - 400Vac	0,75	0,55	1,6	1,6-2,5A	12A	3 6	52,00€
QE-GMT02-0254	C/Relé Térmico 2,5-4A - 400Vac	1	0,75	2,1	2,5-4A	12A	3 6	52,00€
QE-GMT02-0406	C/Relé Térmico 4-6A - 400Vac	1,5-2	1,1-1,5	3-3,9	4-6A	12A	3 6-10	52,00€
QE-GMT02-0558	C/Relé Térmico 5,5-8A - 400Vac	3	2,20	5,8	5,5-8A	12A	3 16	52,00€
QE-GMT02-0710	C/Relé Térmico 7-10A - 400Vac	4-5	3-3,7	7,5-6	7-10A	12A	3 16-20	52,00€
QE-GMT02-0913	C/Relé Térmico 9,13A - 400Vac	5,5	4	9,8	9-13A	18A	3 20	52,00€
QE-GMT02-1218	C/Relé Térmico 12-18A - 400Vac	7,5	5,6	13,5	12-18A	18A	3 32	52,00€

Quadro Alternância Monofásico para 2 Bombas

Com Proteção Através de Relé Térmico sem Disjuntor

Contactora e Relé Térmico 

Funcionamento Automático/Desligado comandado por um comutador 2 Posições

Proteção contra Sobrecargas através de Relé Térmico

Indicação Motor Ligado (Sinalizador Verde)

Indicação Disparo Térmico (Sinalizador Vermelho)



Código	Monofásico	HP	Potência KW	Intensidade Amperes	Relé Térmico Regulação	Contactora Tripolar	P.U.€
QE-QA2BM01-0116	C/Relé Térmico 1-1,6A - 230Vac	0,50	0,37	1,1	1-1,6A	12A	255,00€
QE-QA2BM01-01625	C/Relé Térmico 1,6-2,5A - 230Vac	0,75	0,55	1,6	1,6-2,5A	12A	255,00€
QE-QA2BM01-0254	C/Relé Térmico 2,5-4A - 230Vac	1	0,75	2,1	2,5-4A	12A	255,00€
QE-QA2BM01-0406	C/Relé Térmico 4-6A - 230Vac	1,5-2	1,1-1,5	3-3,9	4-6A	12A	255,00€
QE-QA2BM01-0558	C/Relé Térmico 5,5-8A - 230Vac	3	2,20	5,8	5,5-8A	12A	255,00€
QE-QA2BM01-0710	C/Relé Térmico 7-10A - 230Vac	4-5	3-3,7	7,5-6	7-10A	12A	255,00€
QE-QA2BM01-0913	C/Relé Térmico 9,13A - 230Vac	5,5	4	9,8	9-13A	18A	255,00€
QE-QA2BM01-1218	C/Relé Térmico 12-18A - 230Vac	7,5	5,6	13,5	12-18A	18A	255,00€

Quadro Alternância Monofásico para 2 Bombas, para sondas Nível

Com Proteção Através de Relé Térmico sem Disjuntor

Contactora e Relé Térmico 

Funcionamento Automático/Desligado comandado por um comutador 2 Posições

Proteção contra Sobrecargas através de Relé Térmico

Indicação Motor Ligado (Sinalizador Verde)

Indicação Disparo Térmico (Sinalizador Vermelho)



Código	Monofásico	HP	Potência KW	Intensidade Amperes	Relé Térmico Regulação	Contactora Tripolar	P.U.€
QE-QA2BM02-0116	C/Relé Térmico 1-1,6A - 230Vac	0,50	0,37	1,1	1-1,6A	12A	280,00€
QE-QA2BM02-01625	C/Relé Térmico 1,6-2,5A - 230Vac	0,75	0,55	1,6	1,6-2,5A	12A	280,00€
QE-QA2BM02-0254	C/Relé Térmico 2,5-4A - 230Vac	1	0,75	2,1	2,5-4A	12A	280,00€
QE-QA2BM02-0406	C/Relé Térmico 4-6A - 230Vac	1,5-2	1,1-1,5	3-3,9	4-6A	12A	280,00€
QE-QA2BM02-0558	C/Relé Térmico 5,5-8A - 230Vac	3	2,20	5,8	5,5-8A	12A	280,00€
QE-QA2BM02-0710	C/Relé Térmico 7-10A - 230Vac	4-5	3-3,7	7,5-6	7-10A	12A	280,00€
QE-QA2BM02-0913	C/Relé Térmico 9,13A - 230Vac	5,5	4	9,8	9-13A	18A	280,00€
QE-QA2BM02-1218	C/Relé Térmico 12-18A - 230Vac	7,5	5,6	13,5	12-18A	18A	280,00€

Quadro Alternância Trifásico para 2 Bombas

Com Proteção Através de Relé Térmico sem Disjuntor

Contactora e Relé Térmico 

Funcionamento Automático/Desligado comandado por um comutador 2 Posições

Proteção contra Sobrecargas através de Relé Térmico

Indicação Motor Ligado (Sinalizador Verde)

Indicação Disparo Térmico (Sinalizador Vermelho)



Código	Trifásico	HP	Potência KW	Intensidade Amperes	Relé Térmico Regulação	Contactora Tripolar	P.U.€
QE-QA2BT01-0116	C/Relé Térmico 1-1,6A - 400Vac	0,50	0,37	1,1	1-1,6A	12A	262,00€
QE-QA2BT01-01625	C/Relé Térmico 1,6-2,5A - 400Vac	0,75	0,55	1,6	1,6-2,5A	12A	262,00€
QE-QA2BT01-0254	C/Relé Térmico 2,5-4A - 400Vac	1	0,75	2,1	2,5-4A	12A	262,00€
QE-QA2BT01-0406	C/Relé Térmico 4-6A - 400Vac	1,5-2	1,1-1,5	3-3,9	4-6A	12A	262,00€
QE-QA2BT01-0558	C/Relé Térmico 5,5-8A - 400Vac	3	2,20	5,8	5,5-8A	12A	262,00€
QE-QA2BT01-0710	C/Relé Térmico 7-10A - 400Vac	4-5	3-3,7	7,5-6	7-10A	12A	262,00€
QE-QA2BT01-0913	C/Relé Térmico 9,13A - 400Vac	5,5	4	9,8	9-13A	18A	262,00€
QE-QA2BT01-1218	C/Relé Térmico 12-18A - 400Vac	7,5	5,6	13,5	12-18A	18A	262,00€

Quadro Alternância Trifásico para 2 Bombas, para sondas Nível

Com Proteção Através de Relé Térmico sem Disjuntor

Contactora e Relé Térmico 

Funcionamento Automático/Desligado comandado por um comutador 2 Posições

Proteção contra Sobrecargas através de Relé Térmico

Indicação Motor Ligado (Sinalizador Verde)

Indicação Disparo Térmico (Sinalizador Vermelho)



Código	Trifásico	HP	Potência KW	Intensidade Amperes	Relé Térmico Regulação	Contactora Tripolar	P.U.€
QE-QA2BT02-0116	C/Relé Térmico 1-1,6A - 400Vac	0,50	0,37	1,1	1-1,6A	12A	290,00€
QE-QA2BT02-01625	C/Relé Térmico 1,6-2,5A - 400Vac	0,75	0,55	1,6	1,6-2,5A	12A	290,00€
QE-QA2BT02-0254	C/Relé Térmico 2,5-4A - 400Vac	1	0,75	2,1	2,5-4A	12A	290,00€
QE-QA2BT02-0406	C/Relé Térmico 4-6A - 400Vac	1,5-2	1,1-1,5	3-3,9	4-6A	12A	290,00€
QE-QA2BT02-0558	C/Relé Térmico 5,5-8A - 400Vac	3	2,20	5,8	5,5-8A	12A	290,00€
QE-QA2BT02-0710	C/Relé Térmico 7-10A - 400Vac	4-5	3-3,7	7,5-6	7-10A	12A	290,00€
QE-QA2BT02-0913	C/Relé Térmico 9,13A - 400Vac	5,5	4	9,8	9-13A	18A	290,00€
QE-QA2BT02-1218	C/Relé Térmico 12-18A - 400Vac	7,5	5,6	13,5	12-18A	18A	290,00€

Quadro Alternância Monofásico para 3 Bombas

Com Proteção Através de Relé Térmico sem Disjuntor

Contactora e Relé Térmico 

Funcionamento Automático/Desligado comandado por um comutador 2 Posições

Proteção contra Sobrecargas através de Relé Térmico

Indicação Motor Ligado (Sinalizador Verde)

Indicação Disparo Térmico (Sinalizador Vermelho)



Código	Monofásico	HP	Potência KW	Intensidade Amperes	Relé Térmico Regulação	Contactora Tripolar	P.U.€
QE-QA3BM01-0116	C/Relé Térmico 1-1,6A - 230Vac	0,50	0,37	1,1	1-1,6A	12A	330,00€
QE-QA3BM01-01625	C/Relé Térmico 1,6-2,5A - 230Vac	0,75	0,55	1,6	1,6-2,5A	12A	330,00€
QE-QA3BM01-0254	C/Relé Térmico 2,5-4A - 230Vac	1	0,75	2,1	2,5-4A	12A	330,00€
QE-QA3BM01-0406	C/Relé Térmico 4-6A - 230Vac	1,5-2	1,1-1,5	3-3,9	4-6A	12A	330,00€
QE-QA3BM01-0558	C/Relé Térmico 5,5-8A - 230Vac	3	2,20	5,8	5,5-8A	12A	330,00€
QE-QA3BM01-0710	C/Relé Térmico 7-10A - 230Vac	4-5	3-3,7	7,5-6	7-10A	12A	330,00€
QE-QA3BM01-0913	C/Relé Térmico 9,13A - 230Vac	5,5	4	9,8	9-13A	18A	330,00€
QE-QA3BM01-1218	C/Relé Térmico 12-18A - 230Vac	7,5	5,6	13,5	12-18A	18A	330,00€

Quadro Alternância Monofásico para 3 Bombas, para sondas Nível

Com Proteção Através de Relé Térmico sem Disjuntor

Contactora e Relé Térmico 

Funcionamento Automático/Desligado comandado por um comutador 2 Posições

Proteção contra Sobrecargas através de Relé Térmico

Indicação Motor Ligado (Sinalizador Verde)

Indicação Disparo Térmico (Sinalizador Vermelho)



Código	Monofásico	HP	Potência KW	Intensidade Amperes	Relé Térmico Regulação	Contactora Tripolar	P.U.€
QE-QA3BM02-0116	C/Relé Térmico 1-1,6A - 230Vac	0,50	0,37	1,1	1-1,6A	12A	360,00€
QE-QA3BM02-01625	C/Relé Térmico 1,6-2,5A - 230Vac	0,75	0,55	1,6	1,6-2,5A	12A	360,00€
QE-QA3BM02-0254	C/Relé Térmico 2,5-4A - 230Vac	1	0,75	2,1	2,5-4A	12A	360,00€
QE-QA3BM02-0406	C/Relé Térmico 4-6A - 230Vac	1,5-2	1,1-1,5	3-3,9	4-6A	12A	360,00€
QE-QA3BM02-0558	C/Relé Térmico 5,5-8A - 230Vac	3	2,20	5,8	5,5-8A	12A	360,00€
QE-QA3BM02-0710	C/Relé Térmico 7-10A - 230Vac	4-5	3-3,7	7,5-6	7-10A	12A	360,00€
QE-QA3BM02-0913	C/Relé Térmico 9,13A - 230Vac	5,5	4	9,8	9-13A	18A	360,00€
QE-QA3BM02-1218	C/Relé Térmico 12-18A - 230Vac	7,5	5,6	13,5	12-18A	18A	360,00€

Quadros Alternância p/3 Bombas

Quadro Alternância Trifásico para 3 Bombas

Com Proteção Através de Relé Térmico sem Disjuntor
Contactor e Relé Térmico **soflight**[®]
Funcionamento Automático/Desligado comandado por um comutador 2 Posições
Proteção contra Sobrecargas através de Relé Térmico
Indicação Motor Ligado (Sinalizador Verde)
Indicação Disparo Térmico (Sinalizador Vermelho)



Código	Trifásico	HP	Potência KW	Intensidade Amperes	Relé Térmico Regulação	Contactor Tripolar	P.U.€
QE-QA3BT01-0116	C/Relé Térmico 1-1,6A - 400Vac	0,50	0,37	1,1	1-1,6A	12A	390,00€
QE-QA3BT01-01625	C/Relé Térmico 1,6-2,5A - 400Vac	0,75	0,55	1,6	1,6-2,5A	12A	390,00€
QE-QA3BT01-0254	C/Relé Térmico 2,5-4A - 400Vac	1	0,75	2,1	2,5-4A	12A	390,00€
QE-QA3BT01-0406	C/Relé Térmico 4-6A - 400Vac	1,5-2	1,1-1,5	3-3,9	4-6A	12A	390,00€
QE-QA3BT01-0558	C/Relé Térmico 5,5-8A - 400Vac	3	2,20	5,8	5,5-8A	12A	390,00€
QE-QA3BT01-0710	C/Relé Térmico 7-10A - 400Vac	4-5	3-3,7	7,5-6	7-10A	12A	390,00€
QE-QA3BT01-0913	C/Relé Térmico 9,13A - 400Vac	5,5	4	9,8	9-13A	18A	390,00€
QE-QA3BT01-1218	C/Relé Térmico 12-18A - 400Vac	7,5	5,6	13,5	12-18A	18A	390,00€

Quadro Alternância Trifásico para 3 Bombas, para sondas Nível

Com Proteção Através de Relé Térmico sem Disjuntor
Contactor e Relé Térmico **soflight**[®]
Funcionamento Automático/Desligado comandado por um comutador 2 Posições
Proteção contra Sobrecargas através de Relé Térmico
Indicação Motor Ligado (Sinalizador Verde)
Indicação Disparo Térmico (Sinalizador Vermelho)



Código	Trifásico	HP	Potência KW	Intensidade Amperes	Relé Térmico Regulação	Contactor Tripolar	P.U.€
QE-QA3BT02-0116	C/Relé Térmico 1-1,6A - 400Vac	0,50	0,37	1,1	1-1,6A	12A	399,90€
QE-QA3BT02-01625	C/Relé Térmico 1,6-2,5A - 400Vac	0,75	0,55	1,6	1,6-2,5A	12A	399,90€
QE-QA3BT02-0254	C/Relé Térmico 2,5-4A - 400Vac	1	0,75	2,1	2,5-4A	12A	399,90€
QE-QA3BT02-0406	C/Relé Térmico 4-6A - 400Vac	1,5-2	1,1-1,5	3-3,9	4-6A	12A	399,90€
QE-QA3BT02-0558	C/Relé Térmico 5,5-8A - 400Vac	3	2,20	5,8	5,5-8A	12A	399,90€
QE-QA3BT02-0710	C/Relé Térmico 7-10A - 400Vac	4-5	3-3,7	7,5-6	7-10A	12A	399,90€
QE-QA3BT02-0913	C/Relé Térmico 9,13A - 400Vac	5,5	4	9,8	9-13A	18A	399,90€
QE-QA3BT02-1218	C/Relé Térmico 12-18A - 400Vac	7,5	5,6	13,5	12-18A	18A	399,90€

Quadro de Piscina para 1 Bomba

- * Quadro Eléctrico protege a Electrobomba termicamente através de 1 Interruptor Horário electromecânico
- * Possibilita a programação do tempo de funcionamento da electrobomba
- * Dispõe de 1 Disjuntor para ligar a eletrobomba manualmente
- * Montagem em Quadro IP 65 para 12 Módulos com Tampa Transparente homologado segundo a norma IEC60439
- * Inclui: Disjuntor Motor, Contactador Modular, Interruptor Diferencial Tipo AC 30mA Interruptor Horário, 1 a 2 Disjuntores unipolares para comando dos projectores



Código	Monofásico	Potência		Intensidade Amperes	Relé Térmico Regulação	Contactor Tripolar	Disjuntor 4,5kA		P.U.€
		HP	KW				Nº Polos	Amp.	
QE-QPM01-0254	C/Disjuntor Motor 2,5-4A - 230Vac	0,33-0,50	0,25-0,37	2,8-3,5	2,5-4A	12A	2	6-10	170,00€
QE-QPM01-0406	C/Disjuntor Motor 4-6A - 230Vac	0,75-1	0,55-0,74	4,5-5,7	4-6,3A	12A	2	10-16	170,00€
QE-QPM01-0610	C/Disjuntor Motor 6-10A - 230Vac	1,5	1,10	8,7	6-10A	12A	2	10-16	170,00€
QE-QPM01-0813	C/Disjuntor Motor 8-13A - 230Vac	2	1,50	10,7	9-14A	18A	2	25	170,00€
QE-QPM01-1318	C/Disjuntor Motor 13-18A - 230Vac	3	2,20	14,7	13-18A	18A	2	32	170,00€

Código	Trifásico	Potência		Intensidade Amperes	Relé Térmico Regulação	Contactor Tripolar	Disjuntor 4,5kA		P.U.€
		HP	KW				Nº Polos	Amp.	
QE-QPT01-0116	C/Disjuntor Motor 1-1,6A - 400Vac	0,50	0,37	1,1	1-1,6A	12A	3	6	200,00€
QE-QPT01-01625	C/Disjuntor Motor 1,6-2,5A - 400Vac	0,75	0,55	1,6	1,6-2,5A	12A	3	6	200,00€
QE-QPT01-0254	C/Disjuntor Motor 2,5-4A - 400Vac	1	0,75	2,1	2,5-4A	12A	3	6	200,00€
QE-QPT01-0406	C/Disjuntor Motor 4-6A - 400Vac	1,5-2	1,1-1,5	3-3,9	4-6,3A	12A	3	6-10	200,00€
QE-QPT01-0610	C/Disjuntor Motor 6-10A - 400Vac	4-5	3-3,7	7,5-9	6-10A	12A	3	20	200,00€
QE-QPT01-0813	C/Disjuntor Motor 8-13A - 400Vac	5,5	4	9,8	9-14A	18A	3	20	200,00€
QE-QPT01-13-18	C/Disjuntor Motor 13-18A - 400Vac	7,5	5,6	13,5	13-18A	18A	3	32	200,00€

Quadro de Piscina para 1 Bomba (ECO)

- * Quadro Eléctrico protege a Electrobomba termicamente através de 1 Interruptor Horário electromecânico
- * Possibilita a programação do tempo de funcionamento da electrobomba
- * Selector 3 Posições (Manual / Desligado / Automático)
- * Montagem em Caixa Estanque IP 65 com Tampa Transparente
- * Inclui Contactor, Relé Térmico, Interruptor Horário, Disjuntor 4,5kA (FN/Monofásico - 3P Trifásico)



Código	Monofásico	Potência		Intensidade Amperes	Relé Térmico Regulação	Contactor Tripolar	Disjuntor 4,5kA		P.U.€
		HP	KW				Nº Polos	Amp.	
QE-QPM02-0254	C/Relé Térmico 2,5-4A - 230Vac	0,33-0,50	0,25-0,37	2,8-3,5	2,5-4A	12A	2	6-10	96,00€
QE-QPM02-0406	C/Relé Térmico 4-6A - 230Vac	0,75-1	0,55-0,74	4,5-5,7	4-6A	12A	2	10-16	96,00€
QE-QPM02-0558	C/Relé Térmico 5,5-8A - 230Vac	0,75-1	0,55-0,74	4,5-5,7	5,5-8A	12A	2	10-16	96,00€
QE-QPM02-0710	C/Relé Térmico 7-10A - 230Vac	1,5	1-1,0	8,7	7-10A	12A	2	20	96,00€
QE-QPM02-0913	C/Relé Térmico 9-13A - 230Vac	2	1,50	10,7	9-13A	18A	2	25	96,00€
QE-QPM02-1218	C/Relé Térmico 12-18A - 230Vac	3	2,20	14,7	12-18A	18A	2	32	96,00€

Código	Trifásico	Potência		Intensidade Amperes	Relé Térmico Regulação	Contactor Tripolar	Disjuntor 4,5kA		P.U.€
		HP	KW				Nº Polos	Amp.	
QE-QPT02-0116	C/Relé Térmico 1-1,6A - 400Vac	0,50	0,37	1,1	1-1,6A	12A	3	6	99,50€
QE-QPT02-01625	C/Relé Térmico 1,6-2,5A - 400Vac	0,75	0,55	1,6	1,6-2,5A	12A	3	6	99,50€
QE-QPT02-0254	C/Relé Térmico 2,5-4A - 400Vac	1	0,75	2,1	2,5-4A	12A	3	6	99,50€
QE-QPT02-0406	C/Relé Térmico 4-6A - 400Vac	1,5-2	1,1-1,5	3-3,9	4-6A	12A	3	6-10	99,50€
QE-QPT02-0558	C/Relé Térmico 5,5-8A - 400Vac	3	2,20	5,8	5,5-8A	12A	3	16	99,50€
QE-QPT02-0710	C/Relé Térmico 7-10A - 400Vac	4-5	3-3,7	7,5-6	7-10A	12A	3	16-20	99,50€
QE-QPT02-0913	C/Relé Térmico 9,13A - 400Vac	5,5	4	9,8	9-13A	18A	3	20	99,50€
QE-QPT02-1218	C/Relé Térmico 12-18A - 400Vac	7,5	5,6	13,5	12-18A	18A	3	32	99,50€



Quadro de Piscina para 1 Bomba com Programação

* Montagem em Quadro IP 65 para 12 Módulos com Tampa Transparente

* Inclui:

- Disjuntor Motor Ajustado à Amperagem da Bomba
- Interruptor Diferencial Tipo AC 30mA
- Disjuntor Unipolar 16A
- Contactor Modular 25A
- 2 Botões Pressão (Ligar e desligar Manualmente a Bomba e Iluminação)
- Relé **Toscano** TPM Poll-B que possibilita:

- * Programação 1 ou 2 Vezes por dia funcionamento da electrobomba
- * Programação 1 Vez por dia funcionamento Iluminação
- * Programação 1 Vez por dia funcionamento Iluminação RGB
- * Programação do Relé TPM Poll-B por Bluetooth

-Homologado segundo a norma IEC60439



Código	Monofásico	HP	Potência KW	Intensidade Amperes	Relé Térmico Regulação	Contactora Tripolar	Disjuntor 4,5kA Nº Polos Amp.	P.U.€
QE-QPM03-0254	C/Disjuntor Motor 2,5-4A - 230Vac	0,33-0,50	0,25-0,37	2,8-3,5	2,5-4A	12A	2 6-10	448.00€
QE-QPM03-0406	C/Disjuntor Motor 4-6A - 230Vac	0,75-1	0,55-0,74	4,5-5,7	4-6,3A	12A	2 10-16	448.00€
QE-QPM03-0610	C/Disjuntor Motor 6-10A - 230Vac	1,5	1,10	8,7	6-10A	12A	2 10-16	448.00€
QE-QPM03-0914	C/Disjuntor Motor 9-14A - 230Vac	2	1,50	10,7	9-14A	18A	2 25	448.00€
QE-QPM03-1318	C/Disjuntor Motor 13-18A - 230Vac	3	2,20	14,7	13-18A	18A	2 32	448.00€

Código	Trifásico	HP	Potência KW	Intensidade Amperes	Relé Térmico Regulação	Contactora Tripolar	Disjuntor 4,5kA Nº Polos Amp.	P.U.€
QE-QPT03-0116	C/Disjuntor Motor 1-1,6A - 400Vac	0,50	0,37	1,1	1-1,6A	12A	3 6	505.00€
QE-QPT03-01625	C/Disjuntor Motor 1,6-2,5A - 400Vac	0,75	0,55	1,6	1,6-2,5A	12A	3 6	505.00€
QE-QPT03-0254	C/Disjuntor Motor 2,5-4A - 400Vac	1	0,75	2,1	2,5-4A	12A	3 6	505.00€
QE-QPT03-0406	C/Disjuntor Motor 4-6A - 400Vac	1,5-2	1,1-1,5	3-3,9	4-6,3A	12A	3 6-10	505.00€
QE-QPT03-0610	C/Disjuntor Motor 6-10A - 400Vac	4-5	3-3,7	7,5-9	6-10A	12A	3 20	505.00€
QE-QPT03-0914	C/Disjuntor Motor 9-14A - 400Vac	5,5	4	9,8	9-14A	18A	3 20	505.00€
QE-QPT03-1318	C/Disjuntor Motor 13-18A - 400Vac	7,5	5,6	13,5	13-18A	18A	3 32	505.00€

Quadro de Piscina para 1 Bomba

* Montagem em Quadro IP 65 para 12 Módulos com Tampa Transparente

* Inclui:

- Disjuntor Motor Ajustado à Amperagem da Bomba
- Interruptor Diferencial Tipo AC 30mA
- Disjuntor Unipolar 16A
- Contactor Modular 25A
- 2 Botões Pressão (Ligar e desligar Manualmente a Bomba e Iluminação)
- Relé **Toscano** TPM Poll que possibilita:

- * Programação 1 ou 2 Vezes por dia funcionamento da electrobomba
- * Programação 1 Vez por dia funcionamento Iluminação
- * Programação 1 Vez por dia funcionamento Iluminação RGB

-Homologado segundo a norma IEC60439



Código	Monofásico	HP	Potência KW	Intensidade Amperes	Relé Térmico Regulação	Contactora Tripolar	Disjuntor 4,5kA Nº Polos Amp.	P.U.€
QE-QPM04-0254	C/Disjuntor Motor 2,5-4A - 230Vac	0,33-0,50	0,25-0,37	2,8-3,5	2,5-4A	12A	2 6-10	348.00€
QE-QPM04-0406	C/Disjuntor Motor 4-6A - 230Vac	0,75-1	0,55-0,74	4,5-5,7	4-6,3A	12A	2 10-16	348.00€
QE-QPM04-0610	C/Disjuntor Motor 6-10A - 230Vac	1,5	1,10	8,7	6-10A	12A	2 10-16	348.00€
QE-QPM04-0914	C/Disjuntor Motor 9-14A - 230Vac	2	1,50	10,7	9-14A	18A	2 25	348.00€
QE-QPM04-1318	C/Disjuntor Motor 13-18A - 230Vac	3	2,20	14,7	13-18A	18A	2 32	348.00€

Código	Trifásico	HP	Potência KW	Intensidade Amperes	Relé Térmico Regulação	Contactora Tripolar	Disjuntor 4,5kA Nº Polos Amp.	P.U.€
QE-QPT04-0116	C/Disjuntor Motor 1-1,6A - 400Vac	0,50	0,37	1,1	1-1,6A	12A	3 6	400.00€
QE-QPT04-01625	C/Disjuntor Motor 1,6-2,5A - 400Vac	0,75	0,55	1,6	1,6-2,5A	12A	3 6	400.00€
QE-QPT04-0254	C/Disjuntor Motor 2,5-4A - 400Vac	1	0,75	2,1	2,5-4A	12A	3 6	400.00€
QE-QPT04-0406	C/Disjuntor Motor 4-6A - 400Vac	1,5-2	1,1-1,5	3-3,9	4-6,3A	12A	3 6-10	400.00€
QE-QPT04-0610	C/Disjuntor Motor 6-10A - 400Vac	4-5	3-3,7	7,5-9	6-10A	12A	3 20	400.00€
QE-QPT04-0914	C/Disjuntor Motor 9-14A - 400Vac	5,5	4	9,8	9-14A	18A	3 20	400.00€
QE-QPT04-1318	C/Disjuntor Motor 13-18A - 400Vac	7,5	5,6	13,5	13-18A	18A	3 32	400.00€

HF

ABS

IP65



CE

Quadros ABS c/Platine Metálica

Temperatura de trabalho: -40° C / + 80° C

RAL : 7035

650° C Glow Wire (Stand)

960° C Glow Wire (HF tipo)

Parafusos em Inox

Resistência Impacto

Platine Metálica Incluída



Código	Altura	Largura	Profund.	Platina	P.U.€
SL-08-200300130	300mm	200mm	130mm	1,5mm	44,20€
SL-08-300400170	400mm	300mm	170mm	1,5mm	60,50€
SL-08-300400220	400mm	300mm	220mm	1,5mm	75,60€
SL-08-400500180	500mm	400mm	180mm	1,5mm	78,30€
SL-08-400500240	500mm	400mm	240mm	1,5mm	105,50€
SL-08-400600200	600mm	400mm	200mm	1,5mm	115,00€
SL-08-500700250	700mm	500mm	250mm	1,5mm	185,00€
SL-08-600800260	800mm	600mm	260mm	1,5mm	275,00€

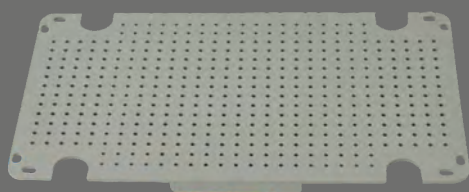

Platine Pástico p/Quadros ABS

Código	Altura	Largura	Espes.	Q/P	P.U.€
SL-08-PLA400300	400mm	300mm	2,5mm	ABS	3,10€
SL-08-PLA500400	500mm	400mm	2,5mm	ABS	4,00€
SL-08-PLA600400	600mm	400mm	2,5mm	ABS	8,25€



Grelha com Filtro para Quadros

Código	Altura	Largura	Q/P	P.U.€
SL-08-GRE105	105mm	105mm	ABS	5,60€
SL-08-GRE150	150mm	150mm	ABS	7,90€
SL-08-GRE250	250mm	250mm	ABS	15,50€



Chassi para Quadros em ABS

Código	Altura	Largura	Profund.	Q/P	NºMod.	P.U.€
SL-08-CH300X400	300mm	200mm	130mm	ABS	2x12	22,50€
SL-08-CH400X500	400mm	500mm	190mm	ABS	3x15	27,50€
SL-08-CH400X600	400mm	600mm	200mm	ABS	4x15	31,80€



Porta Documentos

Código	Altura	Largura	Q/P	P.U.€
SL-08-PDA4	230mm	218mm	A4	8,30€
SL-08-PDA5	175mm	206mm	A5	6,90€

Quadros Metálicos

Quadro Metálico com Porta 1,2mm
Platina Metálica Incluída 2mm
RAL 7035, IP 66
Alta Resistência a Impactos, IK 10
Resistência em Ambientes Corrosivos
IEC60529, EN61000-6-1, EN61000-6-3

Chassi Metálico para Quadros Metálicos
200mm profundidade RAL 7035

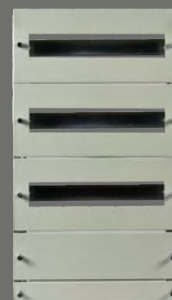

Código	Altura	Largura	Profund.	Q/P	Platina	P.U.€	Código	Altura	Largura	Nº Módulos	P.U.€
SL-QMP25.20.15	250mm	200mm	150mm	1,2mm	1,5mm	50,20€	SL-CHM40.30	400mm	300mm	2 x 9=18	59,00€
SL-QMP30.25.15	300mm	250mm	150mm	1,2mm	1,5mm	60,40€	SL-CHM50.40	500mm	400mm	3 X 15=45	73,00€
SL-QMP40.30.15	400mm	300mm	150mm	1,2mm	1,5mm	82,25€	SL-CHM60.40	600mm	400mm	3 X 15=45	80,00€
SL-QMP40.30.20	400mm	300mm	200mm	1,2mm	1,5mm	86,10€	SL-CHM70.50/3	700mm	500mm	3 X 21=63	105,00€
SL-QMP50.40.15	500mm	400mm	150mm	1,2mm	1,5mm	114,80€	SL-CHM70.50/4	700mm	500mm	4 X 21=84	108,00€
SL-QMP50.40.20	500mm	400mm	200mm	1,2mm	1,5mm	126,80€	SL-CHM80.60/3	800mm	600mm	3 X 26=78	125,00€
SL-QMP60.40.15	600mm	400mm	150mm	1,2mm	1,5mm	136,60€	SL-CHM80.60/4	800mm	600mm	4 X 26=104	135,00€
SL-QMP60.40.20	600mm	400mm	200mm	1,2mm	1,5mm	145,10€	SL-CHM100.60	1000mm	600mm	6 X 26=156	158,00€
SL-QMP60.40.30	600mm	400mm	300mm	1,2mm	1,5mm	145,10€					
SL-QMP70.50.20	700mm	500mm	200mm	1,2mm	1,5mm	205,60€					
SL-QMP70.50.25	700mm	500mm	250mm	1,2mm	1,5mm	218,80€					
SL-QMP80.60.25	800mm	600mm	250mm	1,5mm	2,0mm	308,50€					
SL-QMP80.60.30	800mm	600mm	300mm	1,5mm	2,0mm	321,60€					
SL-QMP100.60.30	1000mm	600mm	300mm	1,5mm	2,0mm	385,00€					
SL-QMP100.80.30	1000mm	800mm	300mm	1,5mm	2,0mm	435,00€					
SL-QMP120.100.30	1200mm	1000mm	300mm	1,5mm	2,0mm	606,00€					
SL-QMP120.100.40	1200mm	1000mm	400mm	1,5mm	2,0mm	656,00€					
SL-QMP140.120.40	1400mm	1200mm	400mm	1,5mm	2,0mm	866,00€					



Armários Metálicos Configuráveis RAL 7035, IP 65

Armários Configuráveis	Perfil	Topo + Base	Porta Frontal + Painel Traseiro	Painéis Laterais	Platina Metálica	Base / Rodapé
Altura:1600mm Largura:600mm Profundidade:400mm	SL-PER16 P.U.: 175,00€	SL-TB64 P.U.: 250,00€	SL-PFPT16 P.U.: 310,00€	SL-PL164 P.U.: 165,00€	SL-PM166 P.U.: 135,00€	SL-BA64.100 P.U.: 38,00€
Altura:2000mm Largura:600mm Profundidade:400mm	SL-PER20 P.U.: 210,00€	SL-TB64 P.U.: 250,00€	SL-PFPT206 P.U.: 365,00€	SL-PL204 P.U.: 185,00€	SL-PM206 P.U.: 168,00€	SL-BA64.100 P.U.: 38,00€

soflight®

Electric

Quadros Metálicos

**SL-MDP102**Placa Cega
600x198mm
RAL 7035

P.U. 43.00€

**SL-MDP104**Placa Cega
600x398mm
RAL 7035

P.U. 60.00€

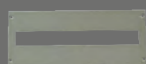
**SL-MDP125**Placa 1x25 Modulos
600x198mm
RAL 7035
Calha DIN Incluída
P.U. 53.00€**SL-MDP225**Placa 2x25 Modulos
600x398mm
RAL 7035
Calha DIN Incluída
P.U. 71.00€**SL-MDP602**Platina Metálica
508x200mm
RAL 7035

P.U. 39.00€

**SL-MDP603**Platina Metálica
508x300mm
RAL 7035

P.U. 47.00€

**SL-MDP604**Platina Metálica
508x400mm
RAL 7035

P.U. 56.00€

**SL-MDP606**Platina Metálica
508x600mm
RAL 7035

P.U. 73.00€

**SL-HW1600**Perfil Vertical
Kit 4 perfis
1600mm
Galvanizado

P.U. 230.00€

**SL-HW2000**Perfil Vertical
Kit 4 perfis
2000mm
Galvanizado

P.U. 262.00€

**SL-HU1600**Perfil Vertical
Kit 4 perfis
1600mm
RAL 7035

P.U. 225.00€

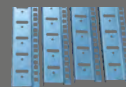
**SL-HU2000**Perfil Vertical
Kit 4 perfis
2000mm
RAL 7035

P.U. 268.00€

**SL-H1600**Perfil Vertical
Kit 2 perfis
1600mm
Galvanizado

P.U. 86.00€

**SL-H2000**Perfil Vertical
Kit 2 perfis
2000mm
Galvanizado

P.U. 107.00€

**SL-WD400**Perfil Horizontal
(Kit 4 Peças)Galvanizado
P.U. 70.00€**SL-WD470**Perfil para
Porta 600mmRAL 7035
P.U. 20.00€**SL-LP208.90**Placa Ventilação
208x90mm

P.U. 13.00€

**SL-LP244.90**Placa Ventilação
244x90mm

P.U. 14.00€

**SL-LP358-128**Placa Ventilação
358x128mm

P.U. 18.00€

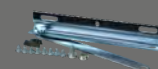
**SL-PP100**Suporte Plástico
Para Folhas A4
600x398mm
Cor: Laranja
P.U. 9.50**SL-PP600**Suporte Metálico
P/ Projectos
455x260x90mm
Cor: Laranja
P.U. 56.00€**SL-WA010**Parafuso
Prolongador
Kit 6 pcs
Galvanizado
P.U. 20.00€**SL-WA020**Kit Acessórios
4 Peças para
União Quadros
Galvanizado
P.U. 28.00€**SL-WA030**Kit Acessórios
Para União de
Dois Quadros
Galvanizado
P.U. 7.20€**SL-SN-M6**Inserção
Para perfil
Galvanizado
P.U. 1.5€**SL-MP64**Platina Metálica
492x333mm
Galvanizado
P.U. 123.00€**SL-DS100**Travamento
Porta
Galvanizado
P.U. 12.00€**SL-TSN-M6**Inserção
Para Perfil

P.U. 2.50€

**SL-WA6**Inserção
Para Perfil

P.U. 2.50€

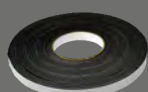
**SL-RUB10**Rolo com 10 mts
Junta para
Armários Metálicos

P.U. 15.00€

**SL-SUP.02**Suporte para
Calha DIN

P.U. 2.50€

**SL-SUP.02.45**Suporte para
Calha DIN 45°

P.U. 2.50€

Sinalizador em Led



Código	Cor	Fio	Tensão	P.U.€
SL-SI-S010VM-024	Vermelho	200mm	24Vdc	1,40€
SL-SI-S010VD-024	Verde	200mm	24Vdc	1,40€
SL-SI-S010AM-024	Amarelo	200mm	24Vdc	1,40€
SL-SI-S010VM-230	Vermelho	200mm	230Vac	1,40€
SL-SI-S010VD-230	Verde	200mm	230Vac	1,40€
SL-SI-S010AM-230	Amarelo	200mm	230VC	1,40€
SL-SI-S010VM-400	Vermelho	200mm	400Vac	1,40€
SL-SI-S010VD-400	Verde	200mm	400Vac	1,40€
SL-SI-S010AM-400	Amarelo	200mm	400Vac	1,40€

Sinalizador em Led



Código	Cor	Fio	Tensão	P.U.€
SL-SI-S020VM-024	Vermelho	300mm	24Vdc	1,40€
SL-SI-S020VD-024	Verde	300mm	24Vdc	1,40€
SL-SI-S020AM-024	Amarelo	300mm	24Vdc	1,40€
SL-SI-S020VM-230	Vermelho	300mm	230Vac	1,40€
SL-SI-S020VD-230	Verde	300mm	230Vac	1,40€
SL-SI-S020AM-230	Amarelo	300mm	230VC	1,40€
SL-SI-S020VM-400	Vermelho	300mm	400Vac	1,40€
SL-SI-S020VD-400	Verde	300mm	400Vac	1,40€
SL-SI-S020AM-400	Amarelo	300mm	400Vac	1,40€

Interruptores Painel 230Vac



Código	Cor	Tensão	P.U.€
SL-SI-I010VM-230	Vermelho	230Vac	3,00€
SL-SI-I010VD-230	Verde	230Vac	3,00€
SL-SI-I010-2X3PT	Preto	230Vac	3,30€
SL-SI-I010SILPRO	Silicone Proteção		1,00€

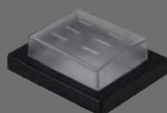

Código	Cor	P.U.€
SL-SI-I010SILPRO	Silicone Proteção	1,00€



Código	Cor	Botões	Tensão	P.U.€
SL-SI-I020VM-230	Vermelho	1 Botão	230Vac	2,80€

Código	Cor	Botões	Tensão	P.U.€
SL-SI-I020DVM-230	Vermelho	2 Botões	230Vac	4,40€

Interruptores Alavanca 230Vac

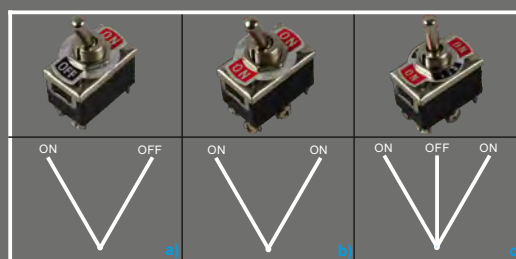

Código	Função	Dimensões	Furo	P.U.€
SL-SI-I1010-1P-10A	ON-OFF	19x29mm	12mm	2,40€
SL-SI-I1015-1P-10A	ON-ON	19x29mm	12mm	2,70€
SL-SI-I1020-1P-10A	ON-OFF-ON	19x29mm	12mm	2,70€
SL-SI-I1010-2P-10A	ON-OFF	20x32mm	12mm	3,30€
SL-SI-I1015-2P-10A	ON-ON	20x32mm	12mm	3,30€
SL-SI-I1020-2P-10A	ON-OFF-ON	20x32mm	12mm	3,30€



Código	Cor	Tensão	P.U.€
SL-SI-I030VM-230	Ver.Lum.0-1	230Vac	2,80€
SL-SI-I030PT-230	Preto 0-1	230Vac	1,80€
SL-SI-I032PT-230	Preto 1-0-2	230Vac	3,00€



Código	Cor	Tensão	P.U.€
SL-SI-I030SILPRO	Silicone Proteção	230Vac	0,60€

**SL-BD1025G**

Borne Calha DIN
 0,2-2,5mm²
 Cor: Cinza
 Qt/Emb. 50 Unidades
P.U. 0,52€

**SL-BD1004G**

Borne Calha DIN
 0,2-4mm²
 Cor: Cinza
 Qt/Emb. 50 Unidades
P.U. 0,58€

**SL-BD1006G**

Borne Calha DIN
 0,2-6mm²
 Cor: Cinza
 Qt/Emb. 50 Unidades
P.U. 1,00€

**SL-BD1010G**

Borne Calha DIN
 0,5-10mm²
 Cor: Cinza
 Qt/Emb. 40 Unidades
P.U. 1,45€

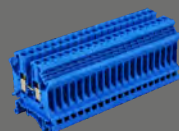
**SL-BD1025B**

Borne Calha DIN
 0,2-2,5mm²
 Cor: Azul
 Qt/Emb. 50 Unidades
P.U. 0,52€

**SL-BD1004B**

Borne Calha DIN
 0,2-4mm²
 Cor: Azul
 Qt/Emb. 50 Unidades
P.U. 0,58€

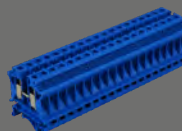
**SL-BD1006B**

Borne Calha DIN
 0,2-6mm²
 Cor: Azul
 Qt/Emb. 40 Unidades
P.U. 1,00€

**SL-BD1010B**

Borne Calha DIN
 0,5-10mm²
 Cor: Azul
 Qt/Emb. 40 Unidades
P.U. 1,45€

**SL-BD1025Y**

Borne Calha DIN
 0,2-2,5mm²
 Cor: Verde/Amarelo
 Qt/Emb. 100 Unidades
P.U. 1,85€

**SL-BD1004Y**

Borne Calha DIN
 0,2-4mm²
 Cor: Verde/Amarelo
 Qt/Emb. 100 Unidades
P.U. 1,90€

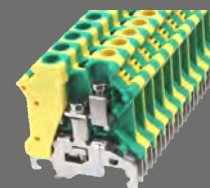
**SL-BD1006Y**

Borne Calha DIN
 0,2-6mm²
 Cor: Verde/Amarelo
 Qt/Emb. 50 Unidades
P.U. 2,45€

**SL-BD1010Y**

Borne Calha DIN
 0,5-10mm²
 Cor: Verde/Amarelo
 Qt/Emb. 50 Unidades
P.U. 2,65€

**SL-BD2025G**

Borne Calha DIN
 0,2-2,5mm²
 Cor: Cinza
 Qt/Emb. 50 Unidades
P.U. 1,16€

**SL-BD2040G**

Borne Calha DIN
 0,2-4mm²
 Cor: Cinza
 Qt/Emb. 50 Unidades
P.U. 1,35€

**SL-BD-END**

Borne Fixação
 Cor: Cinza
 Qt/Emb. 100 Unidades
P.U. 0,30€

**SL-BD1025-M**

Marcações para
 Borne 2,5mm
 Numéricas 1 a 10
 Qt/Emb. 100 Unidades
P.U. 0,22€

**SL-BD1004-M**

Marcações para
 Borne 4mm
 Numéricas 1 a 10
 Qt/Emb. 100 Unidades
P.U. 0,22€

**SL-BD1006-M**

Marcações para
 Borne 6mm
 Numéricas 1 a 10
 Qt/Emb. 100 Unidades
P.U. 0,30€

**SL-BD1010-M**

Marcações para
 Borne 6mm
 Numéricas 1 a 10
 Qt/Emb. 100 Unidades
P.U. 0,30€

Bucins Nylon

Bucins para Cabo

Material: PA6.6 Classe UL94-V-2

Grau de Proteção IP 68

Temperatura trabalho: -30°C / 80°C

Tipo Rosca: Métrica ou PG



Quantidade mínima venda, Saco completo.

Código	Rosca	Qt./Emb.	P.U.€
SL-B1007-CZ	PG 7 Cinza	100	0,20€
SL-B1007-PT	PG 7 Preto	100	0,20€
SL-B1009-CZ	PG 9 Cinza	100	0,23€
SL-B1009-PT	PG 9 Preto	100	0,23€
SL-B1011-CZ	PG 11 Cinza	100	0,25€
SL-B1011-PT	PG 11 Preto	100	0,25€
SL-B1013-CZ	PG 13,5 Cinza	100	0,33€
SL-B1013-PT	PG 13,5 Preto	100	0,33€
SL-B1016-CZ	PG 16 Cinza	100	0,36€
SL-B1016-PT	PG 16 Preto	100	0,36€
SL-B1021-CZ	PG 21 Cinza	100	0,58€
SL-B1021-PT	PG 21 Preto	100	0,58€
SL-B1029-CZ	PG 29 Cinza	50	0,97€
SL-B1029-PT	PG 29 Preto	50	0,97€
SL-B1036-CZ	PG 36 Cinza	50	1,70€
SL-B1036-PT	PG 36 Preto	50	1,70€
SL-B1042-CZ	PG 42 Cinza	20	2,20€
SL-B1042-PT	PG 42 Preto	20	2,20€
SL-B1048-CZ	PG 48 Cinza	20	2,80€
SL-B1048-PT	PG 48 Preto	20	2,80€
SL-B1063-CZ	PG 63 Cinza	20	5,40€
SL-B1063-PT	PG 63 Preto	20	5,40€

Livre de Halogênios



Quantidade mínima venda, Saco completo.

Código	Rosca	Qt./Emb.	P.U.€
SL-M1012-CZ	M 12 Cinza	100	0,27€
SL-M1012-PT	M12 Preto	100	0,27€
SL-M1016-CZ	M 16 Cinza	100	0,32€
SL-M 1016-PT	M 16 Preto	100	0,32€
SL-M1020-CZ	M 20 Cinza	100	0,39€
SL-M1020-PT	M 20 Preto	100	0,39€
SL-M1025-CZ	M 25 Cinza	100	0,60€
SL-M1025-PT	M 25 Preto	100	0,60€
SL-M1032-CZ	M 32 Cinza	100	0,97€
SL-M1032-PT	M 32 Preto	100	0,97€
SL-M1040-CZ	M 40 Cinza	20	1,93€
SL-M1040-PT	M 40 Preto	20	1,93€
SL-M1050-CZ	M 50 Cinza	20	2,75€
SL-M1050-PT	M 50 Preto	20	2,75€
SL-M1063-CZ	M 63 Cinza	20	3,20€
SL-M1063-PT	M 63 Preto	20	3,20€



Quantidade mínima venda, Saco completo.

Código	Descrição	Qt./Emb.	P.U.€
SL-PF-20	Passa Fios, Furo 20mm	100	0,15€
SL-PF-32	Passa Fios, Furo 32mm	100	0,25€



Quantidade mínima venda, Saco completo.

Código	Descrição	Qt./Emb.	P.U.€
SL-PF	Passa Fios, Furo 20mm	100	0,15€

Bucins para Cabo

Material: Latão Niquelado

Grau de Proteção IP 68

Temperatura trabalho: -30°C / 80°C

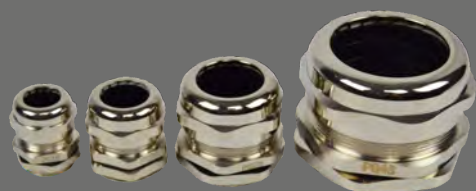
Bucins Latão / Inox
Bucins para Cabo

Material: Inox 316

Grau de Proteção IP 68

Temperatura trabalho: -30°C / 80°C

Bucim Metálico, PG

Quantidade mínima venda Saco completo.

Código	Rosca	Qt./Emb.	P.U.€
SL-B2007-MT	PG 7 Metálico	200	1,42€
SL-B2009-MT	PG 9 Metálico	100	1,58€
SL-B2011-MT	PG 11 Metálico	100	1,90€
SL-B2013-MT	PG 13,5 Metálico	100	2,10€
SL-B2016-MT	PG 16 Metálico	50	2,50€
SL-B2021-MT	PG 21 Metálico	50	3,75€
SL-B2029-MT	PG 29 Metálico	20	7,75€
SL-B2036-MT	PG 36 Metálico	12	15,30€
SL-B2042-MT	PG 42 Metálico	6	16,80€
SL-B2048-MT	PG 48 Metálico	6	24,75€

Bucim Inox 316, PG

Quantidade mínima venda Saco c/10 Unid.

Código	Rosca	Ø Cabos	Emb. (saco)	P.U.€
SL-BI31607	PG 7	3-6,5mm	10unid.	16,00€
SL-BI31609	PG 9	4-8mm	10unid.	21,00€
SL-BI31611	PG 11	5-10mm	10unid.	22,50€
SL-BI31613	PG 13,5	6-12mm	10unid.	23,20€
SL-BI31616	PG 16	10-14mm	10unid.	25,50€
SL-BI31621	PG 21	13-18mm	10unid.	27,00€
SL-BI31629	PG 29	18-25mm	10unid.	30,30€
SL-BI31636	PG 36	25-33mm	10unid.	61,00€
SL-BI31642	PG 42	32-38mm	10unid.	147,50€
SL-BI31648	PG 48	37-44mm	10unid.	190,00€

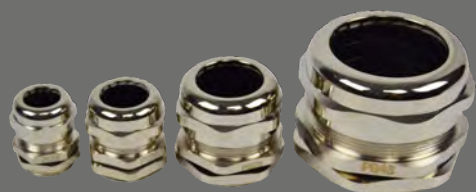
Bucim Metálico, Métrico

Quantidade mínima venda Saco completo.

Código	Rosca	Qt./Emb.	P.U.€
SL-M2012-MT	M 12 Metálico(3-6,5mm)	100	1,58€
SL-M2016-MT	M 16 Metálico(4-8mm)	50	1,80€
SL-M2016-S-MT	M 16 Metálico (6-12mm)	10	1,80€
SL-M2018-MT	M 18 Metálico(5-10mm)	50	1,80€
SL-M2020-MT	M 20 Metálico(6-12mm)	20	2,65€
SL-M2022-MT	M 22 Metálico(10-14mm)	20	2,65€
SL-M2025-MT	M 25 Metálico(13-18mm)	20	3,15€
SL-M2028-MT	M 28 Metálico(13-18mm)	20	3,80€
SL-M2032-MT	M 32 Metálico(15-22mm)	12	5,80€
SL-M2037-MT	M 37 Metálico(18-25mm)	12	5,80€
SL-M2040-MT	M 40 Metálico(22-30mm)	12	9,00€
SL-M2050-MT	M 50 Metálico(32-38mm)	9	15,30€
SL-M2063-MT	M 63 Metálico(37-44mm)	6	26,90€
SL-M2075-MT	M 75 Metálico(42-52mm)	4	100,00€
SL-M2080-MT	M 80 Metálico(55-62mm)	4	175,00€
SL-M20100-MT	M 100 Metálico(78-84mm)	2	340,00€

Bucim Inox 316, Métrico

Quantidade mínima venda Saco c/10 Unid.

Código	Rosca	Ø Cabos	Emb. (saco)	P.U.€
SL-MI31612	M12	3-6,5mm	10unid.	16,00€
SL-MI31616	M16	4-8mm	10unid.	21,00€
SL-MI31620	M20	6-12mm	10unid.	24,50€
SL-MI31625	M25	10-14mm	10unid.	23,30€
SL-MI31632	M32	15-22mm	10unid.	34,70€
SL-MI31640	M40	18-25mm	10unid.	50,00€
SL-MI31650	M50	32-38mm	10unid.	69,70€
SL-MI31663	M63	37-44mm	10unid.	158,00€
SL-MI31675	M75	42-52mm	10unid.	280,00€
SL-MI31680	M80	37-44mm	10unid.	342,00€
SL-MI316100	M100	78-84mm	10unid.	495,00€



Tampões Nylon / Metálicos

Tampões Roscados em Nylon

Material: Nylon
Material: IP 65 / 68
Temperatura trabalho: -30°C / 80°C



Tampões Roscados em Nylon

Material: Nylon
Material: IP 65 / 68
Temperatura trabalho: -30°C / 80°C



Tampões em Nylon PG

Quantidade mínima venda Saco c/10 Unid.

Código	Rosca	Cor	Acab.	Emb. (saco)	P.U.€
SL-TPP07CZ	PG 7	Cinza	Nylon	10unid.	0,19€
SL-TPP07PT	PG 7	Preto	Nylon	10unid.	0,19€
SL-TPP09CZ	PG 9	Cinza	Nylon	10unid.	0,22€
SL-TPP09PT	PG 9	Preto	Nylon	10unid.	0,22€
SL-TPP11CZ	PG 11	Cinza	Nylon	10unid.	0,25€
SL-TPP11PT	PG 11	Preto	Nylon	10unid.	0,25€
SL-TPP13CZ	PG 13,5	Cinza	Nylon	10unid.	0,30€
SL-TPP13PT	PG 13,5	Preto	Nylon	10unid.	0,30€
SL-TPP16CZ	PG 16	Cinza	Nylon	10unid.	0,38€
SL-TPP16PT	PG 16	Preto	Nylon	10unid.	0,38€
SL-TPP21CZ	PG 21	Cinza	Nylon	10unid.	0,50€
SL-TPP21PT	PG 21	Preto	Nylon	10unid.	0,50€
SL-TPP29CZ	PG 29	Cinza	Nylon	10unid.	0,70€
SL-TPP29PT	PG 29	Preto	Nylon	10unid.	0,70€
SL-TPP36CZ	PG 36	Cinza	Nylon	10unid.	1,40€
SL-TPP36PT	PG 36	Preto	Nylon	10unid.	1,40€
SL-TPP42CZ	PG 42	Cinza	Nylon	10unid.	1,80€
SL-TPP42PT	PG 42	Preto	Nylon	10unid.	1,80€
SL-TPP48CZ	PG 48	Cinza	Nylon	10unid.	2,30€
SL-TPP48PT	PG 48	Preto	Nylon	10unid.	2,30€

Tampões em Nylon Métricos

Quantidade mínima venda Saco c/10 Unid.

Código	Rosca	Cor	Acab.	Emb. (saco)	P.U.€
SL-TPM12CZ	M12	Cinza	Nylon	10unid.	0,19€
SL-TPM12PT	M12	Preto	Nylon	10unid.	0,19€
SL-TPM16CZ	M16	Cinza	Nylon	10unid.	0,22€
SL-TPM16PT	M16	Preto	Nylon	10unid.	0,22€
SL-TPM20CZ	M20	Cinza	Nylon	10unid.	0,25€
SL-TPM20PT	M20	Preto	Nylon	10unid.	0,25€
SL-TPM25CZ	M25	Cinza	Nylon	10unid.	0,40€
SL-TPM25PT	M25	Preto	Nylon	10unid.	0,40€
SL-TPM32CZ	M32	Cinza	Nylon	10unid.	0,50€
SL-TPM32PT	M32	Preto	Nylon	10unid.	0,50€
SL-TPM40CZ	M40	Cinza	Nylon	10unid.	0,90€
SL-TPM40PT	M40	Preto	Nylon	10unid.	0,90€
SL-TPM50CZ	M50	Cinza	Nylon	10unid.	1,80€
SL-TPM50PT	M50	Preto	Nylon	10unid.	1,80€
SL-TPM63CZ	M63	Cinza	Nylon	10unid.	2,30€
SL-TPM63PT	M63	Preto	Nylon	10unid.	2,30€

Tampões em Latão PG

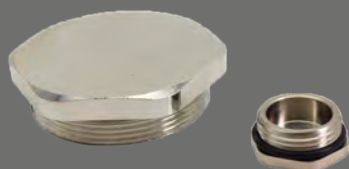

Quantidade mínima venda Saco c/10 Unid.

Código	Rosca	Material	Acab.	Emb. (saco)	P.U.€
SL-TMP07NI	PG 7	Latão	Niquelado	10unid.	1,30€
SL-TMP09NI	PG 9	Latão	Niquelado	10unid.	1,60€
SL-TMP11NI	PG 11	Latão	Niquelado	10unid.	1,70€
SL-TMP09NI	PG 13,5	Latão	Niquelado	10unid.	1,90€
SL-TMP16NI	PG 16	Latão	Niquelado	10unid.	2,20€
SL-TMP21NI	PG 21	Latão	Niquelado	10unid.	3,30€
SL-TMP29NI	PG 29	Latão	Niquelado	10unid.	6,90€
SL-TMP36NI	PG 36	Latão	Niquelado	10unid.	11,00€
SL-TMP42NI	PG 42	Latão	Niquelado	10unid.	14,00€
SL-TMP48NI	PG 48	Latão	Niquelado	10unid.	21,90€

Tampões em Latão Métricos



Quantidade mínima venda Saco c/10 Unid.

Código	Rosca	Material	Acab.	Emb. (saco)	P.U.€
SL-TMM12NI	M12	Latão	Niquelado	10unid.	1,30€
SL-TMM16NI	M16	Latão	Niquelado	10unid.	1,60€
SL-TMM20NI	M20	Latão	Niquelado	10unid.	1,90€
SL-TMM25NI	M25	Latão	Niquelado	10unid.	2,90€
SL-TMM32NI	M32	Latão	Niquelado	10unid.	4,30€
SL-TMM40NI	M40	Latão	Niquelado	10unid.	8,20€
SL-TMM50NI	M50	Latão	Niquelado	10unid.	14,00€
SL-TMM63NI	M63	Latão	Niquelado	10unid.	21,50€

Disponível no 2º Trimestre

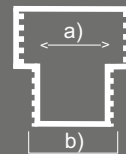
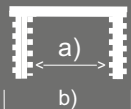

Redução Metálica

Quantidade mínima venda Saco c/10 Unid.

Código	Med.Int. a)	Med.Ext. b)	Emb. (saco)	P.U.€
SL-RMMM-01NI	M16X1,5	M12X1,5	10unid.	1,60€
SL-RMMM-02NI	M20X1,5	M12X1,5	10unid.	1,95€
SL-RMMM-03NI	M20X1,5	M16X1,5	10unid.	1,80€
SL-RMMM-04NI	M25X1,5	M16X1,5	10unid.	3,35€
SL-RMMM-05NI	M25X1,5	M20X1,5	10unid.	2,95€
SL-RMMM-06NI	M32X1,5	M16X1,5	10unid.	6,50€
SL-RMMM-07NI	M32X1,5	M20X1,5	10unid.	5,60€
SL-RMMM-08NI	M32X1,5	M25X1,5	10unid.	5,60€
SL-RMMM-09NI	M40X1,5	M20X1,5	10unid.	9,60€
SL-RMMM-10NI	M40X1,5	M25X1,5	10unid.	9,80€
SL-RMMM-11NI	M40X1,5	M32X1,5	10unid.	9,80€
SL-RMMM-12NI	M50X1,5	M25X1,5	10unid.	16,00€
SL-RMMM-13NI	M50X1,5	M32X1,5	10unid.	16,00€
SL-RMMM-14NI	M50X1,5	M40X1,5	10unid.	16,00€
SL-RMMM-15NI	M63X1,5	M32X1,5	10unid.	24,00€
SL-RMMM-16NI	M63X1,5	M40X1,5	10unid.	24,00€
SL-RMMM-17NI	M63X1,5	M50X1,5	10unid.	24,00€

Ampliação Metálica

Quantidade mínima venda Saco c/10 Unid.

Código	Med.Int. a)	Med.Ext. b)	Emb. (saco)	P.U.€
SL-AMMM-01NI	M12X1,5	M16X1,5	10unid.	1,40€
SL-AMMM-02NI	M12X1,5	M20X1,5	10unid.	2,00€
SL-AMMM-03NI	M16X1,5	M20X1,5	10unid.	2,00€
SL-AMMM-04NI	M16X1,5	M25X1,5	10unid.	3,70€
SL-AMMM-05NI	M16X1,5	M32X1,5	10unid.	7,00€
SL-AMMM-06NI	M20X1,5	M25X1,5	10unid.	3,00€
SL-AMMM-07NI	M20X1,5	M32X1,5	10unid.	6,00€
SL-AMMM-08NI	M20X1,5	M40X1,5	10unid.	9,60€
SL-AMMM-09NI	M25X1,5	M32X1,5	10unid.	5,50€
SL-AMMM-10NI	M25X1,5	M40X1,5	10unid.	9,50€
SL-AMMM-11NI	M25X1,5	M50X1,5	10unid.	18,50€
SL-AMMM-12NI	M32X1,5	M40X1,5	10unid.	8,00€
SL-AMMM-13NI	M32X1,5	M50X1,5	10unid.	17,20€
SL-AMMM-14NI	M32X1,5	M63X1,5	10unid.	23,00€
SL-AMMM-15NI	M40X1,5	M50X1,5	10unid.	15,00€
SL-AMMM-16NI	M40X1,5	M63X1,5	10unid.	21,00€
SL-AMMM-17NI	M50X1,5	M63X1,5	10unid.	20,00€

Redução PG

Quantidade mínima venda Saco c/10 Unid.

Código	Med.Int. a)	Med.Ext. b)	Emb. (saco)	P.U.€
SL-RMPP-01NI	PG 9	PG 7	10unid.	1,10€
SL-RMPP-02NI	PG 11	PG 9	10unid.	1,35€
SL-RMPP-03NI	PG 13,5	PG 7	10unid.	2,5€
SL-RMPP-04NI	PG 13,5	PG 9	10unid.	2,50€
SL-RMPP-05NI	PG 13,5	PG 11	10unid.	1,60€
SL-RMPP-06NI	PG 16	PG 9	10unid.	2,20€
SL-RMPP-07NI	PG 16	PG 11	10unid.	2,70€
SL-RMPP-08NI	PG 16	PG 13,5	10unid.	2,00€
SL-RMPP-09NI	PG 21	PG 11	10unid.	3,80€
SL-RMPP-10NI	PG 21	PG 13,5	10unid.	3,80€
SL-RMPP-11NI	PG 21	PG 16	10unid.	3,10€
SL-RMPP-12NI	PG 29	PG 13,5	10unid.	7,50€
SL-RMPP-13NI	PG 29	PG 16	10unid.	7,00€
SL-RMPP-14NI	PG 29	PG 21	10unid.	5,50€
SL-RMPP-15NI	PG 36	PG 16	10unid.	12,00€
SL-RMPP-16NI	PG 36	PG 21	10unid.	11,50€
SL-RMPP-17NI	PG 36	PG 29	10unid.	11,00€
SL-RMPP-18NI	PG 42	PG 21	10unid.	25,00€
SL-RMPP-19NI	PG 42	PG 29	10unid.	26,00€
SL-RMPP-20NI	PG 42	PG 36	10unid.	21,50€
SL-RMPP-21NI	PG 48	PG 29	10unid.	28,00€
SL-RMPP-22NI	PG 48	PG 36	10unid.	26,00€
SL-RMPP-23NI	PG 48	PG 42	10unid.	27,50€

Ampliação Metálica PG/PG

Quantidade mínima venda Saco c/10 Unid.

Código	Med.Int. a)	Med.Ext. b)	Emb. (saco)	P.U.€
SL-AMPP-01NI	PG 7	PG 9	10unid.	1,60€
SL-AMPP-02NI	PG 9	PG 11	10unid.	1,60€
SL-AMPP-04NI	PG 9	PG 16	10unid.	2,00€
SL-AMPP-06NI	PG 11	PG 13,5	10unid.	2,20€
SL-AMPP-08NI	PG 13,5	PG 16	10unid.	2,60€
SL-AMPP-10NI	PG 16	PG 21	10unid.	4,50€
SL-AMPP-12NI	PG 21	PG 29	10unid.	8,00€
SL-AMPP-14NI	PG 29	PG 36	10unid.	15,00€
SL-AMPP-16NI	PG 36	PG 42	10unid.	22,00€
SL-AMPP-18NI	PG 42	PG 48	10unid.	29,00€

Adaptador PG / Metálica

Quantidade mínima venda Saco c/10 Unid.

Código	Med.Int. a)	Med.Ext. b)	Emb. (saco)	P.U.€
SL-AMPM-01NI	PG 7X1,5	M12X1,5	10unid.	1,60€
SL-AMPM-02NI	PG 9X1,5	M16X1,5	10unid.	2,15€
SL-AMPM-03NI	PG 9X1,5	M20X1,5	10unid.	2,60€
SL-AMPM-04NI	PG 11X1,5	M20X1,5	10unid.	2,80€
SL-AMPM-05NI	PG 11X1,5	M25X1,5	10unid.	4,70€
SL-AMPM-06NI	PG 13,5X1,5	M20X1,5	10unid.	3,00€
SL-AMPM-07NI	PG 13,5X1,5	M25X1,5	10unid.	4,50€
SL-AMPM-08NI	PG 16X1,5	M25X1,5	10unid.	4,50€
SL-AMPM-09NI	PG 16X1,5	M32X1,5	10unid.	8,50€
SL-AMPM-10NI	PG 21X1,5	M32X1,5	10unid.	8,70€
SL-AMPM-11NI	PG 21X1,5	M40X1,5	10unid.	12,00€
SL-AMPM-12NI	PG 29X1,5	M40X1,5	10unid.	12,00€
SL-AMPM-13NI	PG 29X1,5	M50X1,5	10unid.	23,00€
SL-AMPM-14NI	PG 36X1,5	M50X1,5	10unid.	23,00€
SL-AMPM-15NI	PG 42X1,5	M50X1,5	10unid.	21,00€
SL-AMPM-16NI	PG 42X1,5	M63X1,5	10unid.	40,00€
SL-AMPM-17NI	PG 48X1,5	M63X1,5	10unid.	40,00€

Adaptador Metálica / PG

Quantidade mínima venda Saco c/10 Unid.

Código	Med.Int. a)	Med.Ext. b)	Emb. (saco)	P.U.€
SL-AMMP-01NI	M12X1,5	PG 7X1,5	10unid.	1,70€
SL-AMMP-02NI	M16X1,5	PG 9X1,5	10unid.	2,20€
SL-AMMP-03NI	M16X1,5	PG 11X1,5	10unid.	2,60€
SL-AMMP-04NI	M16X1,5	PG 13,5X1,5	10unid.	3,00€
SL-AMMP-05NI	M20X1,5	PG 11X1,5	10unid.	3,20€
SL-AMMP-06NI	M20X1,5	PG 13,5X1,5	10unid.	3,20€
SL-AMMP-07NI	M20X1,5	PG 16X1,5	10unid.	3,30€
SL-AMMP-08NI	M20X1,5	PG 21X1,5	10unid.	4,50€
SL-AMMP-09NI	M25X1,5	PG 13,5X1,5	10unid.	4,60€
SL-AMMP-10NI	M25X1,5	PG 16X1,5	10unid.	4,70€
SL-AMMP-11NI	M25X1,5	PG 21X1,5	10unid.	5,00€
SL-AMMP-12NI	M25X1,5	PG 29X1,5	10unid.	8,50€
SL-AMMP-13NI	M32X1,5	PG 21X1,5	10unid.	8,60€
SL-AMMP-14NI	M32X1,5	PG 29X1,5	10unid.	8,70€
SL-AMMP-15NI	M40X1,5	PG 21X1,5	10unid.	12,00€
SL-AMMP-16NI	M40X1,5	PG 29X1,5	10unid.	12,10€
SL-AMMP-17NI	M50X1,5	PG 36X1,5	10unid.	24,00€
SL-AMMP-18NI	M50X1,5	PG 42X1,5	10unid.	24,00€
SL-AMMP-19NI	M63X1,5	PG 42X1,5	10unid.	36,00€
SL-AMMP-20NI	M63X1,5	PG 48X1,5	10unid.	37,00€

Bucins Ventilados

Disponível no 2º Trimestre



Redução Metálica

Quantidade mínima venda Saco c/10 Unid.

Código	Med.Int. a)	Med.Ext. b)	Emb. (saco)	P.U.€
SL-RPMM-10CZ	M16	M12	10unid.	1,30€
SL-RPMM-20CZ	M20	M16	10unid.	1,20€
SL-RPMM-30CZ	M25	M20	10unid.	1,50€
SL-RPMM-40CZ	M32	M25	10unid.	1,90€



Tampões Ventilados Nylon Métricos

Quantidade mínima venda Saco c/10 Unid.

Código	Rosca	Cor	Acab.	Emb. (saco)	P.U.€
SL-TPMV06CZ	M6X1	Cinza	Nylon	10unid.	1,20€
SL-TPMV08PT	M8X1,25	Cinza	Nylon	10unid.	1,50€
SL-TPMV10CZ	M10X1,5	Cinza	Nylon	10unid.	1,50€
SL-TPMV12CZ	M12X1,5	Cinza	Nylon	10unid.	1,50€
SL-TPMV16CZ	M16X1,5	Cinza	Nylon	10unid.	1,80€



Bucim Latão Niquelado Ventilado

Quantidade mínima venda Saco c/10 Unid.

Código	Rosca	Ø Cabos	Emb. (saco)	P.U.€
SL-BV2007NI	PG 7	3-6,5mm	10unid.	4,50€
SL-BV2009NI	PG 9	4-8mm	10unid.	6,50€
SL-BV2011NI	PG 11	5-10mm	10unid.	7,70€
SL-BV2013NI	PG 13,5	6-12mm	10unid.	8,50€
SL-BV2016NI	PG 16	10-14mm	10unid.	10,00€



Quantidade mínima venda Saco c/10 Unid.

Código	Rosca	Ø Cabos	Emb. (saco)	P.U.€
SL-MV2012NI	M12	3-6,5mm	10unid.	3,25€
SL-MV2016NI	M16	4-8mm	10unid.	6,50€
SL-MV2020NI	M20	6-12mm	10unid.	8,90€
SL-MV2025NI	M25	10-14mm	10unid.	14,70€
SL-MV2032NI	M32	15-22mm	10unid.	21,00€



Quantidade mínima venda Saco c/10 Unid.

Código	Rosca	Material	Acab.	Emb. (saco)	P.U.€
SL-TMMV12NI	M12X1,5	Latão	Niquelado	10unid.	7,70€
SL-TMMV16NI	M16X1,5	Latão	Niquelado	10unid.	12,00€
SL-TMMV20NI	M20X1,5	Latão	Niquelado	10unid.	18,50€

soflight®

Electric

Tubo Flexível PA 6



-40 a 120°C / IP68

Alta resistência ao Impacto e UV

Auto-extinguível, Livre Halogêneos

Resistência a óleos, Gasolina, ácidos e dissolventes





Quantidade Mínima Venda. Rolo completo

Código	PG					Mat. Prima	Cor	Rolo	P.U./mt/€
TPA6-PG7-PT	PG 7	10mm	6,5mm	15mm	50mts	PA 6	Preto	50mts	0,62€/mt
TPA6-PG9-PT	PG 9	13mm	10mm	20mm	50mts	PA 6	Preto	50mts	0,69€/mt
TPA6-PG11-PT	PG 11	16mm	12mm	30mm	50mts	PA 6	Preto	50mts	0,93€/mt
TPA6-PG13-PT	PG 13,5	18,5mm	14mm	40mm	50mts	PA 6	Preto	50mts	1,24€/mt
TPA6-P16-PT	PG 16	21mm	17mm	45mm	50mts	PA 6	Preto	50mts	1,31€/mt
TPA6-PG21-PT	PG 21	28,7mm	23mm	55mm	50mts	PA 6	Preto	50mts	1,95€/mt
TPA6-PG29-PT	PG 29	34,5mm	29mm	65mm	25mts	PA 6	Preto	25mts	2,45€/mt
TPA6-PG36-PT	PG 36	48,5mm	36mm	80mm	25mts	PA 6	Preto	25mts	3,15€/mt
TPA6-PG48-PT	PG 48	54,5mm	48mm	95mm	25mts	PA 6	Preto	25mts	5,30€/mt



Tubo Flexível PA 6 (Aberto)

Quantidade Mínima Venda. Rolo completo

Código	PG					Mat. Prima	Cor	Rolo	P.U./mt/€
TPA6-PG7-PT-A	PG 7	10mm	6,5mm	15mm	50mts	PA 6	Preto	50mts	0,90€/mt
TPA6-PG9-PT-A	PG 9	13mm	10mm	20mm	50mts	PA 6	Preto	50mts	0,95€/mt
TPA6-PG11-PT-A	PG 11	16mm	12mm	30mm	50mts	PA 6	Preto	50mts	1,10€/mt
TPA6-PG13-PT-A	PG 13,5	18,5mm	14mm	40mm	50mts	PA 6	Preto	50mts	1,64€/mt
TPA6-PG16-PT-A	PG 16	21mm	17mm	45mm	50mts	PA 6	Preto	50mts	1,75€/mt
TPA6-PG21-PT-A	PG 21	28,7mm	23mm	55mm	50mts	PA 6	Preto	50mts	2,86€/mt
TPA6-PG29-PT-A	PG 29	34,5mm	29mm	65mm	25mts	PA 6	Preto	25mts	3,65€/mt
TPA6-PG36-PT-A	PG 36	48,5mm	36mm	80mm	25mts	PA 6	Preto	25mts	5,10€/mt
TPA6-PG48-PT-A	PG 48	54,5mm	48mm	95mm	25mts	PA 6	Preto	25mts	6,94€/mt



Bucim PG para Tubo PA6

Quantidade Mínima Venda. Saco completo

Código	Rosca			Rosca ↓	Bucim ↓	Mat. Prima	Cor	Para tubo	Qt/Saco	P.U./€
BTPA6-PG7-PT	PG 7	17mm	13mm	11,5mm	34,5mm	PA 6	Preto	TPA6-PG7	10pcs	0,74€
BTPA6-PG9-PT	PG 9	20mm	16mm	11,5mm	36,5mm	PA 6	Preto	TPA6-PG9	10pcs	0,74€
BTPA6-PG11-PT	PG 11	23mm	19mm	12mm	39,50	PA 6	Preto	TPA6-PG11	10pcs	0,74€
BTPA6-PG13-PT	PG 13,5	26mm	21mm	13mm	42mm	PA 6	Preto	TPA6-PG13,5	10pcs	1,16€
BTPA6-PG16-PT	PG 16	29,5mm	23mm	13mm	45mm	PA 6	Preto	TPA6-P16	10pcs	1,16€
BTPA6-PG21-PT	PG 21	37mm	29mm	13mm	47mm	PA 6	Preto	TPA6-PG21	10pcs	1,45€
BTPA6-PG29-PT	PG 29	44mm	37mm	15mm	51mm	PA 6	Preto	TPA6-PG29	5pcs	2,30€
BTPA6-PG36-PT	PG 36	52mm	47mm	15mm	54mm	PA 6	Preto	TPA6-PG36	5pcs	3,95€
BTPA6-PG48-PT	PG 48	64mm	48mm	16mm	55mm	PA 6	Preto	TPA6-PG48	5pcs	4,90€



Bucim Métrico para Tubo PA6

Quantidade Mínima Venda. Saco completo

Código	Rosca			Rosca ↓	Bucim ↓	Mat. Prima	Cor	Para tubo	Qt/Saco	P.U./€
BTPA6-M12-PT	M12	17mm	12mm	11,5mm	34,5mm	PA 6	Preto	TPA6-PG7	10pcs	0,95€
BTPA6-M16-PT	M16	20mm	16mm	11,5mm	36,5mm	PA 6	Preto	TPA6-PG9	10pcs	0,95€
BTPA6-M16-S-PT	M16	20mm	16mm	11,5mm	36,50	PA 6	Preto	TPA6-PG11	10pcs	1,10€
BTPA6-M20-PT	M20	26mm	20mm	10mm	39,5mm	PA 6	Preto	TPA6-PG13,5	10pcs	1,30€
BTPA6-M20-S-PT	M20	29,5mm	20mm	13mm	45mm	PA 6	Preto	TPA6-P16	10pcs	1,35€
BTPA6-M25-PT	M25	37mm	25mm	13mm	45mm	PA 6	Preto	TPA6-PG21	10pcs	1,80€
BTPA6-M32-PT	M32	44mm	32mm	13mm	47mm	PA 6	Preto	TPA6-PG29	10pcs	2,35€
BTPA6-M40-PT	M40	52mm	40mm	15mm	51mm	PA 6	Preto	TPA6-PG36	5pcs	2,90€
BTPA6-M50-PT	M50	64mm	50mm	15mm	54mm	PA 6	Preto	TPA6-PG48	5pcs	5,30€
BTPA6-M63-PT	M63	64mm	63mm	16mm	55mm	PA 6	Preto	TPA6-PG48	5pcs	8,95€



Abraçadeira para Tubo PA6

Quantidade Mínima Venda. Saco completo

Código		Mat. Prima	Cor	Para tubo	Qt/Saco	P.U./€
ATPA6-M12	10mm	PA 6	Preto	TPA6-PG7	10pcs	0,47€
ATPA6-M16	13mm	PA 6	Preto	TPA6-PG9	10pcs	0,47€
ATPA6-M16-S	16mm	PA 6	Preto	TPA6-PG11	10pcs	0,57€
ATPA6-M20	18,5mm	PA 6	Preto	TPA6-PG13,5	10pcs	0,84€
ATPA6-M20-S	21mm	PA 6	Preto	TPA6-P16	10pcs	0,84€
ATPA6-M25	28,7mm	PA 6	Preto	TPA6-PG21	10pcs	1,15€
ATPA6-M32	34mm	PA 6	Preto	TPA6-PG29	5pcs	1,55€
ATPA6-M40	42mm	PA 6	Preto	TPA6-PG36	5pcs	1,80€
ATPA6-M50	54mm	PA 6	Preto	TPA6-PG48	5pcs	3,10€



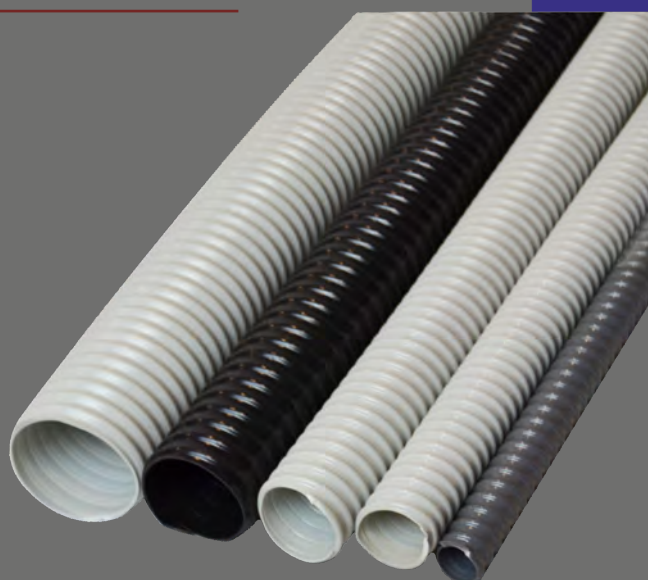

Tubo Flexível PVC

Quantidade Mínima Venda, Rolo completo

Código	PG				Mat. Prima	Cor	P.U.mt/€
TPVC-PG7CZ	PG 7	13,3mm	10mm	30mts	PVC	Cinza	0,70€/mt
TPVC-PG7PT	PG 7	13,3mm	10mm	30mts	PVC	Preto	0,70€/mt
TPVC-PG7AN	PG 7	13,3mm	10mm	30mts	PVC	Antracite	0,70€/mt
TPVC-PG9CZ	PG 9	16mm	12mm	30mts	PVC	Cinza	0,90€/mt
TPVC-PG9PT	PG 9	16mm	12mm	30mts	PVC	Preto	0,90€/mt
TPVC-PG9AN	PG 9	16mm	12mm	30mts	PVC	Antracite	0,90€/mt
TPVC-PG11CZ	PG 11	20mm	16mm	30mts	PVC	Cinza	1,20€/mt
TPVC-PG11PT	PG 11	20mm	16mm	30mts	PVC	Preto	1,20€/mt
TPVC-PG11AN	PG 11	20mm	16mm	30mts	PVC	Antracite	1,20€/mt
TPVC-PG13CZ	PG 13	21,2mm	18mm	30mts	PVC	Cinza	1,35€/mt
TPVC-PG13PT	PG 13	21,2mm	18mm	30mts	PVC	Preto	1,35€/mt
TPVC-PG13AN	PG 13	21,2mm	18mm	30mts	PVC	Antracite	1,35€/mt
TPVC-PG16CZ	PG 16	22,5mm	20mm	30mts	PVC	Cinza	1,67€/mt
TPVC-PG16PT	PG 16	22,5mm	20mm	30mts	PVC	Preto	1,67€/mt
TPVC-PG16AN	PG 16	22,5mm	20mm	30mts	PVC	Antracite	1,67€/mt
TPVC-PG21CZ	PG 21	28,5mm	25mm	30mts	PVC	Cinza	2,05€/mt
TPVC-PG21PT	PG 21	28,5mm	25mm	30mts	PVC	Preto	2,05€/mt
TPVC-PG21AN	PG 21	28,5mm	25mm	30mts	PVC	Antracite	2,05€/mt
TPVC-PG29CZ	PG 29	37mm	32mm	30mts	PVC	Cinza	2,78€/mt
TPVC-PG29PT	PG 29	37mm	32mm	30mts	PVC	Preto	2,78€/mt
TPVC-PG29AN	PG 29	37mm	32mm	30mts	PVC	Antracite	2,78€/mt
TPVC-PG36CZ	PG 36	47mm	40mm	30mts	PVC	Cinza	3,95€/mt
TPVC-PG36PT	PG 36	47mm	40mm	30mts	PVC	Preto	3,95€/mt
TPVC-PG36AN	PG 36	47mm	40mm	30mts	PVC	Antracite	3,95€/mt
TPVC-PG48CZ	PG 48	55,5mm	50mm	30mts	PVC	Cinza	5,70€/mt
TPVC-PG48PT	PG 48	55,5mm	50mm	30mts	PVC	Preto	5,70€/mt
TPVC-PG48AN	PG 48	55,5mm	50mm	30mts	PVC	Antracite	5,70€/mt







Bucim PG para Tubo PVC

Código	Rosca	Mat. Prima	Cor	Para tubo	Qt/Caixa	P.U./€
BTPVC-PG9-CZ	PG 9	PVC	Cinza	TPVC-PG9	1200pcs	1,30€
BTPVC-PG11-CZ	PG 11	PVC	Cinza	TPVC-PG11	800pcs	1,55€
BTPVC-PG16-CZ	PG 16	PVC	Cinza	TPVC-PG16	800pcs	2,00€
BTPVC-PG21-CZ	PG 21	PVC	Cinza	TPVC-PG21	500pcs	2,57€
BTPVC-PG29-CZ	PG 29	PVC	Cinza	TPVC-PG29	160pcs	2,85€

Tubo Flexível Galvanizado revestido PVC



Código	''					Acabamento	P.U./€mt
MFM-01-014	1/4"	14mm	10mm	40mm	50mts	Galvanizado / PVC / Preto	1,45€/mt
MFM-01-038	3/8"	17mm	13mm	45mm	50mts	Galvanizado / PVC / Preto	1,65€/mt
MFM-01-012	1/2"	21mm	16mm	70mm	50mts	Galvanizado / PVC / Preto	1,80€/mt
MFM-01-034	3/4"	26mm	21mm	70mm	25mts	Galvanizado / PVC / Preto	2,05€/mt
MFM-01-100	1"	32mm	26mm	95mm	50mts	Galvanizado / PVC / Preto	2,50€/mt
MFM-01-114	1.1/4"	41mm	35mm	110mm	25mts	Galvanizado / PVC / Preto	3,45€/mt
MFM-01-112	1.1/2"	47mm	40mm	120mm	25mts	Galvanizado / PVC / Preto	5,00€/mt
MFM-01-200	2"	59mm	52mm	180mm	25mts	Galvanizado / PVC / Cinza	6,80€/mt
MFM-01-212	2 1/2"	72mm	63mm	200mm	25mts	Galvanizado / PVC / Cinza	8,95€/mt
MFM-01-300	3"	88mm	78mm	280mm	10mts	Galvanizado / PVC / Cinza	53,00€/mt
MFM-01-400	4"	112mm	102mm	350mm	10mts	Galvanizado / PVC / Cinza	67,50€/mt

Bucins Para Tubo Flexível Galvanizado revestido PVC



Código	''	Acabamento	P.U./€
MFM-03-014	1/4"	Galvanizado	7,90€
MFM-03-038	3/8"	Galvanizado	8,25€
MFM-03-012	1/2"	Galvanizado	10,00€
MFM-03-034	3/4"	Galvanizado	10,60€
MFM-03-100	1"	Galvanizado	12,50€
MFM-03-114	1.1/4"	Galvanizado	24,40€
MFM-03-112	1.1/2"	Galvanizado	36,00€
MFM-03-200	2"	Galvanizado	45,50€
MFM-03-212	2 1/2"	Galvanizado	73,00€
MFM-03-300	3"	Galvanizado	120,00€
MFM-03-400	4"	Galvanizado	230,00€

Topo Para Tubo Flexível Galvanizado revestido PVC

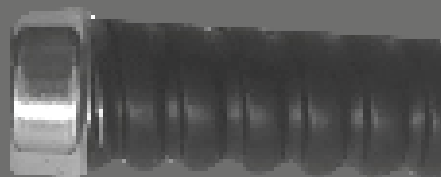

Código	''	Acabamento	P.U./€
MFM-02-014	1/4"	Galvanizado / PVC	1,00€
MFM-02-038	3/8"	Galvanizado / PVC	1,40€
MFM-02-012	1/2"	Galvanizado / PVC	1,50€
MFM-02-034	3/4"	Galvanizado / PVC	1,70€
MFM-02-100	1"	Galvanizado / PVC	2,40€
MFM-02-114	1.1/4"	Galvanizado / PVC	3,50€
MFM-02-112	1.1/2"	Galvanizado / PVC	4,30€
MFM-02-200	2"	Galvanizado / PVC	7,00€
MFM-02-212	2 1/2"	Galvanizado / PVC	13,00€
MFM-02-300	3"	Galvanizado / PVC	25,00€
MFM-02-400	4"	Galvanizado / PVC	30,00€

Tubos / Acessórios D'Áço

soflight®
Electric

Electric Tubo D'Áço Galvanizado

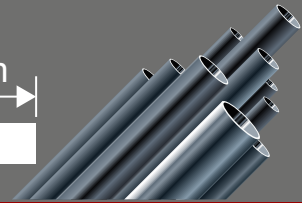
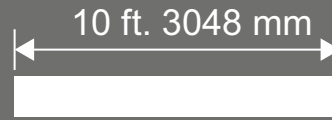
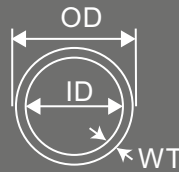

Código	"					Acabamento	P.U./€
TA-01-012	1/2"	17.93mm	15.80mm	1,07mm	3048mm	Galvanizado	4,10€/mt
TA-01-034	3/4"	23.42mm	20.93mm	1,25mm	3048mm	Galvanizado	4,95€/mt
TA-01-100	1"	29.54mm	26.64mm	1,45mm	3048mm	Galvanizado	6,10€/mt
TA-01-114	1.1/4"	38.95mm	35.05mm	1,65mm	3048mm	Galvanizado	9,50€/mt
TA-01-112	1.1/2"	44.20mm	40.89mm	1,65mm	3048mm	Galvanizado	12,50€/mt
TA-01-200	2"	55.80mm	52.50mm	1,65mm	3048mm	Galvanizado	18,80€/mt
TA-01-212	2.1/2"	73.03mm	69.37mm	1,83mm	3048mm	Galvanizado	20,80€/mt

União para Tubo D'Áço Galvanizado



Código	"	A	B	Acabamento	P.U./€
TA-02-012	1/2"	18,50mm	37,00mm	Galvanizado	2,50€
TA-02-034	3/4"	24,00mm	46,00mm	Galvanizado	2,60€
TA-02-100	1"	30,00mm	50,00mm	Galvanizado	3,00€
TA-02-114	1.1/4"	39,50mm	61,00mm	Galvanizado	7,30€
TA-02-112	1.1/2"	45,00mm	69,00mm	Galvanizado	8,60€
TA-02-200	2"	56,50mm	82,00mm	Galvanizado	13,30€
TA-02-212	2.1/2"	74,00mm	102,00mm	Galvanizado	20,00€

Curva 90° para Tubo D'Áço Galvanizado

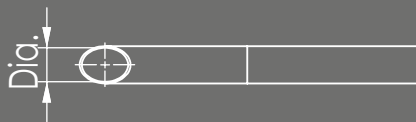
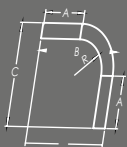

Código	"	R	A	B	C	Acabamento	P.U./€
TA-03-012	1/2"	102mm	38mm	149mm	149mm	Galvanizado	5,20€
TA-03-034	3/4"	114mm	38mm	178mm	178mm	Galvanizado	5,90€
TA-03-100	1"	146mm	48mm	222mm	222mm	Galvanizado	6,30€
TA-03-114	1.1/4"	184mm	51mm	257mm	257mm	Galvanizado	9,30€
TA-03-112	1.1/2"	210mm	51mm	298mm	298mm	Galvanizado	14,80€
TA-03-200	2"	241mm	51mm	356mm	356mm	Galvanizado	27,90€
TA-03-212	2.1/2"	267mm	76mm	413mm	413mm	Galvanizado	36,40€

Topo proteção para tubo D'Áço Galvanizado

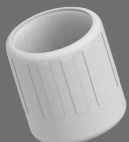

Código	"	Acabamento	P.U./€
TA-04-012	1/2"	PVC	1,25€
TA-04-034	3/4"	PVC	1,40€
TA-04-100	1"	PVC	2,15€
TA-04-114	1.1/4"	PVC	3,20€
TA-04-112	1.1/2"	PVC	3,95€
TA-04-200	2"	PVC	5,50€
TA-04-212	2.1/2"	PVC	10,70€

Curva Tubos para tubo D'Áço Galvanizado



Código	"	Curva Tubos	P.U./€
TA-05-012	1/2"	PVC	155,00€
TA-05-034	3/4"	PVC	210,00€
TA-05-100	1"	PVC	285,00

Manga Expansível Autoextinguível PA

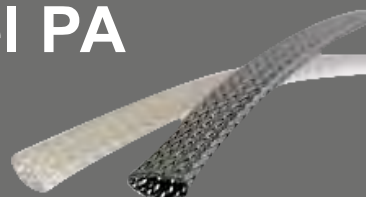

(Quant. Mínima Venda Emb. Completa)

Código	Cor	Diametro	Quantidade Por Caixa	P.U./mt
MEPA6-07CZ	Cinza	3x7mm	100mts	0,32€
MEPA6-12CZ	Cinza	8x12mm	100mts	0,45€
MEPA6-16CZ	Cinza	5x16mm	50mts	0,54€
MEPA6-20CZ	Cinza	8x20mm	50mts	0,64€
MEPA6-25CZ	Cinza	10x25mm	50mts	1,00€
MEPA6-32CZ	Cinza	13x32mm	25mts	1,25€
MEPA6-38CZ	Cinza	16x38mm	25mts	1,45€
MEPA6-44CZ	Cinza	19x44mm	25mts	1,45€
MEPA6-07PT	Preta	3x7mm	100mts	0,32€
MEPA6-12PT	Preta	8x12mm	100mts	0,45€
MEPA6-16PT	Preta	5x16mm	50mts	0,54€
MEPA6-20PT	Preta	8x20mm	50mts	0,64€
MEPA6-25PT	Preta	10x25mm	50mts	1,00€
MEPA6-32PT	Preta	13x32mm	25mts	1,25€
MEPA6-38PT	Preta	16x38mm	25mts	1,45€
MEPA6-44PT	Preta	19x44mm	25mts	1,45€

Fita Espiral



(Quant. Mínima Venda Emb. Completa)

Código	Descrição	Quantidade Por Caixa	P.U./mt
SL-FE-01NA	Fita Espiral 1,5-3mm Natural	50mts	0,27€
SL-FE-02NA	Fita Espiral 4-6mm Natural	25mts	0,33€
SL-FE-03NA	Fita Espiral 6-8mm Natural	25mts	0,49€
SL-FE-04NA	Fita Espiral 9-12mm Natural	20mts	0,72€
SL-FE-01PT	Fita Espiral 1,5-3mm Preta	50mts	0,30€
SL-FE-02PT	Fita Espiral 4-6mm Preta	25mts	0,36€
SL-FE-03PT	Fita Espiral 6-8mm Preta	25mts	0,51€
SL-FE-04PT	Fita Espiral 9-12mm Preta	20mts	0,76€

Manga Expansível Autoextinguível PA



Abraçadeiras de Serrilha

Material: PA6.6

Com Aprovação UL 94V-2

Temperatura trabalho: -30°C / 80°C

(Quant. Mínima Venda/Saco 100 Unid.)

Código	Dimensão	Quant./Emb.	Preço (100 Uni.)
SL-AS100X2,2-BR	100X2,5mm Branca	100	0,58€
SL-AS100X2,2-PT	100X2,2mm Preta	100	0,58€
SL-AS150x2,2-BR	150x2,2mm Branca	100	0,97€
SL-AS150x2,2-PT	150x2,2mm Preta	100	0,97€
SL-AS150x3,0-BR	150x3,0mm Branca	100	1,06€
SL-AS150x3,0-PT	150x3,0mm Preta	100	1,06€
SL-AS200x2,5-BR	200x2,5mm Branca	100	1,50€
SL-AS200x2,5-PT	200x2,5mm Preta	100	1,50€
SL-AS200x3,0-BR	200x3,0mm Branca	100	1,60€
SL-AS200x3,0-PT	200x3,0mm Preta	100	1,60€
SL-AS200x4,0-BR	200x4,0mm Branca	100	1,80€
SL-AS200x4,0-PT	200x4,0mm Preta	100	1,80€
SL-AS250x4,0-BR	250x4,0mm Branca	100	3,85€
SL-AS250x4,0-PT	250x4,0mm Preta	100	3,86€
SL-AS250x7,6-BR	250x7,6mm Branca	100	7,85€
SL-AS250x7,6-PT	250x7,6mm Preta	100	7,85€
SL-AS300x4,0-BR	300x4,0mm Branca	100	4,40€
SL-AS300x4,0-PT	300x4,0mm Preta	100	4,40€
SL-AS300x7,6-BR	300x7,6mm Branca	100	10,00€
SL-AS300x7,6-PT	300x7,6mm Preta	100	10,00€
SL-AS350x7,6-BR	350x7,6mm Branca	100	11,80€
SL-AS350x7,6-PT	350x7,6mm Preta	100	11,80€
SL-AS380x4,3-BR	380x4,3mm Branca	100	6,50€
SL-AS380x4,3-PT	380x4,3mm Preta	100	6,50€
SL-AS400x4,0-BR	400x7,6mm Branca	100	10,00€
SL-AS400x4,0-PT	400x7,6mm Preta	100	10,00€
SL-AS500x12-BR	500x12mm Branca	100	29,00€
SL-AS500x12-PT	500x12mm Preta	100	29,00€
SL-AS750x8,5-BR	750x8,5mm Branca	100	24,00€
SL-AS750x8,5-PT	750x8,5mm Preta	100	24,00€
SL-AS1200x10-BR	1200x10mm Branca	100	40,00€
SL-AS1200x10-PT	1200x10mm Preta	100	40,00€

Plafoniers SOFIA



MINI SOFIA
190mm



SOFIA
295mm

Mini Sofia-Led

eco

soflight®



Plafonier em Resina com Difusor Opalino em PMMA
Bulkhead Resin Material Opal Diffuser, PMMA
220-240Vac, 6W Led 600lm, IP 65

Led: Lâmpada GX53
Led: Bulb GX53

VERSÃO LED / LED VERSION

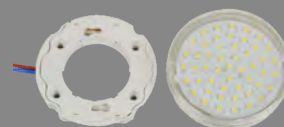

(Incluída)

Mini Sofia-RS Led (Eco)



002.040WOGX53.6.84

LED - 4000K
190x71mm
Branco / White
Emb./Box Qt. 20pcs
P.U. 18,00€

002.040GOGX53.6.84

LED - 4000K
190x71mm
Cinza / Grey
Emb./Box Qt. 20pcs
P.U. 18,00€

002.040BOGX53.6.84

LED - 4000K
190x71mm
Preto / Black
Emb./Box Qt. 20pcs
P.U. 18,00€

002.040AOGX53.6.84

LED - 4000K
190x71mm
Antracite / Dark Grey
Emb./Box Qt. 20pcs
P.U. 19,10€

Mini Sofia-OS Led (Eco)



002.050WOGX53.6.84

LED - 4000K
240x170x71mm
Branco / White
Emb./Box Qt. 20pcs
P.U. 18,00€

002.050GOGX53.6.84

LED - 4000K
240x170x71mm
Cinza / Grey
Emb./Box Qt. 20pcs
P.U. 18,00€

002.050BOGX53.6.84

LED - 4000K
240x170x71mm
Preto / Black
Emb./Box Qt. 20pcs
P.U. 18,00€

002.050AOGX53.6.84

LED - 4000K
240x170x71mm
Antracite / Dark Grey
Emb./Box Qt. 20pcs
P.U. 19,10€

Mini Sofia-QS Led (Eco)



002.060WOGX53.6.84

LED - 4000K
185x185x62mm
Branco / White
Emb./Box Qt. 20pcs
P.U. 20,80€

002.060GOGX53.6.84

LED - 4000K
185x185x62mm
Cinza / Grey
Emb./Box Qt. 20pcs
P.U. 20,80€

002.060BOGX53.6.84

LED - 4000K
185x185x62mm
Preto / Black
Emb./Box Qt. 20pcs
P.U. 20,80€

002.060AOGX53.6.84

LED - 4000K
185x185x62mm
Antracite / Dark Grey
Emb./Box Qt. 20pcs
P.U. 22,50€



Plafonier em Resina com Difusor Opalino em PMMA
Bulkhead Resin Material Opal Diffuser, PMMA
220-240Vac, 7W Led 900lm, IP 65

Led: **OSRAM**

Placa Led 50 000 Horas; 2 Anos Garantia
Led PCB 50 000 Hours; 2 Years Warranty

VERSÃO LED / LED VERSION



(Incluida)

Mini Sofia-RS Led



002.040WO.L15.82

LED - 2700K
190x71mm
Branco / White
Emb./Box Qt. 20pcs
P.U. 39,90€

002.040WO.L15.84

LED - 4000K
190x71mm
Branco / White
Emb./Box Qt. 20pcs
P.U. 39,90€



002.040GO.L15.82

LED - 2700K
190x71mm
Cinza / Grey
Emb./Box Qt. 20pcs
P.U. 39,90€

002.040GO.L15.84

LED - 4000K
190x71mm
Cinza / Grey
Emb./Box Qt. 20pcs
P.U. 39,90€



002.040BO.L15.82

LED - 2700K
190x71mm
Preto / Black
Emb./Box Qt. 20pcs
P.U. 39,90€

002.040BO.L15.84

LED - 4000K
190x71mm
Preto / Black
Emb./Box Qt. 20pcs
P.U. 39,90€



002.040AO.L15.82

LED - 2700K
190x71mm
Antacite / Dark Grey
Emb./Box Qt. 20pcs
P.U. 41,25€

002.040AO.L15.84

LED - 4000K
190x71mm
Antracite / Dark Grey
Emb./Box Qt. 20pcs
P.U. 41,25€

Mini Sofia-OS Led



002.050WO.L15.82

LED - 2700K
240x170x71mm
Branco / White
Emb./Box Qt. 20pcs
P.U. 39,90€

002.050WO.L15.84

LED - 4000K
240x170x71mm
Branco / White
Emb./Box Qt. 20pcs
P.U. 39,90€



002.050GO.L15.82

LED - 2700K
240x170x71mm
Cinza / Grey
Emb./Box Qt. 20pcs
P.U. 39,90€

002.050GO.L15.84

LED - 4000K
240x170x71mm
Cinza / Grey
Emb./Box Qt. 20pcs
P.U. 39,90€



002.050BO.L15.82

LED - 2700K
240x170x71mm
Preto / Black
Emb./Box Qt. 20pcs
P.U. 39,90€

002.050BO.L15.84

LED - 4000K
240x170x71mm
Preto / Black
Emb./Box Qt. 20pcs
P.U. 39,90€



002.050AO.L15.82

LED - 2700K
240x170x71mm
Antacite / Dark Grey
Emb./Box Qt. 20pcs
P.U. 41,25€

002.050AO.L15.84

LED - 4000K
240x170x71mm
Antracite / Dark Grey
Emb./Box Qt. 20pcs
P.U. 41,25€

Mini Sofia-QS Led



002.060WO.L15.82

LED - 2700K
185x185x62mm
Branco / White
Emb./Box Qt. 20pcs
P.U. 42,60€

002.060WO.L15.84

LED - 4000K
185x185x62mm
Branco / White
Emb./Box Qt. 20pcs
P.U. 42,60€



002.060GO.L15.82

LED - 2700K
185x185x62mm
Cinza / Grey
Emb./Box Qt. 20pcs
P.U. 42,60€

002.060GO.L15.84

LED - 4000K
185x185x62mm
Cinza / Grey
Emb./Box Qt. 20pcs
P.U. 42,60€



002.060BO.L15.82

LED - 2700K
185x185x62mm
Preto / Black
Emb./Box Qt. 20pcs
P.U. 42,60€

002.060BO.L15.84

LED - 4000K
185x185x62mm
Preto / Black
Emb./Box Qt. 20pcs
P.U. 42,60€



002.060AO.L15.82

LED - 2700K
185x185x62mm
Antacite / Dark Grey
Emb./Box Qt. 20pcs
P.U. 44,00€

002.060AO.L15.84

LED - 4000K
185x185x62mm
Antracite / Dark Grey
Emb./Box Qt. 20pcs
P.U. 44,00€

Sofia RS/RC-Led

soflight®



Plafonier em Resina com Difusor Opalino em PMMA
Bulkhead Resin Material Opal Diffuser, PMMA
220-240-Vac, 16W Led 1900lm, IP 65

Led: **OSRAM**

Placa Led 50 000 Horas; 2 Anos Garantia
Led PCB 50 000 Hours; 2 Years Warranty

VERSÃO LED / LED VERSION



(Incluida)

Sofia-RS Led



002.010WO.L15.82

LED - 2700K
295x96mm
Branco / White
Emb./Box Qt. 14pcs
P.U. 43,00€

002.010WO.L15.84

LED - 4000K
295x96mm
Branco / White
Emb./Box Qt. 14pcs
P.U. 43,00€



002.010GO.L15.82

LED - 2700K
295x96mm
Cinza / Grey
Emb./Box Qt. 14pcs
P.U. 43,00€

002.010GO.L15.84

LED - 4000K
295x96mm
Cinza / Grey
Emb./Box Qt. 14pcs
P.U. 43,00€



002.010BO.L15.82

LED - 2700K
295x96mm
Preto / Black
Emb./Box Qt. 14pcs
P.U. 43,00€

002.010BO.L15.84

LED - 4000K
295x96mm
Preto / Black
Emb./Box Qt. 14pcs
P.U. 43,00€



002.010AO.L15.82

LED - 2700K
295x96mm
Antacite / Dark Grey
Emb./Box Qt. 14pcs
P.U. 44,00€

002.010AO.L15.84

LED - 4000K
295x96mm
Antracite / Dark Grey
Emb./Box Qt. 14pcs
P.U. 44,00€

Sofia-RC Led



002.011WO.L15.82

LED - 2700K
295x96mm
Branco / White
Emb./Box Qt. 14pcs
P.U. 43,00€

002.011WO.L15.84

LED - 4000K
295x96mm
Branco / White
Emb./Box Qt. 14pcs
P.U. 43,00€



002.011GO.L15.82

LED - 2700K
295x96mm
Cinza / Grey
Emb./Box Qt. 14pcs
P.U. 43,00€

002.011GO.L15.84

LED - 4000K
295x96mm
Cinza / Grey
Emb./Box Qt. 14pcs
P.U. 43,00€



002.011BO.L15.82

LED - 2700K
295x96mm
Preto / Black
Emb./Box Qt. 14pcs
P.U. 43,00€

002.011BO.L15.84

LED - 4000K
295x96mm
Preto / Black
Emb./Box Qt. 14pcs
P.U. 43,00€



002.011AO.L15.82

LED - 2700K
295x96mm
Antacite / Dark Grey
Emb./Box Qt. 14pcs
P.U. 44,00€

002.011AO.L15.84

LED - 4000K
295x96mm
Antracite / Dark Grey
Emb./Box Qt. 14pcs
P.U. 44,00€



Tampa 35° para PlafonierSOFIA Redondo Back cover for Bulkhead SOFIA Round

003.050W035.R Tampa / Back Cover SOFIA-RS/RC (BR/WH)

P.U. 8,50€

003.050B035.R Tampa / Back Cover SOFIA-RS/RC (PT/BK)

P.U. 8,50€

003.050G035.R Tampa / Back Cover SOFIA-RS/RC (CZ/GR)

P.U. 8,50€

003.050A035.R Tampa / Back Cover SOFIA-RS/RC (AN/DG)

P.U. 9,00€

soflight®



Plafonier em Resina com Difusor Opalino em PMMA
Bulkhead Resin Material Opal Diffuser, PMMA
220-240Vac, 16W Led 1900lm, IP 65

Led: **OSRAM**

Placa Led 50 000 Horas; 2 Anos Garantia
Led PCB 50 000 Hours; 2 Years Warranty

Sofia OS/OC-Led

VERSÃO LED / LED VERSION



(Incluída)

Sofia-OS Led

**002.020WO.L15.82**

LED - 2700K
320x230x96mm
Branco / White
Emb./Box Qt. 14pcs
P.U. 43,00€

002.020WO.L15.84

LED - 4000K
320x230x96mm
Branco / White
Emb./Box Qt. 14pcs
P.U. 43,00€

**002.020GO.L15.82**

LED - 2700K
320x230x96mm
Cinza / Grey
Emb./Box Qt. 14pcs
P.U. 43,00€

002.020GO.L15.84

LED - 4000K
320x230x96mm
Cinza / Grey
Emb./Box Qt. 14pcs
P.U. 43,00€

**002.020BO.L15.82**

LED - 2700K
320x230x96mm
Preto / Black
Emb./Box Qt. 14pcs
P.U. 43,00€

002.020BO.L15.84

LED - 4000K
320x230x96mm
Preto / Black
Emb./Box Qt. 14pcs
P.U. 43,00€

**002.020AO.L15.82**

LED - 2700K
320x230x96mm
Antacite / Dark Grey
Emb./Box Qt. 14pcs
P.U. 44,00€

002.020AO.L15.84

LED - 4000K
320x230x96mm
Antracite / Dark Grey
Emb./Box Qt. 14pcs
P.U. 44,00€

Sofia-OC Led

**002.021WO.L15.82**

LED - 2700K
320x230x96mm
Branco / White
Emb./Box Qt. 14pcs
P.U. 43,00€

002.021WO.L15.84

LED - 4000K
320x230x96mm
Branco / White
Emb./Box Qt. 14pcs
P.U. 43,00€

**002.021GO.L15.82**

LED - 2700K
320x230x96mm
Cinza / Grey
Emb./Box Qt. 14pcs
P.U. 43,00€

002.021GO.L15.84

LED - 4000K
320x230x96mm
Cinza / Grey
Emb./Box Qt. 14pcs
P.U. 43,00€

**002.021BO.L15.82**

LED - 2700K
320x230x96mm
Preto / Black
Emb./Box Qt. 14pcs
P.U. 43,00€

002.021BO.L15.84

LED - 4000K
320x230x96mm
Preto / Black
Emb./Box Qt. 14pcs
P.U. 43,00€

**002.021AO.L15.82**

LED - 2700K
320x230x96mm
Antacite / Dark Grey
Emb./Box Qt. 14pcs
P.U. 44,00€

002.021AO.L15.84

LED - 4000K
320x230x96mm
Antracite / Dark Grey
Emb./Box Qt. 14pcs
P.U. 44,00€

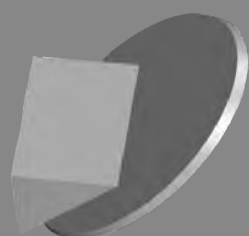

Tampa 35° para Plafonier SOFIA Oval Back cover for Bulkhead SOFIA Oval

003.050W035.O Tampa / Back Cover SOFIA-OS/OC (BR/WH)

P.U. 8,50€

003.050B035.O Tampa / Back Cover SOFIA-OS/OC (PT/BK)

P.U. 8,50€

003.050G035.O Tampa / Back Cover SOFIA-OS/OC (CZ/GR)

P.U. 8,50€

003.050A035.O Tampa / Back Cover SOFIA-OS/OC (AN/DG)

P.U. 9,00€

Sofia QS/QC-Led

soflight®



Plafonier em Resina com Difusor Opalino em PMMA
Bulkhead Resin Material Opal Diffuser, PMMA
220-240Vac, 16W Led 1900lm, IP 65

Led: **OSRAM**

Placa Led 50 000 Horas; 2 Anos Garantia
Led PCB 50 000 Hours; 2 Years Warranty

VERSÃO LED / LED VERSION



(Incluida)

Sofia-QS Led



002.030WO.L15.82

LED - 2700K
295x295x85mm
Branco / White
Emb./Box Qt. 14pcs
P.U. 44,00€

002.030WO.L15.84

LED - 4000K
295x295x85mm
Branco / White
Emb./Box Qt. 14pcs
P.U. 44,00€



002.030GO.L15.82

LED - 2700K
295x295x85mm
Cinza / Grey
Emb./Box Qt. 14pcs
P.U. 44,00€

002.030GO.L15.84

LED - 4000K
295x295x85mm
Cinza / Grey
Emb./Box Qt. 14pcs
P.U. 44,00€



002.030BO.L15.82

LED - 2700K
295x295x85mm
Preto / Black
Emb./Box Qt. 14pcs
P.U. 44,00€

002.030BO.L15.84

LED - 4000K
295x295x85mm
Preto / Black
Emb./Box Qt. 14pcs
P.U. 44,00€



002.030AO.L15.82

LED - 2700K
295x295x85mm
Antacite / Dark Grey
Emb./Box Qt. 14pcs
P.U. 45,00€

002.030AO.L15.84

LED - 4000K
295x295x85mm
Antracite / Dark Grey
Emb./Box Qt. 14pcs
P.U. 45,00€

Sofia-QC Led



002.031WO.L15.82

LED - 2700K
295x295x85mm
Branco / White
Emb./Box Qt. 14pcs
P.U. 44,00€

002.031WO.L15.84

LED - 4000K
295x295x85mm
Branco / White
Emb./Box Qt. 14pcs
P.U. 44,00€



002.031GO.L15.82

LED - 2700K
295x295x85mm
Cinza / Grey
Emb./Box Qt. 14pcs
P.U. 44,00€

002.031GO.L15.84

LED - 4000K
295x295x85mm
Cinza / Grey
Emb./Box Qt. 14pcs
P.U. 44,00€



002.031BO.L15.82

LED - 2700K
295x295x85mm
Preto / Black
Emb./Box Qt. 14pcs
P.U. 44,00€

002.031BO.L15.84

LED - 4000K
295x295x85mm
Preto / Black
Emb./Box Qt. 14cs
P.U. 44,00€



002.031AO.L15.82

LED - 2700K
295x295x85mm
Antacite / Dark Grey
Emb./Box Qt. 14pcs
P.U. 45,00€

002.031AO.L15.84

LED - 4000K
295x295x85mm
Antracite / Dark Grey
Emb./Box Qt. 14pcs
P.U. 45,00€

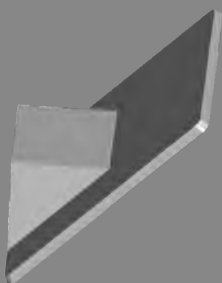

Tampa 35° para Plafonier SOFIA Quadrado Back cover for Bulkhead SOFIA Square

003.050W035.Q Tampa / Back Cover SOFIA-QS/QC (BR/WH)

P.U. 8,50€

003.050B035.Q Tampa / Back Cover SOFIA-QS/QC (PT/BK)

P.U. 8,50€

003.050G035.Q Tampa / Back Cover SOFIA-QS/QC (CZ/GR)

P.U. 8,50€

003.050A035.Q Tampa / Back Cover SOFIA-QS/QC (AN/DG)

P.U. 9,00€

soflight®



Sofia RS/RC-E27

Plafonier em Resina com Difusor Opalino em PMMA
Bulkhead Resin Material Opal Diffuser, PMMA
220-240Vac, Max. 26W - E27 IP 65

VERSÃO E27 / E27 VERSION



(Não Incluída)

Sofia-RS E27

**002.010WO.E27**

E27 - Max. 26W
295x96mm
Branco / White
Emb./Box Qt. 14pcs
P.U. 18,50€

**002.010GO.E27**

E27 - Max. 26W
295x96mm
Cinza / Grey
Emb./Box Qt. 14pcs
P.U. 18,50€

**002.010BO.E27**

E27 - Max- 26W
295x96mm
Preto / Black
Emb./Box Qt. 14pcs
P.U. 18,50€

**002.010AO.E27**

E27 - Max. 26W
295x96mm
Antacite / Dark Grey
Emb./Box Qt. 14pcs
P.U. 19,00€

Sofia-RC E27

**002.011WO.E27**

E27 - Max. 26W
295x96mm
Branco / White
Emb./Box Qt. 14pcs
P.U. 18,50€

**002.011GO.E27**

E27 - Max. 26W
295x96mm
Cinza / Grey
Emb./Box Qt. 14pcs
P.U. 18,50€

**002.011BO.E27**

E27 - Max- 26W
295x96mm
Preto / Black
Emb./Box Qt. 14pcs
P.U. 18,50€

**002.011AO.E27**

E27 - Max. 26W
295x96mm
Antacite / Dark Grey
Emb./Box Qt. 14pcs
P.U. 19,00€

Sofia-OS E27

**002.020WO.E27**

E27 - Max. 26W
320x230x96mm
Branco / White
Emb./Box Qt. 14pcs
P.U. 18,50€

**002.020GO.E27**

E27 - Max. 26W
320x230x96mm
Cinza / Grey
Emb./Box Qt. 14pcs
P.U. 18,50€

**002.020BO.E27**

E27 - Max- 26W
320x230x96mm
Preto / Black
Emb./Box Qt. 14pcs
P.U. 18,50€

**002.020AO.E27**

E27 - Max. 26W
320x230x96mm
Antacite / Dark Grey
Emb./Box Qt. 14pcs
P.U. 19,00€

Sofia-OC E27

**002.021WO.E27**

E27 - Max. 26W
320x230x96mm
Branco / White
Emb./Box Qt. 14pcs
P.U. 18,50€

**002.021GO.E27**

E27 - Max. 26W
320x230x96mm
Cinza / Grey
Emb./Box Qt. 14pcs
P.U. 18,50€

**002.021BO.E27**

E27 - Max- 26W
320x230x96mm
Preto / Black
Emb./Box Qt. 14pcs
P.U. 18,50€

**002.021AO.E27**

E27 - Max. 26W
320x230x96mm
Antacite / Dark Grey
Emb./Box Qt. 14pcs
P.U. 19,00€

Sofia QS/QC-E27

soflight®



VERSÃO E27 / E27 VERSION

Plafonier em Resina com Difusor Opalino em PMMA
Bulkhead Resin Material Opal Diffuser, PMMA
220-240Vac, Max. 2x15W - E27, IP 65



(Não Incluída)

Sofia-QS E27



002.030WO.2E27

E27 - Max. 2x15W
295x295x85mm
Branco / White
Emb./Box Qt. 14pcs
P.U. 24,30€



002.030GO.2E27

E27 - Max. 2x15W
295x295x85mm
Cinza / Grey
Emb./Box Qt. 14pcs
P.U. 24,30€



002.030BO.2E27

E27 - Max. 2x15W
295x295x85mm
Preto / Black
Emb./Box Qt. 14pcs
P.U. 24,30€



002.030AO.2E27

E27 - Max. 2x15W
295x295x85mm
Antracite / Dark Grey
Emb./Box Qt. 14pcs
P.U. 25,50€

Sofia-QC E27



002.031WO.2E27

E27 - Max. 2x15W
295x295x85mm
Branco / White
Emb./Box Qt. 14pcs
P.U. 24,30€



002.031GO.2E27

E27 - Max. 2x15W
295x295x85mm
Cinza / Grey
Emb./Box Qt. 14pcs
P.U. 24,30€



002.031BO.2E27

E27 - Max. 2x15W
295x295x85mm
Preto / Black
Emb./Box Qt. 14pcs
P.U. 24,30€



002.031AO.2E27

E27 - Max. 2x15W
295x295x85mm
Antracite / Dark Grey
Emb./Box Qt. 14pcs
P.U. 25,50€

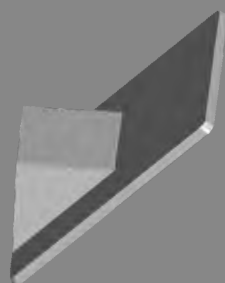

Tampa 35° para Plafonier SOFIA Quadrado Back cover for Bulkhead SOFIA Square

003.050W035.Q Tampa / Back Cover SOFIA-QS/QC (BR/WH)

P.U. 8,50€

003.050B035.Q Tampa / Back Cover SOFIA-QS/QC (PT/BK)

P.U. 8,50€

003.050G035.Q Tampa / Back Cover SOFIA-QS/QC (CZ/GR)

P.U. 8,50€

003.050A035.Q Tampa / Back Cover SOFIA-QS/QC (AN/DG)

P.U. 9,00€

Projetores Espeto

PORTO



Projektor Espeto GU10 Led IP 65
Led Spike GU10 Led IP 65

Porto

VERSÃO LED / LED VERSION

Porto



(Incluída Lâmpada 2700K)



Fornecido sem Lâmpada

007.010.WC.010

Branco / White
Emb./Box Qt. 15pcs
P.U. 37,00€

007.010.GC.010

Cinza / Grey
Emb./Box Qt. 15pcs
P.U. 37,00€

007.010.BC.010

Preto / Black
Emb./Box Qt. 15pcs
P.U. 37,00€

007.010.AC.010

Antracite / Dark Grey
Emb./Box Qt. 15pcs
P.U. 38,00€

Oferta Lâmpada na cor 2700K

007.010.WC.010.82

GU 10-2700K - Max.6W
Com Lâmp. Incluída 3W
Branco / White
Emb./Box Qt. 15pcs
P.U. 37,00€

007.010.GC.010.82

GU10-2700K - Max.6W
Com Lâmp. Incluída 3W
Cinza / Grey
Emb./Box Qt. 15pcs
P.U. 37,00€

007.010.BC.010.82

GU10-2700K - Max.6W
Com Lâmp. Incluída 3W
Preto / Black
Emb./Box Qt. 15pcs
P.U. 37,00€

007.010.AC.010.82

GU10-2700K - Max.6W
Com Lâmp. Incluída 3W
Antracite / Dark Grey
Emb./Box Qt. 15pcs
P.U.38.000€

Projetores Pavimento GIL





Projektor Pavimento GU 10 Led em Resina 220-240Vac
Resin In-Ground Light GU 10 Led 220-240Vac

VERSÃO LED / LED VERSION

Gil 120-Led



(Incluída Lâmpada 2700K)

Fornecido sem Lâmpada

**001.120GC.GU10**

GU 10 - Max. 7W
Diam. Aro 125mm
Caixa 142x74mm
Aro/Ring: Cinza / Grey
Emb./Box Qt. 15pcs
P.U. 36,00€

**001.120BC.GU10**

GU 10 - Max. 7W
Diam. Aro 125mm
Caixa 142x74mm
Aro/Ring: Preto / Black
Emb./Box Qt. 15pcs
P.U. 36,00€

**001.120AC.GU10**

GU 10 - Max. 7W
Diam. Aro 125mm
Caixa 142x74mm
Aro/Ring: Antracite/Dark Grey
Emb./Box Qt. 15pcs
P.U. 36,00€

**001.120SC.GU10**

GU 10 - Max. 7W
Diam. Aro 125mm
Caixa 142x74mm
Aro: Inox
Emb./Box Qt. 15pcs
P.U. 40,00€

**001.125SC.GU10**

GU 10 - Max. 7W
Diam. Aro 125mm
Caixa 142x74mm
Aro: Inox 316
Emb./Box Qt. 15pcs
P.U. 50,00€

Oferta Lâmpada na cor 2700K

001.120GC.GU10.82

GU 10 - Max. 7W
C/Lâmp.Incl. 3W - 2700K
Diam. Aro 125mm
Caixa 142x74mm
Aro/Ring: Cinza / Grey
Emb./Box Qt. 15pcs
P.U. 36,00€

001.120BC.GU10.82

GU 10 - Max. 7W
C/Lâmp.Incl. 3W - 2700K
Diam. Aro 125mm
Caixa 142x74mm
Aro/Ring: Preto / Black
Emb./Box Qt. 15pcs
P.U. 36,00€

001.120AC.GU10.82

GU 10 - Max. 7W
C/Lâmp.Incl. 3W - 2700K
Diam. Aro 125mm
Caixa 142x74mm
Aro/Ring: Antracite/Dark Grey
Emb./Box Qt. 15pcs
P.U. 36,00€

001.120SC.GU10.82

GU 10 - Max. 7W
C/Lâmp.Incl. 3W - 2700K
Diam. Aro 125mm
Caixa 142x74mm
Aro: Inox
Emb./Box Qt. 15pcs
P.U. 40,00€

001.125SC.GU10.82

GU 10 - Max. 7W
C/Lâmp.Incl. 3W - 2700K
Diam. Aro 125mm
Caixa 142x74mm
Aro: Inox 316
Emb./Box Qt. 15pcs
P.U. 50,00€

Fornecido sem Lâmpada

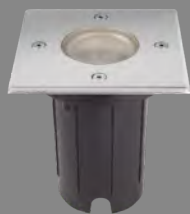
**001.121SC.GU10**

GU 10 - Max. 7W
Diam. Aro 125X125mm
Caixa 142x74mm
Aro/Ring: Inox
Emb./Box Qt. 15pcs
P.U. 45,00€

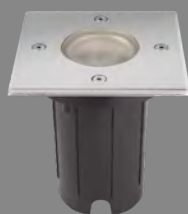
**001.126SC.GU10**

GU 10 - Max. 7W
Diam. Aro 125X125mm
Caixa 142x74mm
Aro/Ring: Inox 316
Emb./Box Qt. 15pcs
P.U. 57,00€

**001.122GC.GU10**

GU 10 - Max. 7W
Diam. Aro 125mm
Caixa 142x74mm
Aro/Ring: Cinza / Grey
Emb./Box Qt. 15pcs
P.U. 38,50€

**001.122BC.GU10**

GU 10 - Max. 7W
Diam. Aro 125mm
Caixa 142x74mm
Aro/Ring: Preto / Black
Emb./Box Qt. 15pcs
P.U. 38,50€

**001.122AC.GU10**

GU 10 - Max. 7W
Diam. Aro 125mm
Caixa 142x74mm
Aro/Ring: Antr. / Dark Grey
Emb./Box Qt. 15pcs
P.U. 39,50€

Oferta Lâmpada na cor 2700K

001.121SC.GU10.82

GU 10 - Max. 7W
C/Lâmp.Incl. 3W - 2700K
Diam. Aro 125X125mm
Caixa 142x74mm
Aro/Ring: Inox
Emb./Box Qt. 15pcs
P.U. 45,00€

001.126SC.GU10.82

GU 10 - Max. 7W
C/Lâmp.Incl. 3W - 2700K
Diam. Aro 125X125mm
Caixa 142x74mm
Aro/Ring: Inox 316
Emb./Box Qt. 15pcs
P.U. 57,00€

001.122GC.GU10.82

GU 10 - Max. 7W
C/Lâmp.Incl. 3W - 2700K
Diam. Aro 125mm
Caixa 142x74mm
Aro/Ring: Cinza / Grey
Emb./Box Qt. 15pcs
P.U. 38,50€

001.122BC.GU10.82

GU 10 - Max. 7W
C/Lâmp.Incl. 3W - 2700K
Diam. Aro 125mm
Caixa 142x74mm
Aro/Ring: Preto / Black
Emb./Box Qt. 15pcs
P.U. 38,50€

001.122AC.GU10.82

GU 10 - Max. 7W
C/Lâmp.Incl. 3W - 2700K
Diam. Aro 125mm
Caixa 142x74mm
Aro/Ring: Antr. / Dark Grey
Emb./Box Qt. 15pcs
P.U. 39,50€

Projektor Pavimento Led em Resina 100-240Vac
Resin In-Ground Light Led 100-240Vac

Led: **OSRAM**

Placa Led 50 000 Horas; 2 Anos Garantia
Led PCB 50 000 Hours; 2 Years Warranty

VERSÃO LED / LED VERSION

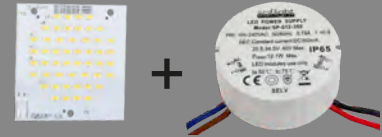

Gil 190-Led



001.190GC.LED.54

LED-12W-1800lm-6000K
Diam. Aro 192mm
Caixa 271x140mm
Aro/Ring: Cinza / Grey
Emb./Box Qt. 8pcs
P.U. 180,00€



001.190BC.LED.54

LED-12W-1800lm-6000K
Diam. Aro 192mm
Caixa 271x140mm
Aro/Ring: Preto / Black
Emb./Box Qt. 8pcs
P.U. 180,00€



001.190AC.LED.54

LED-12W-1800lm-6000K
Diam. Aro 192mm
Caixa 271x140mm
Aro/Ring: Antr. / Dark Grey
Emb./Box Qt. 8pcs
P.U. 182,00€



001.190SC.LED.54

LED-12W-1800lm-6000K
Diam. Aro 192mm
Caixa 271x140mm
Aro/Ring: Inox
Emb./Box Qt. 8pcs
P.U. 215,00€



001.195SC.LED.54

LED-12W-1800lm-6000K
Diam. Aro 192mm
Caixa 271x140mm
Aro/Ring: Inox 316
Emb./Box Qt. 8pcs
P.U. 250,00€

001.190GC.LED.82

LED-12W-1800lm-2700K
Diam. Aro 192mm
Caixa 271x140mm
Aro/Ring: Cinza / Grey
Emb./Box Qt. 8pcs
P.U. 180,00€

001.190BC.LED.82

LED-12W-1800lm-2700K
Diam. Aro 192mm
Caixa 271x140mm
Aro/Ring: Preto / Black
Emb./Box Qt. 8pcs
P.U. 180,00€

001.190AC.LED.82

LED-12W-1800lm-2700K
Diam. Aro 192mm
Caixa 271x140mm
Aro/Ring: Antr. / Dark Grey
Emb./Box Qt. 8pcs
P.U. 182,00€

001.190SC.LED.82

LED-12W-1800lm-2700K
Diam. Aro 192mm
Caixa 271x140mm
Aro/Ring: Inox
Emb./Box Qt. 8pcs
P.U. 215,00€

001.195SC.LED.82

LED-12W-1800lm-2700K
Diam. Aro 192mm
Caixa 271x140mm
Aro/Ring: Inox 316
Emb./Box Qt. 8pcs
P.U. 250,00€

001.190GC.LED.84

LED-12W-1800lm-4000K
Diam. Aro 192mm
Caixa 271x140mm
Aro/Ring: Cinza / Grey
Emb./Box Qt. 8pcs
P.U. 180,00€

001.190BC.LED.84

LED-12W-1800lm-4000K
Diam. Aro 192mm
Caixa 271x140mm
Aro/Ring: Preto / Black
Emb./Box Qt. 8pcs
P.U. 180,00€

001.190AC.LED.84

LED-12W-1800lm-4000K
Diam. Aro 192mm
Caixa 271x140mm
Aro/Ring: Antr. / Dark Grey
Emb./Box Qt. 8pcs
P.U. 182,00€

001.190SC.LED.84

LED-12W-1800lm-4000K
Diam. Aro 192mm
Caixa 271x140mm
Aro/Ring: Inox
Emb./Box Qt. 8pcs
P.U. 215,00€

001.195SC.LED.84

LED-12W-1800lm-4000K
Diam. Aro 192mm
Caixa 271x140mm
Aro/Ring: Inox 316
Emb./Box Qt. 8pcs
P.U. 250,00€



001.191SC.LED.54

LED-12W-1800lm-6000K
Diam. Aro 192x192mm
Caixa 271x140mm
Aro/Ring: Inox
Emb./Box Qt. 8pcs
P.U. 235,00€



001.196SC.LED.54

LED-12W-1800lm-6000K
Diam. Aro 192x192mm
Caixa 271x140mm
Aro/Ring: Inox 316
Emb./Box Qt. 8pcs
P.U. 265,00€



001.192GC.LED.54

LED-12W-1800lm-6000K
Diam. Aro 192mm
Caixa 271x140mm
Aro/Ring: Cinza / Grey
Emb./Box Qt. 8pcs
P.U. 190,00€



001.192BC.LED.54

LED-12W-1800lm-6000K
Diam. Aro 192mm
Caixa 271x140mm
Aro/Ring: Preto / Black
Emb./Box Qt. 8pcs
P.U. 190,00€



001.192AC.LED.54

LED-12W-1800lm-6000K
Diam. Aro 192mm
Caixa 271x140mm
Aro/Ring: Antr./Dark Grey
Emb./Box Qt. 8pcs
P.U. 195,00€

001.191SC.LED.82

LED-12W-1800lm-2700K
Diam. Aro 192x192mm
Caixa 271x140mm
Aro/Ring: Inox
Emb./Box Qt. 8pcs
P.U. 235,00€

001.196SC.LED.82

LED-12W-1800lm-2700K
Diam. Aro 192x192mm
Caixa 271x140mm
Aro/Ring: Inox 316
Emb./Box Qt. 8pcs
P.U. 265,00€

001.192GC.LED.82

LED-12W-1800lm-2700K
Diam. Aro 192mm
Caixa 271x140mm
Aro/Ring: Cinza / Grey
Emb./Box Qt. 8pcs
P.U. 190,00€

001.192BC.LED.82

LED-12W-1800lm-2700K
Diam. Aro 192mm
Caixa 271x140mm
Aro/Ring: Preto / Black
Emb./Box Qt. 8pcs
P.U. 190,00€

001.192AC.LED.82

LED-12W-1800lm-2700K
Diam. Aro 192mm
Caixa 271x140mm
Aro/Ring: Antr./Dark Grey
Emb./Box Qt. 8pcs
P.U. 195,00€

001.191SC.LED.84

LED-12W-1800lm-4000K
Diam. Aro 192x192mm
Caixa 271x140mm
Aro/Ring: Inox
Emb./Box Qt. 8pcs
P.U. 235,00€

001.196SC.LED.84

LED-12W-1800lm-4000K
Diam. Aro 192x192mm
Caixa 271x140mm
Aro/Ring: Inox 316
Emb./Box Qt. 8pcs
P.U. 265,00€

001.192GC.LED.84

LED-12W-1800lm-4000K
Diam. Aro 192mm
Caixa 271x140mm
Aro/Ring: Cinza / Grey
Emb./Box Qt. 8pcs
P.U. 190,00€

001.192BC.LED.84

LED-12W-1800lm-4000K
Diam. Aro 192mm
Caixa 271x140mm
Aro/Ring: Preto / Black
Emb./Box Qt. 8pcs
P.U. 190,00€

001.192AC.LED.84

LED-12W-1800lm-4000K
Diam. Aro 192mm
Caixa 271x140mm
Aro/Ring: Antr./Dark Grey
Emb./Box Qt. 8pcs
P.U. 195,00€

soflight®



Projektor Pavimento Led em Resina 100-240Vac
Resin In-Ground Light Led 100-240Vac

Led: **OSRAM**

Placa Led 50 000 Horas; 2 Anos Garantia
Led PCB 50 000 Hours; 2 Years Warranty

Gil 230-Led

VERSÃO LED / LED VERSION



001.230GC.LED.54

LED-25W-3000lm-6000K
Diam. Aro 228mm
Caixa 265x175mm
Aro/Ring: Cinza / Grey
Emb./Box Qt. 1pcs
P.U. 240,00€



001.230BC.LED.54

LED-25W-3000lm-6000K
Diam. Aro 228mm
Caixa 265x175mm
Aro/Ring: Preto / Black
Emb./Box Qt. 1pcs
P.U. 240,00€



001.230AC.LED.54

LED-25W-3000lm-6000K
Diam. Aro 228mm
Caixa 265x175mm
Aro/Ring: Antr. / Dark Grey
Emb./Box Qt. 1pcs
P.U. 242,00€



001.230SC.LED.54

LED-25W-3000lm-6000K
Diam. Aro 228mm
Caixa 265x175mm
Aro/Ring: Inox
Emb./Box Qt. 1pcs
P.U. 270,00€



001.235SC.LED.54

LED-25W-3000lm-6000K
Diam. Aro 228mm
Caixa 265x175mm
Aro/Ring: Inox 316
Emb./Box Qt. 1pcs
P.U. 295,00€

001.230GC.LED.82

LED-25W-3000lm-2700K
Diam. Aro 228mm
Caixa 265x175mm
Aro/Ring: Cinza / Grey
Emb./Box Qt. 1pcs
P.U. 240,00€

001.230BC.LED.82

LED-25W-3000lm-2700K
Diam. Aro 228mm
Caixa 265x175mm
Aro/Ring: Preto / Black
Emb./Box Qt. 1pcs
P.U. 240,00€

001.230AC.LED.82

LED-25W-3000lm-2700K
Diam. Aro 228mm
Caixa 265x175mm
Aro/Ring: Antr. / Dark Grey
Emb./Box Qt. 1pcs
P.U. 242,00€

001.230SC.LED.82

LED-25W-3000lm-2700K
Diam. Aro 228mm
Caixa 265x175mm
Aro/Ring: Inox
Emb./Box Qt. 1pcs
P.U. 270,00€

001.235SG.LED.82

LED-25W-3000lm-2700K
Diam. Aro 228mm
Caixa 265x175mm
Aro/Ring: Inox 316
Emb./Box Qt. 1pcs
P.U. 295,00€

001.230GC.LED.84

LED-25W-3000lm-4000K
Diam. Aro 228mm
Caixa 265x175mm
Aro/Ring: Cinza / Grey
Emb./Box Qt. 1cs
P.U. 240,00€

001.230BC.LED.84

LED-25W-3000lm-4000K
Diam. Aro 228mm
Caixa 265x175mm
Aro/Ring: Preto / Black
Emb./Box Qt. 1pcs
P.U. 240,00€

001.230AC.LED.84

LED-25W-3000lm-4000K
Diam. Aro 228mm
Caixa 265x175mm
Aro/Ring: Antr. / Dark Grey
Emb./Box Qt. 1pcs
P.U. 242,00€

001.230SC.LED.84

LED-25W-3000lm-4000K
Diam. Aro 228mm
Caixa 265x175mm
Aro/Ring: Inox
Emb./Box Qt. 1pcs
P.U. 270,00€

001.235SG.LED.84

LED-25W-3000lm-4000K
Diam. Aro 228mm
Caixa 265x175mm
Aro/Ring: Inox 316
Emb./Box Qt. 1pcs
P.U. 295,00€

Projektor Pavimento Orientável 25° Redondo 228mm em Resina 100/240 Vac
Resin In-Ground light 228mm 100/240 Vac

Gil 230-Led Orientável

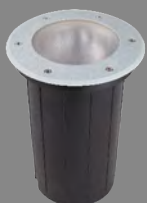

001.231GC.LED.54

LED-12W-1800lm-6000K
Diam. Aro 228mm
Caixa 265x175mm
Aro/Ring: Cinza / Grey
Emb./Box Qt. 1pcs
P.U. 240,00€



001.231BC.LED.54

LED-12W-1800lm-6000K
Diam. Aro 228mm
Caixa 265x175mm
Aro/Ring: Preto / Black
Emb./Box Qt. 1pcs
P.U. 240,00€



001.231AC.LED.54

LED-12W-1800lm-6000K
Diam. Aro 228mm
Caixa 265x175mm
Aro/Ring: Antr. / Dark Grey
Emb./Box Qt. 1pcs
P.U. 245,00€



001.231SC.LED.54

LED-12W-1800lm-6000K
Diam. Aro 228mm
Caixa 265x175mm
Aro/Ring: Inox
Emb./Box Qt. 1pcs
P.U. 270,00€



001.237SC.LED.54

LED-12W-1800lm-6000K
Diam. Aro 228mm
Caixa 265x175mm
Aro/Ring: Inox 316
Emb./Box Qt. 1pcs
P.U. 296,00€

001.231GC.LED.82

LED-12W-1800lm-2700K
Diam. Aro 228mm
Caixa 265x175mm
Aro/Ring: Cinza / Grey
Emb./Box Qt. 1pcs
P.U. 240,00€

001.231BC.LED.82

LED-12W-1800lm-2700K
Diam. Aro 228mm
Caixa 265x175mm
Aro/Ring: Preto / Black
Emb./Box Qt. 1pcs
P.U. 240,00€

001.231AC.LED.82

LED-12W-1800lm-2700K
Diam. Aro 228mm
Caixa 265x175mm
Aro/Ring: Antr. / Dark Grey
Emb./Box Qt. 1pcs
P.U. 245,00€

001.231SC.LED.82

LED-12W-1800lm-2700K
Diam. Aro 228mm
Caixa 265x175mm
Aro/Ring: Inox
Emb./Box Qt. 1pcs
P.U. 270,00€

001.237SC.LED.82

LED-12W-1800lm-2700K
Diam. Aro 228mm
Caixa 265x175mm
Aro/Ring: Inox 316
Emb./Box Qt. 1pcs
P.U. 296,00€

001.231GC.LED.84

LED-12W-1800lm-4000K
Diam. Aro 228mm
Caixa 265x175mm
Aro/Ring: Cinza / Grey
Emb./Box Qt. 1pcs
P.U. 240,00€

001.231BC.LED.84

LED-12W-1800lm-4000K
Diam. Aro 228mm
Caixa 265x175mm
Aro/Ring: Preto / Black
Emb./Box Qt. 1pcs
P.U. 240,00€

001.231AC.LED.84

LED-12W-1800lm-4000K
Diam. Aro 228mm
Caixa 265x175mm
Aro/Ring: Antr. / Dark Grey
Emb./Box Qt. 1pcs
P.U. 245,00€

001.231SC.LED.84

LED-12W-1800lm-4000K
Diam. Aro 228mm
Caixa 265x175mm
Aro/Ring: Inox
Emb./Box Qt. 1pcs
P.U. 270,00€

001.237SC.LED.84

LED-12W-1800lm-4000K
Diam. Aro 228mm
Caixa 265x175mm
Aro/Ring: Inox 316
Emb./Box Qt. 1pcs
P.U. 296,00€

Gil 190/230-E27

soflight®



VERSÃO E27 / E27 VERSION

Projektor Pavimento E27 em Resina 220-240Vac
Resin In-Ground Light E27 220-240Vac



(Não Incluída)

Gil 190-E27



001.190GC.E27

E27 - Max. 20W
Diam. Aro 192mm
Caixa 271x140mm
Aro/Ring: Cinza / Grey
Emb./Box Qt. 8pcs
P.U. 64,00€



001.190BC.E27

E27 - Max. 20W
Diam. Aro 192mm
Caixa 271x140mm
Aro/Ring: Preto / Black
Emb./Box Qt. 8pcs
P.U. 64,00€



001.190AC.E27

E27 - Max. 20W
Diam. Aro 192mm
Caixa 271x140mm
Aro/Ring: Antr. / Dark Grey
Emb./Box Qt. 8pcs
P.U. 65,00€



001.190SC.E27

E27 - 20W
Diam. Aro 192mm
Caixa 271x140mm
Aro/Ring: Inox
Emb./Box Qt. 8pcs
P.U. 79,00€



001.195SC.E27

E27 - Max. 20W
Diam. Aro 192mm
Caixa 271x140mm
Aro/Ring: Inox 316
Emb./Box Qt. 8pcs
P.U. 92,50€

Gil 190-E27



001.192GC.E27

E27 - Max. 20W
Diam. Aro 192mm
Caixa 271x140mm
Aro/Ring: Cinza / Grey
Emb./Box Qt. 8pcs
P.U. 66,00€



001.192BC.E27

E27 - Max. 20W
Diam. Aro 192mm
Caixa 271x140mm
Aro/Ring: Preto / Black
Emb./Box Qt. 8pcs
P.U. 66,00€



001.192AC.E27

E27 - Max. 20W
Diam. Aro 192mm
Caixa 271x140mm
Aro/Ring: Antr. / Dark Grey
Emb./Box Qt. 8pcs
P.U. 68,00€



001.191SC.E27

E27 - Max. 20W
Diam. Aro 192x192mm
Caixa 271x140mm
Aro/Ring: Inox
Emb./Box Qt. 8pcs
P.U. 90,00€



001.196SC.E27

E27 - Max. 20W
Diam. Aro 192x192mm
Caixa 271x140mm
Aro/Ring: Inox 316
Emb./Box Qt. 8pcs
P.U. 110,00€

Projektor Pavimento 228mm E27 em Resina 240Vac
Resin In-Ground Light 228mm E27 240Vac

Gil 230-E27

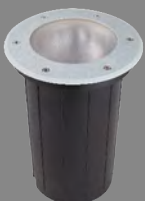

001.230GC.E27

E27 - Max. 20W
Diam. Aro 228mm
Caixa 265x175mm
Aro/Ring: Cinza / Grey
Emb./Box Qt. 1pcs
P.U. 75,00€



001.230BC.E27

E27 - Max. 20W
Diam. Aro 228mm
Caixa 265x175mm
Aro/Ring: Preto / Black
Emb./Box Qt. 1pcs
P.U. 75,00€



001.230AC.E27

E27 - Max. 20W
Diam. Aro 228mm
Caixa 265x175mm
Aro/Ring: Antr. / Dark Grey
Emb./Box Qt. 1pcs
P.U. 77,00€



001.230SC.E27

E27 - Max. 20W
Diam. Aro 228mm
Caixa 265x175mm
Aro/Ring: Inox
Emb./Box Qt. 1pcs
P.U. 110,00€



001.235SC.E27

E27 - Max. 20W
Diam. Aro 228mm
Caixa 265x175mm
Aro/Ring: Inox 316
Emb./Box Qt. 1pcs
P.U. 145,00€

Apliques Muro CLARA



Aplique Muro em Resina com Difusor Opalino em PMMA, 220-240Vac
Resin Recessed Wall, Opal Diffuser, PMMA, 220-240Vac

VERSÃO LED / LED VERSION

Led: OSRAM

Placa Led 50 000 Horas; 2 Anos Garantia
Led PCB 50 000 Hours; 2 Years Warranty

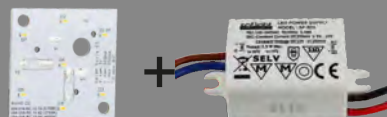

(Incluída)

Clara 85-Led

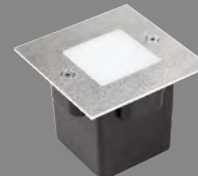
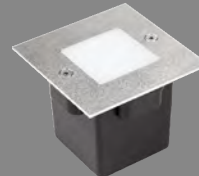
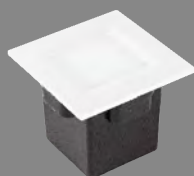

004.011.WO.LED-82

LED-2W-250lm-2700K
Aro/Ring 85X85mm
Cx/Box: 78x78x66mm
Aro/Ring: Branco / White
Emb./Box Qt. 20pcs
P.U. 34,00€

004.011.GO.LED-82

LED-2W-250lm-2700K
Aro/Ring 85X85mm
Cx/Box: 78x78x66mm
Aro/Ring: Cinza / Grey
Emb./Box Qt. 20pcs
P.U. 34,00€

004.011.BO.LED-82

LED-2W-250lm-2700K
Aro/Ring 85X85mm
Cx/Box: 78x78x66mm
Aro/Ring: Preto / Black
Emb./Box Qt. 20pcs
P.U. 34,00€

004.011.AO.LED-82

LED-2W-250lm-2700K
Aro/Ring 85X85mm
Cx/Box: 78x78x66mm
Aro/Ring: Antr./Dark Grey
Emb./Box Qt. 20pcs
P.U. 35,00€

004.011.SO.LED-82

LED-2W-250lm-2700K
Aro/Ring 85X85mm
Cx/Box: 78x78x66mm
Aro/Ring: Inox
Emb./Box Qt. 20pcs
P.U. 41,00€

004.017.SO.LED-82

LED-2W-250lm-2700K
Aro/Ring 85X85mm
Cx/Box: 78x78x66mm
Aro/Ring: Inox 316
Emb./Box Qt. 20pcs
P.U. 44,00€

004.011.WO.LED-84

LED-2W-250lm-4000K
Aro/Ring 85x85mm
Cx/Box: 78x78x66mm
Aro/Ring: Branco / White
Emb./Box Qt. 20pcs
P.U. 34,00€

004.011.GO.LED-84

LED-2W-250lm-4000K
Aro/Ring 85x85mm
Cx/Box: 78x78x66mm
Aro/Ring: Cinza / Grey
Emb./Box Qt. 20pcs
P.U. 34,00€

004.011.BO.LED-84

LED-2W-250lm-4000K
Aro/Ring 85x85mm
Cx/Box: 78x78x66mm
Aro/Ring: Preto / Black
Emb./Box Qt. 20pcs
P.U. 34,00€

004.011.AO.LED-84

LED-2W-250lm-4000K
Aro/Ring 85x85mm
Cx/Box: 78x78x66mm
Aro/Ring: Antr./Dark Grey
Emb./Box Qt. 20pcs
P.U. 35,00€

004.011.SO.LED-84

LED-2W-250lm-4000K
Aro/Ring 85x85mm
Cx/Box: 78x78x66mm
Aro/Ring: Inox
Emb./Box Qt. 20pcs
P.U. 41,00€

004.017.SO.LED-84

LED-2W-250lm-4000K
Aro/Ring 85x85mm
Cx/Box: 78x78x66mm
Aro/Ring: Inox 316
Emb./Box Qt. 20pcs
P.U. 44,00€

Clara 97-Led

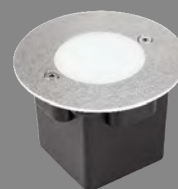
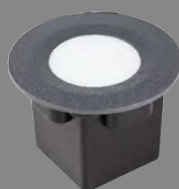

004.021.WO.LED-82

LED-2W-250lm-2700K
Aro/Ring 97mm
Cx/Box: 78x78x66mm
Aro/Ring: Branco / White
Emb./Box Qt. 20pcs
P.U. 34,00€

004.021.GO.LED-82

LED-2W-250lm-2700K
Aro/Ring 97mm
Cx/Box: 78x78x66mm
Aro/Ring: Cinza / Grey
Emb./Box Qt. 20pcs
P.U. 34,00€

004.021.BO.LED-82

LED-2W-250lm-2700K
Aro/Ring 97mm
Cx/Box: 78x78x66mm
Aro/Ring: Preto / Black
Emb./Box Qt. 20pcs
P.U. 34,00€

004.021.AO.LED-82

LED-2W-250lm-2700K
Aro/Ring 97mm
Cx/Box: 78x78x66mm
Aro/Ring: Antr./Dark Grey
Emb./Box Qt. 20pcs
P.U. 35,00€

004.021.SO.LED-82

LED-2W-250lm-2700K
Aro/Ring 97mm
Cx/Box: 78x78x66mm
Aro/Ring: Inox
Emb./Box Qt. 20pcs
P.U. 41,00€

004.027.SO.LED-82

LED-2W-250lm-2700K
Aro/Ring 97mm
Cx/Box: 78x78x66mm
Aro/Ring: Inox 316
Emb./Box Qt. 20pcs
P.U. 44,00€

004.021.WO.LED-84

LED-2W-250lm-4000K
Aro/Ring 97mm
Cx/Box: 78x78x66mm
Aro/Ring: Branco / White
Emb./Box Qt. 20pcs
P.U. 34,00€

004.021.GO.LED-84

LED-2W-250lm-4000K
Aro/Ring 97mm
Cx/Box: 78x78x66mm
Aro/Ring: Cinza / Grey
Emb./Box Qt. 20pcs
P.U. 34,00€

004.021.BO.LED-84

LED-2W-250lm-4000K
Aro/Ring 97mm
Cx/Box: 78x78x66mm
Aro/Ring: Preto / Black
Emb./Box Qt. 20pcs
P.U. 34,00€

004.021.AO.LED-84

LED-2W-250lm-4000K
Aro/Ring 97mm
Cx/Box: 78x78x66mm
Aro/Ring: Antr./Dark Grey
Emb./Box Qt. 20pcs
P.U. 35,00€

004.021.SO.LED-84

LED-2W-250lm-4000K
Aro/Ring 97mm
Cx/Box: 78x78x66mm
Aro/Ring: Inox
Emb./Box Qt. 20pcs
P.U. 41,00€

004.027.SO.LED-84

LED-2W-250lm-4000K
Aro/Ring 97mm
Cx/Box: 78x78x66mm
Aro/Ring: Inox 316
Emb./Box Qt. 20pcs
P.U. 44,00€



VERSÃO LED / LED VERSION

Aplique Muro em Resina com Difusor Opalino em PMMA, 220-240Vac
Resin Recessed Wall, Opal Diffuser, PMMA, 220-240Vac

Led: **OSRAM**

Placa Led 50 000 Horas; 2 Anos Garantia

Led PCB 50 000 Hours; 2 Years Warranty



(Incluída)

Clara 170-Led



004.031.WO.LED-82	004.031.GO.LED-82	004.031.BO.LED-82	004.031.AO.LED-82	004.031.SO.LED-82	004.037.SO.LED-82
LED-2,1W-300lm-2700K Aro/Ring 163x78mm Cx/Box:156x72x66mm Aro/Ring: Branco / White Emb./Box Qt. 20pcs P.U. 37,00€	LED-2,1W-300lm-2700K Aro/Ring 163X78mm Cx/Box:156X72X66mm Aro/Ring: Cinza / Grey Emb./Box Qt. 20pcs P.U. 37,00€	LED-2,1W-300lm-2700K Aro/Ring 163X78mm Cx/Box:156X72X66mm Aro/Ring: Preto / Black Emb./Box Qt. 20pcs P.U. 37,00€	LED-2,1W-300lm-2700K Aro/Ring 163X78mm Cx/Box:156X72X66mm Aro/Ring: Ant./Dark Grey Emb./Box Qt. 20pcs P.U. 39,00€	LED-2,1W-300lm-2700K Aro/Ring 163X78mm Cx/Box:156X72X66mm Aro/Ring: Inox Emb./Box Qt. 20pcs P.U. 45,00€	LED-2,1W-300lm-2700K Aro/Ring 163X78mm Cx/Box:156X72X66mm Aro/Ring: Inox 316 Emb./Box Qt. 20pcs P.U. 49,00€

004.031.WO.LED-84	004.031.GO.LED-84	004.031.BO.LED-84	004.031.AO.LED-84	004.031.SO.LED-84	004.037.SO.LED-84
LED-2,1W-300lm-4000K Aro/Ring 163x78mm Cx/Box 156x72x66mm Aro/Ring: Branco / White Emb./Box Qt. 20pcs P.U. 37,00€	LED-2,1W-300lm-4000K Aro/Ring 163X78mm Cx/Box 156X72X66mm Aro/Ring: Cinza / Grey Emb./Box Qt. 20pcs P.U. 37,00€	LED-2,1W-300lm-4000K Aro/Ring 163X78mm Cx/Box 156X72X66mm Aro/Ring: Preto / Black Emb./Box Qt. 20pcs P.U. 37,00€	LED-2,1W-300lm-4000K Aro/Ring 163X78mm Cx/Box 156X72X66mm Aro/Ring:Ant./Dark Grey Emb./Box Qt. 20pcs P.U. 39,00€	LED-2,1W-300lm-4000K Aro/Ring 163X78mm Cx/Box 156X72X66mm Aro/Ring: Inox Emb./Box Qt. 20pcs P.U. 45,00€	LED-2,1W-300lm-4000K Aro/Ring 163X78mm Cx/Box 156X72X66mm Aro/Ring: Inox 316 Emb./Box Qt. 20pcs P.U. 49,00€

Clara 245-E27 / Led

soflight®



Aplique Muro em Resina com Difusor Opalino em PMMA, 220-240Vac
Resin Recessed Wall, Opal Diffuser, PMMA, 220-240Vac

VERSÃO E27 / E27 VERSION

Clara 245 - E27

(Caixa/negativo (004.049.B.O.CX) não Incluída)



(Não Incluída)

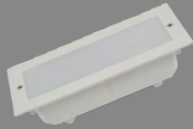

004.040.WO.E27

E27 - Max.15W
Aro/Ring 248x106mm
Cx/Box:224,5x84x69mm
Aro/Ring: Branco / White
Emb./Box Qt. 20pcs
P.U. 17,00€

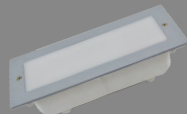

004.040.GO.E27

E27 - Max. 15W
Aro/Ring 248x106mm
Cx/Box:224,5x84x69mm
Aro/Ring: Cinza / Grey
Emb./Box Qt. 20pcs
P.U. 17,00€

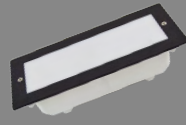

004.040.BO.E27

E27 - Max. 15W
Aro/Ring 248x106mm
Cx/Box:224,5x84x69mm
Aro/Ring: Preto / Black
Emb./Box Qt. 20pcs
P.U. 17,00€

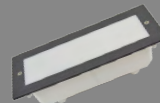

004.040.AO.E27

E27 - Max. 15W
Aro/Ring 248x106mm
Cx/Box:224,5x84x69mm
Aro/Ring: Ant./Dark Grey
Emb./Box Qt. 20pcs
P.U. 18,00€

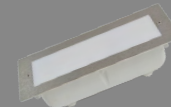

004.040.SO.E27

E27 - Max. 15W
Aro/Ring 250x110mm
Cx/Box:224,5x84x69mm
Aro/Ring: Inox
Emb./Box Qt. 20pcs
P.U. 22,00€

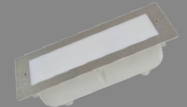

004.045.SO.E27

E27 - Max.15W
Aro/Ring 250x110mm
Cx/Box:224,5x84x69mm
Aro/Ring: Inox 316
Emb./Box Qt. 20pcs
P.U. 28,00€

Led: **OSRAM**

Placa Led 50 000 Horas; 2 Anos Garantia
Led PCB 50 000 Hours; 2 Years Warranty

VERSÃO LED / LED VERSION



(Incluída)

Clara 245 - Led

(Caixa/negativo (004.049.B.O.CX) não Incluída)

004.040.WO.LED.82

5,5W-810lm-2700K
Aro/Ring 248x106mm
Cx/Box:224,5x84x69mm
Aro/Ring: Branco / White
Emb./Box Qt. 20pcs
P.U. 32,00€

004.040.GO.LED.82

5,5W-810lm-2700K
Aro/Ring 248x106mm
Cx/Box:224,5x84x69mm
Aro/Ring: Cinza / Grey
Emb./Box Qt. 20pcs
P.U. 32,00€

004.040.BO.LED.82

5,5W-810lm-2700K
Aro/Ring 248x106mm
Cx/Box:224,5x84x69mm
Aro/Ring: Preto / Black
Emb./Box Qt. 20pcs
P.U. 32,00€

004.040.AO.LED.82

5,5W-810lm-2700K
Aro/Ring 248x106mm
Cx/Box:224,5x84x69mm
Aro/Ring: Ant./Dark Grey
Emb./Box Qt. 20pcs
P.U. 33,00€

004.040.SO.LED.82

5,5W-810lm-2700K
Aro/Ring 250x110mm
Cx/Box:224,5x84x69mm
Aro/Ring: Inox
Emb./Box Qt. 20pcs
P.U. 41,00€

004.045.SO.LED.82

5,5W-810lm-2700K
Aro/Ring 250x110mm
Cx/Box:224,5x84x69mm
Aro/Ring: Inox 316
Emb./Box Qt. 20pcs
P.U. 50,00€

004.040.WO.LED.84

5,5W-810lm-4000K
Aro/Ring 248x106mm
Cx/Box:224,5x84x69mm
Aro/Ring: Branco / White
Emb./Box Qt. 20pcs
P.U. 32,00€

004.040.GO.LED.84

5,5W-810lm-4000K
Aro/Ring 248x106mm
Cx/Box:224,5x84x69mm
Aro/Ring: Cinza / Grey
Emb./Box Qt. 20pcs
P.U. 32,00€

004.040.BO.LED.84

5,5W-810lm-4000K
Aro/Ring 248x106mm
Cx/Box:224,5x84x69mm
Aro/Ring: Preto / Black
Emb./Box Qt. 20pcs
P.U. 32,00€

004.040.AO.LED.84

5,5W 810lm-4000K
Aro/Ring 248x106mm
Cx/Box:224,5x84x69mm
Aro/Ring: Ant./Dark Grey
Emb./Box Qt. 20pcs
P.U. 33,00€

004.040.SO.LED.84

5,5W-810lm-4000K
Aro/Ring 250x110mm
Cx/Box:224,5x84x69mm
Aro/Ring: Inox
Emb./Box Qt. 20pcs
P.U. 41,00€

004.045.SO.LED.84

5,5W-810lm-4000K
Aro/Ring 250x110mm
Cx/Box:224,5x84x69mm
Aro/Ring: Inox 316
Emb./Box Qt. 20pcs
P.U. 50,00€

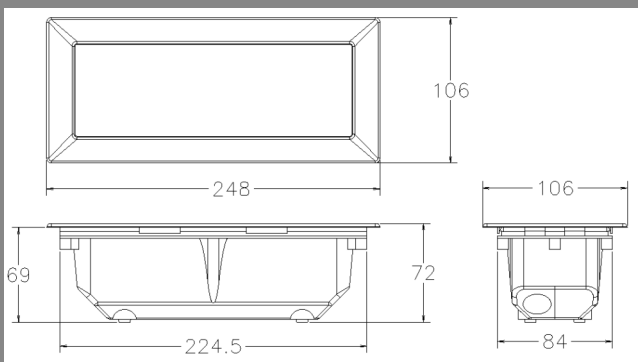

004.049.B.O.CX

Caixa para Aplique Muro
Clara 245
Emb./Box Qt. 150 pcs
P.U. 1,80€

soflight®



Clara 300-E27 / Led

VERSÃO LED / LED VERSION

Aplique Muro em Resina com Difusor Opalino em PMMA, 220-240Vac
Resin Recessed Wall, Opal Diffuser, PMMA, 220-240Vac

Led: **OSRAM**

Placa Led 50 000 Horas; 2 Anos Garantia
Led PCB 50 000 Hours; 2 Years Warranty



(Incluída)

Clara 300-Led



004.050.WO.L15.82	004.050.GO.L15.82	004.050.BO.L15.82	004.050.AO.L15.82	004.050.SO.L15.82	004.055.SO.L15.82
6,5W-1000lm-2700K Aro/Ring 294x124mm Cx/Box:282x112x97mm Aro/Ring: Branco / White Emb./Box Qt. 21pcs P.U. 39,00€	6,5W-1000lm-2700K Aro/Ring 294x124mm Cx/Box:282x112x97mm Aro/Ring: Cinza / Grey Emb./Box Qt. 21pcs P.U. 39,00€	6,5W-1000lm-2700K Aro/Ring 294x124mm Cx/Box:282x112x97mm Aro/Ring: Preto / Black Emb./Box Qt. 21pcs P.U. 39,00€	6,5W-1000lm-2700K Aro/Ring 294x124mm Cx/Box:282x112x97mm Aro/Ring: Ant./Dark Grey Emb./Box Qt. 21pcs P.U. 40,00€	6,5W-1000lm-2700K Aro/Ring 294x124mm Cx/Box:282x112x97mm Aro/Ring: Inox Emb./Box Qt. 21pcs P.U. 47,00€	6,5W-1000lm-2700K Aro/Ring 294x124mm Cx/Box:282x112x97mm Aro/Ring: Inox 316 Emb./Box Qt. 21pcs P.U. 55,00€
004.050.WO.L15.84	004.050.GO.L15.84	004.050.BO.L15.84	004.050.AO.L15.84	004.050.SO.L15.84	004.055.SO.L15.84
6,5W-1000lm-4000K Aro/Ring 294x124mm Cx/Box 282x112x97mm Aro/Ring: Branco / White Emb./Box Qt. 21pcs P.U. 39,00€	6,5W-1000lm-4000K Aro/Ring 294x124mm Cx/Box 282x112x97mm Aro/Ring: Cinza / Grey Emb./Box Qt. 21pcs P.U. 39,00€	6,5-1000lm-4000K Aro/Ring 294x124mm Cx/Box 282x112x97mm Aro/Ring: Preto / Black Emb./Box Qt. 21pcs P.U. 39,00€	6,5W-1000lm-4000K Aro/Ring 294x124mm Cx/Box 282x112x97mm Aro/Ring: Ant./Dark Grey Emb./Box Qt. 21pcs P.U. 40,00€	6,5W-1000lm-4000K Aro/Ring 294x124mm Cx/Box 282x112x97mm Aro/Ring: Inox Emb./Box Qt. 21pcs P.U. 47,00€	6,5W-1000lm-4000K Aro/Ring 294x124mm Cx/Box 282x112x97mm Aro/Ring: Inox 316 Emb./Box Qt. 21pcs P.U. 55,00€

Aplique Muro em Resina E27, Max. 26W com Difusor Opalino em PMMA
Resin Recessed Wall E27, Opal Diffuser, PMMA

VERSÃO E27 / E27 VERSION

(Sem Lâmpada)

Clara 300-E27



004.050.WO.E27	004.050.GO.E27	004.050.BO.E27	004.050.AO.E27	004.050.SO.E27	004.055.SO.E27
E27 - Max.26w - 4200K Aro/Ring 294x124mm Cx/Box:282x112x97mm Aro/Ring: Branco / White Emb./Box Qt. 21pcs P.U. 20,50€	E27 - Max.26w - 4200K Aro/Ring 294x124mm Cx/Box:282x112x97mm Aro/Ring: Cinza / Grey Emb./Box Qt. 21pcs P.U. 20,50€	E27 - Max.26W - 4200K Aro/Ring 294x124mm Cx/Box:282x112x97mm Aro/Ring: Preto / Black Emb./Box Qt. 21pcs P.U. 20,50€	E27 - Max.26W - 4200K Aro/Ring 294x124mm Cx/Box:282x112x97mm Aro/Ring: Ant./Dark Grey Emb./Box Qt. 21pcs P.U. 22,00€	E27 - Max.26W - 4200K Aro/Ring 294x124mm Cx/Box:282x112x97mm Aro/Ring: Inox Emb./Box Qt. 21pcs P.U. 26,00€	E27 - Max.26W - 4200K Aro/Ring 294x124mm Cx/Box:282x112x97mm Aro/Ring: Inox 316 Emb./Box Qt. 21pcs P.U. 43,00€

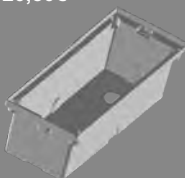

004.059.B.O.CX

Cx. p/Aplique Clara 300
Cx/Box:282x112x97mm
Cor: Preto
Emb./Box Qt. 21pcs
P.U. 2,55€

Balizadores Redondos ZEZA-RD





(Não Incluída)

Balizador Redondo em Resina , Difusor PMMA
Round Bollard Resin Material , Diffuser PMMA



003.210WO.E27

Balizador redondo S/Lâmp.
Base: 116mm
Diam.90mm/Alt.286mm
Cor: Branco / White
Difusor: Opalino/Opal
Emb./Box Qt. 1pcs
P.U. 30,00€



003.210GO.E27

Balizador redondo S/Lâmp.
Base: 116mm
Diam.90mm/Alt.286mm
Cor: Cinza / Grey
Difusor: Opalino/Opal
Emb./Box Qt. 1pcs
P.U. 30,00€



003.210BO.E27

Balizador redondo S/Lâmp.
Base: 116mm
Diam.90mm/Alt.286mm
Cor: Preto / Black
Difusor: Opalino/Opal
Emb./Box Qt. 1pcs
P.U. 30,00€



003.210AO.E27

Balizador redondo S/Lâmp.
Base: 116mm
Diam.90mm/Alt.286mm
Cor: Antracite / Dark Grey
Difusor: Opalino/Opal
Emb./Box Qt. 1pcs
P.U. 31,00€



003.220WO.E27

Balizador redondo S/Lâmp.
Base: 116mm
Diam.90mm/Alt.411mm
Cor: Branco / White
Difusor: Opalino/Opal
Emb./Box Qt. 1pcs
P.U. 35,00€



003.220GO.E27

Balizador redondo S/Lâmp.
Base: 116mm
Diam.90mm/Alt.411mm
Cor: Cinza / Grey
Difusor: Opalino/Opal
Emb./Box Qt. 1pcs
P.U. 35,00€



003.220BO.E27

Balizador redondo S/Lâmp.
Base: 116mm
Diam.90mm/Alt.411mm
Cor: Preto / Black
Difusor: Opalino/Opal
Emb./Box Qt. 1pcs
P.U. 35,00€



003.220AO.E27

Balizador redondo S/Lâmp.
Base: 116mm
Diam.90mm/Alt.411mm
Cor: Antracite / Dark Grey
Difusor: Opalino/Opal
Emb./Box Qt. 1pcs
P.U. 36,00€



003.230WO.E27

Balizador redondo S/Lâmp.
Base: 116mm
Diam.90mm/Alt.581mm
Cor: Branco / White
Difusor: Opalino/Opal
Emb./Box Qt. 1pcs
P.U. 40,00€



003.230GO.E27

Balizador redondo S/Lâmp.
Base: 116mm
Diam.90mm/Alt.581mm
Cor: Cinza / Grey
Difusor: Opalino/Opal
Emb./Box Qt. 1pcs
P.U. 40,00€



003.230BO.E27

Balizador redondo S/Lâmp.
Base: 116mm
Diam.90mm/Alt.581mm
Cor: Preto / Black
Difusor: Opalino/Opal
Emb./Box Qt. 1pcs
P.U. 40,00€



003.230AO.E27

Balizador redondo S/Lâmp.
Base: 116mm
Diam.90mm/Alt.581mm
Cor: Antracite / Dark Grey
Difusor: Opalino/Opal
Emb./Box Qt. 1pcs
P.U. 42,00€



003.240WO.E27

Balizador redondo S/Lâmp.
Base: 116mm
Diam.90mm/Alt.290mm
Cor: Branco / White
Difusor: Opalino/Opal
Emb./Box Qt. 1pcs
P.U. 39,00€

003.240GO.E27

Balizador redondo S/Lâmp.
Base: 116mm
Diam.90mm/Alt.290mm
Cor: Cinza / Grey
Difusor: Opalino/Opal
Emb./Box Qt. 1pcs
P.U. 39,00€

003.240BO.E27

Balizador redondo S/Lâmp.
Base: 116mm
Diam.90mm/Alt.290mm
Cor: Preto / Black
Difusor: Opalino/Opal
Emb./Box Qt. 1pcs
P.U. 39,00€

003.240AO.E27

Balizador redondo S/Lâmp.
Base: 116mm
Diam.90mm/Alt.290mm
Cor: Antracite / Dark Grey
Difusor: Opalino/Opal
Emb./Box Qt. 1pcs
P.U. 41,00€

Zeza 500 RD

Balizador Redondo 470mm em Resina , Difusor PMMA, Max.20W
Round Bollard 470mm Resin Material , Diffuser PMMA, Max.20W

VERSÃO LED / LED VERSION

VERSÃO E27 / E27 VERSION

3X



(Não Incluídas)



(Não Incluída)



003.110WO.E27

E27 - Max. 20W
Base: 220mm
Diam.142mm/Alt.470mm
Cor: Branco / White
Difusor: Opalino/Opal
Emb./Box Qt. 1pcs
P.U. 90,00€



003.110GO.E27

E27 - Max. 20W
Base: 220mm
Diam.142mm/Alt.470mm
Cor: Cinza/Grey
Difusor: Opalino/Opal
Emb./Box Qt. 1pcs
P.U. 90,00€



003.110BO.E27

E27 - Max. 20W
Base: 220mm
Diam.142mm/Alt.470mm
Cor: Preto/Black
Difusor: Opalino/Opal
Emb./Box Qt. 1pcs
P.U. 90,00€



003.110AO.E27

E27 - Max. 20W
Base: 220mm
Diam.142mm/Alt.470mm
Cor: Antra. /Dark Grey
Difusor: Opalino/Opal
Emb./Box Qt. 1pcs
P.U. 92,00€



003.110WO.3GU10

LED-3xGU10-Max.12W
Base: 220mm
Diam.142mm/Alt.470mm
Cor: Branco / White
Difusor: Opalino/Opal
Emb./Box Qt. 1pcs
P.U. 105,00€



003.110GO.3GU10

LED-3xGU10-Max 12W
Base: 220mm
Diam.142mm/Alt.470mm
Cor: Cinza/Grey
Difusor: Opalino/Opal
Emb./Box Qt. 1pcs
P.U. 105,00€



003.110BO.3GU10

LED-3xGU10-Max12W
Base: 220mm
Diam.142mm/Alt.470mm
Cor: Preto/Black
Difusor: Opalino/Opal
Emb./Box Qt. 1pcs
P.U. 105,00€



003.110AO.3GU10

LED-3xGU10-Max.12W
Base: 220mm
Diam.142mm/Alt.470mm
Cor: Antrite /Dark Grey
Difusor: Opalino/Opal
Emb./Box Qt. 1pcs
P.U. 107,00€



003.110WC.3GU10

LED-3xGU10-Max.12W
Base: 220mm
Diam.142mm/Alt.470mm
Cor: Branco / White
Difusor: Transp./Clear
Emb./Box Qt. 1pcs
P.U. 105,00€



003.110GC.3GU10

LED-3xGU10-Max.12W
Base: 220mm
Diam.142mm/Alt.470mm
Cor: Cinza/Grey
Difusor: Transp./Clear
Emb./Box Qt. 1pcs
P.U. 105,00€



003.110BC.3GU10

LED-3xGU10-Max. 12W
Base: 220mm
Diam.142mm/Alt.470mm
Cor: Preto/Black
Difusor: Transp./Clear
Emb./Box Qt. 1pcs
P.U. 105,00€



003.110AC.3GU10

LED-3xGU10-Max.12W
Base: 220mm
Diam.142mm/Alt.470mm
Cor: Antrac. /Dark Grey
Difusor: Transp./Clear
Emb./Box Qt. 1pcs
P.U. 107,00€

Zeza 90° RD

Balizador Redondo 90° em Resina , Difusor PMMA
Round Bollard 90° Resin Material , Diffuser PMMA



003.140WO.E27

E27 - Max. 20W
Base: 220mm
Diam.142mm/Alt.522mm
Cor: Branco / White
Difusor: Opalino/Opal
Emb./Box Qt. 1pcs
P.U. 91,00€



003.140GO.E27

E27 - Max. 20W
Base: 220mm
Diam.142mm/Alt.522mm
Cor: Cinza/Grey
Difusor: Opalino/Opal
Emb./Box Qt. 1pcs
P.U. 91,00€



003.140BO.E27

E27 - Max. 20W
Base: 220mm
Diam.142mm/Alt.522mm
Cor: Preto/Black
Difusor: Opalino/Opal
Emb./Box Qt. 1pcs
P.U. 91,00€



003.140AO.E27

E27 - Max. 20W
Base: 220mm
Diam.142mm/Alt.522mm
Cor: Antrac. /Dark Grey
Difusor: Opalino/Opal
Emb./Box Qt. 1pcs
P.U. 93,00€



003.140WO.3GU10

LED-3xGU10-Max.12W
Base: 220mm
Diam.142mm/Alt.522mm
Cor: Branco / White
Difusor: Opalino/Opal
Emb./Box Qt. 1pcs
P.U. 106,00€



003.140GO.3GU10

LED-3xGU10-Max.12W
Base: 220mm
Diam.142mm/Alt.522mm
Cor: Cinza/Grey
Difusor: Opalino/Opal
Emb./Box Qt. 1pcs
P.U. 106,00€



003.140BO.3GU10

LED-3xGU10-Max.12W
Base: 220mm
Diam.142mm/Alt.522mm
Cor: Preto/Black
Difusor: Opalino/Opal
Emb./Box Qt. 1pcs
P.U. 106,00€



003.140AO.3GU10

LED-3xGU10-Max.12W
Base: 220mm
Diam.142mm/Alt.522mm
Cor: Antrac. /Dark Grey
Difusor: Opalino/Opal
Emb./Box Qt. 1pcs
P.U. 108,00€



003.140WC.3GU10

LED-3xGU10-Max.12W
Base: 220mm
Diam.142mm/Alt.522mm
Cor: Branco / White
Difusor: Transp./Clear
Emb./Box Qt. 1pcs
P.U. 106,00€



003.140GC.3GU10

LED-3xGU10-Max.12W
Base: 220mm
Diam.142mm/Alt.522mm
Cor: Cinza/Grey
Difusor: Transp./Clear
Emb./Box Qt. 1pcs
P.U. 106,00€



003.140BC.3GU10

LED-3xGU10-Max.12W
Base: 220mm
Diam.142mm/Alt.522mm
Cor: Preto/Black
Difusor: Transp./Clear
Emb./Box Qt. 1pcs
P.U. 106,00€



003.140AC.3GU10

LED-3xGU10-Max.12W
Base: 220mm
Diam.142mm/Alt.522mm
Cor: Antrac. /Dark Grey
Difusor: Transp./Clear
Emb./Box Qt. 1pcs
P.U. 108,00€

Zeza 800 RD

Balizador Redondo 770mm em Resina, Difusor PMMA, Max.20W
 Round Bollard 770mm Resin Material, Diffuser PMMA, Max.20W

VERSÃO LED / LED VERSION

VERSÃO E27 / E27 VERSION



(Não Incluídas)



(Não Incluída)



003.120WO.E27
 E27 - Max. 20W
 Base: 220mm
 Diam.142mm/Alt.770mm
 Cor: Branco / White
 Difusor: Opalino/Opal
 Emb./Box Qt. 1pcs
 P.U. 98,00€



003.120GO.E27
 E27 - Max. 20W
 Base: 220mm
 Diam.142mm/Alt.770mm
 Cor: Cinza/Grey
 Difusor: Opalino/Opal
 Emb./Box Qt. 1pcs
 P.U. 98,00€



003.120BO.E27
 E27 - Max. 20W
 Base: 220mm
 Diam.142mm/Alt.770mm
 Cor: Preto/Black
 Difusor: Opalino/Opal
 Emb./Box Qt. 1pcs
 P.U. 98,00€



003.120AO.E27
 E27 - Max. 20W
 Base: 220mm
 Diam.142mm/Alt.770mm
 Cor: Antrac. /Dark Grey
 Difusor: Opalino/Opal
 Emb./Box Qt. 1pcs
 P.U. 100,00€



003.120WO.3GU10
 LED-3xGU10-Max.12W
 Base: 220mm
 Diam.142mm/Alt.770mm
 Cor: Branco / White
 Difusor: Opalino/Opal
 Emb./Box Qt. 1pcs
 P.U. 112,00€



003.120GO.3GU10
 LED-3xGU10-Max.12W
 Base: 220mm
 Diam.142mm/Alt.770mm
 Cor: Cinza/Grey
 Difusor: Opalino/Opal
 Emb./Box Qt. 1pcs
 P.U. 112,00€



003.120BO.3GU10
 LED-3xGU10-Max.12W
 Base: 220mm
 Diam.142mm/Alt.770mm
 Cor: Preto/Black
 Difusor: Opalino/Opal
 Emb./Box Qt. 1pcs
 P.U. 112,00€



003.120AO.3GU10
 LED-3xGU10-Max.12W
 Base: 220mm
 Diam.142mm/Alt.770mm
 Cor: Antrac. /Dark Grey
 Difusor: Opalino/Opal
 Emb./Box Qt. 1pcs
 P.U. 114,00€



003.120WC.3GU10
 LED-3xGU10-Max.12W
 Base: 220mm
 Diam.142mm/Alt.770mm
 Cor: Branco / White
 Difusor: Transp./Clear
 Emb./Box Qt. 1pcs
 P.U. 112,00€



003.120GC.3GU10
 LED-3xGU10-Max.12W
 Base: 220mm
 Diam.142mm/Alt.770mm
 Cor: Cinza/Grey
 Difusor: Transp./Clear
 Emb./Box Qt. 1pcs
 P.U. 112,00€



003.120BC.3GU10
 LED-3xGU10-Max.12W
 Base: 220mm
 Diam.142mm/Alt.770mm
 Cor: Preto/Black
 Difusor: Transp./Clear
 Emb./Box Qt. 1pcs
 P.U. 112,00€



003.120AC.3GU10
 LED-3xGU10-Max.12W
 Base: 220mm
 Diam.142mm/Alt.770mm
 Cor: Antrac. /Dark Grey
 Difusor: Transp./Clear
 Emb./Box Qt. 1pcs
 P.U. 114,00€

Zeza 1100 RD

Balizador Redondo 1070mm em Resina, Difusor PMMA
 Round Bollard 1070mm Resin Material, Diffuser PMMA



003.130WO.E27
 E27 - Max. 20W
 Base: 220mm
 Diam142mm/Alt.1070mm
 Cor: Branco / White
 Difusor: Opalino/Opal
 Emb./Box Qt. 1pcs
 P.U. 110,00€



003.130GO.E27
 E27 - Max. 20W
 Base: 220mm
 Diam142mm/Alt.1070mm
 Cor: Cinza/Grey
 Difusor: Opalino/Opal
 Emb./Box Qt. 1pcs
 P.U. 110,00€



003.130BO.E27
 E27 - Max. 20W
 Base: 220mm
 Diam142mm/Alt.1070mm
 Cor: Preto/Black
 Difusor: Opalino/Opal
 Emb./Box Qt. 1pcs
 P.U. 110,00€



003.130AO.E27
 E27 - Max. 20W
 Base: 220mm
 Diam142mm/Alt.1070mm
 Cor: Antrac./Dark Grey
 Difusor: Opalino/Opal
 Emb./Box Qt. 1pcs
 P.U. 114,00€



003.130WO.3GU10
 LED-3xGU10-Max.12W
 Base: 220mm
 Diam142mm/Alt.1070mm
 Cor: Branco / White
 Difusor: Opalino/Opal
 Emb./Box Qt. 1pcs
 P.U. 125,00€



003.130GO.3GU10
 LED-3xGU10-Max.12W
 Base: 220mm
 Diam142mm/Alt.1070mm
 Cor: Cinza/Grey
 Difusor: Opalino/Opal
 Emb./Box Qt. 1pcs
 P.U. 125,00€



003.130BO.3GU10
 LED-3xGU10-Max.12W
 Base: 220mm
 Diam142mm/Alt.1070mm
 Cor: Preto/Black
 Difusor: Opalino/Opal
 Emb./Box Qt. 1pcs
 P.U. 125,00€



003.130AO.3GU10
 LED-3xGU10-Max.12W
 Base: 220mm
 Diam142mm/Alt.1070mm
 Cor: Antrac. /Dark Grey
 Difusor: Opalino/Opal
 Emb./Box Qt. 1pcs
 P.U. 125,00€



003.130WC.3GU10
 LED-3xGU10-Max.12W
 Base: 220mm
 Diam142mm/Alt.1070mm
 Cor: Branco / White
 Difusor: Transp./Clear
 Emb./Box Qt. 1pcs
 P.U. 125,00€



003.130GC.3GU10
 LED-3xGU10-Max.12W
 Base: 220mm
 Diam142mm/Alt.1070mm
 Cor: Cinza/Grey
 Difusor: Transp./Clear
 Emb./Box Qt. 1pcs
 P.U. 125,00€



003.130BC.3GU10
 LED-3xGU10-Max.12W
 Base: 220mm
 Diam142mm/Alt.1070mm
 Cor: Preto/Black
 Difusor: Transp./Clear
 Emb./Box Qt. 1pcs
 P.U. 125,00€



003.130AC.3GU10
 LED-3xGU10-Max.12W
 Base: 220mm
 Diam142mm/Alt.1070mm
 Cor: Antrac. /Dark Grey
 Difusor: Transp./Clear
 Emb./Box Qt. 1pcs
 P.U. 128,00€

Balizadores Quadrados

ZEZA-SQ



soflight®



Zeza-SQ

Zeza 500 SQ

Balizador Quadrado 770mm em Resina, Difusor PMMA, Max.20W
Square Bollard 770mm Resin Material, Diffuser PMMA, Max.20W

VERSÃO LED / LED VERSION

VERSÃO E27 / E27 VERSION



(Não Incluídas)



(Não Incluída)

**003.010WO.E27**E27 - Max. 20W
Base: 220mm
Diam. 142mm/Alt.470mm
Cor: Branco / White
Difusor: Opalino/Opal
Emb./Box Qt. 1pcs
P.U. 90,00€**003.010GO.E27**E27 - Max. 20W
Base: 220mm
Diam. 142mm/Alt.470mm
Cor: Cinza/Grey
Difusor: Opalino/Opal
Emb./Box Qt. 1pcs
P.U. 90,00€**003.010BO.E27**E27 - Max. 20W
Base: 220mm
Diam. 142mm/Alt.470mm
Cor: Preto/Black
Difusor: Opalino/Opal
Emb./Box Qt. 1pcs
P.U. 90,00€**003.010AO.E27**E27 - Max. 20W
Base: 220mm
Diam. 142mm/Alt.470mm
Cor: Antrac. /Dark Grey
Difusor: Opalino/Opal
Emb./Box Qt. 1pcs
P.U. 92,00€**003.010WO.4GU10**4xGU10-Max. 12W
Base: 220mm
Diam. 142mm/Alt.470mm
Cor: Branco / White
Difusor: Opalino/Opal
Emb./Box Qt. 1pcs
P.U. 105,00€**003.010GO.4GU10**4xGU10-Max. 12W
Base: 220mm
Diam. 142mm/Alt.470mm
Cor: Cinza/Grey
Difusor: Opalino/Opal
Emb./Box Qt. 1pcs
P.U. 105,00€**003.010BO.4GU10**4xGU10-Max. 12W
Base: 220mm
Diam. 142mm/Alt.470mm
Cor: Preto/Black
Difusor: Opalino/Opal
Emb./Box Qt. 1pcs
P.U. 105,00€**003.010AO.4GU10**4xGU10-Max. 12W
Base: 220mm
Diam. 142mm/Alt.470mm
Cor: Antrac. /Dark Grey
Difusor: Opalino/Opal
Emb./Box Qt. 1pcs
P.U. 108,00€

Zeza 90° SQ

Balizador Quadrado 90° em Resina, Difusor PMMA
Square Bollard 90° Resin Material, Diffuser PMMA**003.040WO.E27**E27 - Max. 20W
Base: 220mm
Diam. 142mm/Alt.522mm
Cor: Branco / White
Difusor: Opalino/Opal
Emb./Box Qt. 1pcs
P.U. 91,00€**003.040GO.E27**E27 - Max. 20W
Base: 220mm
Diam. 142mm/Alt.522mm
Cor: Cinza/Grey
Difusor: Opalino/Opal
Emb./Box Qt. 1pcs
P.U. 91,00€**003.040BO.E27**E27 - Max. 20W
Base: 220mm
Diam. 142mm/Alt.522mm
Cor: Preto/Black
Difusor: Opalino/Opal
Emb./Box Qt. 1pcs
P.U. 91,00€**003.040AO.E27**E27 - Max. 20W
Base: 220mm
Diam. 142mm/Alt.522mm
Cor: Antrac. /Dark Grey
Difusor: Opalino/Opal
Emb./Box Qt. 1pcs
P.U. 93,00€**003.040WO.4GU10**4xGU10-Max. 12W
Base: 220mm
Diam. 142mm/Alt.522mm
Cor: Branco / White
Difusor: Opalino/Opal
Emb./Box Qt. 1pcs
P.U. 106,00€**003.040GO.4GU10**4xGU10-Max. 12W
Base: 220mm
Diam. 142mm/Alt.522mm
Cor: Cinza/Grey
Difusor: Opalino/Opal
Emb./Box Qt. 1pcs
P.U. 106,00€**003.040BO.4GU10**4xGU10-Max. 12W
Base: 220mm
Diam. 142mm/Alt.522mm
Cor: Preto/Black
Difusor: Opalino/Opal
Emb./Box Qt. 1pcs
P.U. 106,00€**003.040AO.4GU10**4xGU10-Max. 12W
Base: 220mm
Diam. 142mm/Alt.522mm
Cor: Antrac. /Dark Grey
Difusor: Opalino/Opal
Emb./Box Qt. 1pcs
P.U. 108,00€

Zeza 800 SQ

Balizador Quadrado 770mm em Resina, Difusor PMMA, Max. 20W
Square Bollard 770mm Resin Material, Diffuser PMMA, Max.20W

VERSÃO LED / LED VERSION

VERSÃO E27 / E27 VERSION



(Não Incluídas)



(Não Incluída)



003.020WO.E27

E27 - Max. 20W
Base: 220mm
Diam.142mm/Alt.770mm
Cor: Branco / White
Difusor: Opalino/Opal
Emb./Box Qt. 1pcs
P.U. 98,00€



003.020GO.E27

E27 - Max. 20W
Base: 220mm
Diam.142mm/Alt.770mm
Cor: Cinza/Grey
Difusor: Opalino/Opal
Emb./Box Qt. 1pcs
P.U. 98,00€



003.020BO.E27

E27 - Max. 20W
Base: 220mm
Diam.142mm/Alt.770mm
Cor: Preto/Black
Difusor: Opalino/Opal
Emb./Box Qt. 1pcs
P.U. 98,00€



003.020AO.E27

E27 - Max. 20W
Base: 220mm
Diam.142mm/Alt.770mm
Cor: Antrac. /Dark Grey
Difusor: Opalino/Opal
Emb./Box Qt. 1pcs
P.U. 101,00€



003.020WO.4GU10

LED-4xGU10-Max.12W
Base: 220mm
Diam.142mm/Alt.770mm
Cor: Branco / White
Difusor: Opalino/Opal
Emb./Box Qt. 1pcs
P.U. 112,00€



003.020GO.4GU10

LED-4xGU10-Max.12W
Base: 220mm
Diam.142mm/Alt.770mm
Cor: Cinza/Grey
Difusor: Opalino/Opal
Emb./Box Qt. 1pcs
P.U. 112,00€



003.020BO.4GU10

LED-4xGU10-Max.12W
Base: 220mm
Diam.142mm/Alt.770mm
Cor: Preto/Black
Difusor: Opalino/Opal
Emb./Box Qt. 1pcs
P.U. 112,00€



003.020AO.4GU10

LED-4xGU10-Max.12W
Base: 220mm
Diam.142mm/Alt.770mm
Cor: Antrac. /Dark Grey
Difusor: Opalino/Opal
Emb./Box Qt. 1pcs
P.U. 114,00€

Zeza 1100 SQ

Balizador Quadrado 1070mm em Resina, Difusor PMMA
Square Bollard 1070mm Resin Material, Diffuser PMMA



003.030WO.E27

E27 - Max. 20W
Base: 220mm
Diam.142mm/Alt.1070mm
Cor: Branco / White
Difusor: Opalino/Opal
Emb./Box Qt. 1pcs
P.U. 110,00€



003.030GO.E27

E27 - Max. 20W
Base: 220mm
Diam.142mm/Alt.1070mm
Cor: Cinza/Grey
Difusor: Opalino/Opal
Emb./Box Qt. 1pcs
P.U. 110,00€



003.030BO.E27

E27 - Max. 20W
Base: 220mm
Diam.142mm/Alt.1070mm
Cor: Preto/Black
Difusor: Opalino/Opal
Emb./Box Qt. 1pcs
P.U. 110,00€



003.030AO.E27

E27 - Max. 20W
Base: 220mm
Diam.142mm/Alt.1070mm
Cor: Antrac. /Dark Grey
Difusor: Opalino/Opal
Emb./Box Qt. 1pcs
P.U. 113,00€



003.030WO.4GU10

LED-4xGU10-Max.12W
Base: 220mm
Diam.142mm/Alt.1070mm
Cor: Branco / White
Difusor: Opalino/Opal
Emb./Box Qt. 1pcs
P.U. 125,00€



003.030GO.4GU10

LED-4xGU10-Max.12W
Base: 220mm
Diam.142mm/Alt.1070mm
Cor: Cinza/Grey
Difusor: Opalino/Opal
Emb./Box Qt. 1pcs
P.U. 125,00€



003.030BO.4GU10

LED-4xGU10-Max.12W
Base: 220mm
Diam.142mm/Alt.1070mm
Cor: Preto/Black
Difusor: Opalino/Opal
Emb./Box Qt. 1pcs
P.U. 125,00€



003.030AO.4GU10

LED-4xGU10-Max.12W
Base: 220mm
Diam.142mm/Alt.1070mm
Cor: Antrac. /Dark Grey
Difusor: Opalino/Opal
Emb./Box Qt. 1pcs
P.U. 128,00€

México

soflight®



Led: **OSRAM**

Driver: **MW** ou / or **TRIDONIC**

Placa Led 50 000 Horas; 5 Anos Garantia

Led PCB 50 000 Hours; 5 Years Warranty

Campânula Led em Resina LED High Bay Resin Material

MÉXICO



Campânula Led em Resina
LED High Bay Resin Material

Led: **OSRAM**

Driver: **MW** ou / or **TRIDONIC**

Placa Led 50 000 Horas; 5 Anos Garantia

Led PCB 50 000 Hours; 5 Years Warranty

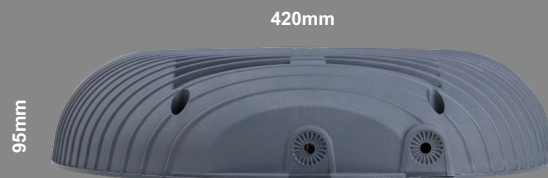

México-HB

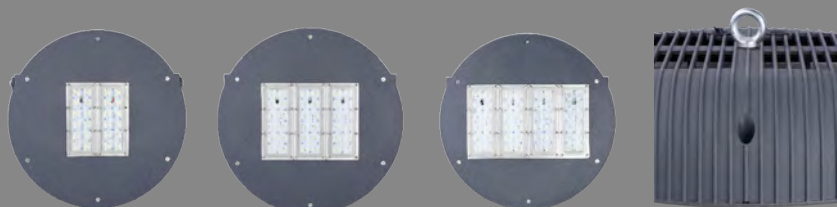

Campânula Led em Resina 120° / Led High Bay Resin Material

006.010.AC.050.54 Campanula / High Bay Led 40W 5 200lm 5700K em Resina / Resin Body	P.U. 147,00€
006.010.AC.050.84 Campanula / High Bay Led 40W 5 000lm 4000K em Resina / Resin Body	P.U. 147,00€
006.010.AC.100.54 Campanula / High Bay Led 80W 10 400lm 5700K em Resina / Resin Body	P.U. 182,00€
006.010.AC.100.84 Campanula / High Bay Led 80W 10 000lm 4000K em Resina / Resin Body	P.U. 182,00€
006.010.AC.150.54 Campanula / High Bay Led 120W 15 600lm 5700K em Resina / Resin Body	P.U. 216,00€
006.010.AC.150.84 Campanula / High Bay Led 120W 15 000lm 4000K em Resina / Resin Body	P.U. 216,00€
006.010.AC.200.54 Campanula / High Bay Led 160W 20 800lm 5700K em Resina / Resin Body	P.U. 287,00€
006.010.AC.200.84 Campanula / High Bay Led 160W 20 000lm 4000K em Resina / Resin Body	P.U. 287,00€

Campânula Led em Resina 90° / Led High Bay Resin Material

006.015.AC.050.54 Campanula / High Bay Led 40W 5 200lm 5700K em Resina / Resin Body	P.U. 147,00€
006.015.AC.050.84 Campanula / High Bay Led 40W 5 000lm 4000K em Resina / Resin Body	P.U. 147,00€
006.015.AC.100.54 Campanula / High Bay Led 80W 10 400lm 5700K em Resina / Resin Body	P.U. 182,00€
006.015.AC.100.84 Campanula / High Bay Led 80W 10 000lm 4000K em Resina / Resin Body	P.U. 182,00€
006.015.AC.150.54 Campanula / High Bay Led 120W 15 600lm 5700K em Resina / Resin Body	P.U. 216,00€
006.015.AC.150.84 Campanula / High Bay Led 120W 15 000lm 4000K em Resina / Resin Body	P.U. 216,00€
006.015.AC.200.54 Campanula / High Bay Led 160W 20 800lm 5700K em Resina / Resin Body	P.U. 287,00€
006.015.AC.200.84 Campanula / High Bay Led 160W 20 000lm 4000K em Resina / Resin Body	P.U. 287,00€

Campânula Led em Resina 60° / Led High Bay Resin Material

006.020.AC.050.54 Campanula / High Bay Led 40W 5 200lm 5700K em Resina / Resin Body	P.U. 147,00€
006.020.AC.050.84 Campanula / High Bay Led 40W 5 000lm 4000K em Resina / Resin Body	P.U. 147,00€
006.020.AC.100.54 Campanula / High Bay Led 80W 10 400lm 5700K em Resina / Resin Body	P.U. 182,00€
006.020.AC.100.84 Campanula / High Bay Led 80W 10 000lm 4000K em Resina / Resin Body	P.U. 182,00€
006.020.AC.150.54 Campanula / High Bay Led 120W 15 600lm 5700K em Resina / Resin Body	P.U. 216,00€
006.020.AC.150.84 Campanula / High Bay Led 120W 15 000lm 4000K em Resina / Resin Body	P.U. 216,00€
006.020.AC.200.54 Campanula / High Bay Led 160W 20 800lm 5700K em Resina / Resin Body	P.U. 287,00€
006.020.AC.200.84 Campanula / High Bay Led 160W 20 000lm 4000K em Resina / Resin Body	P.U. 287,00€

AC Input Voltage Range:	180-295Vac
Current Adjustment Range:	50% ~100%
Over Voltage Protection:	105% ~145%
Over Current Protection	95% ~108% Constant Current Limiting, Auto-Recovery
Over Temperature Protection:	Shut Down O/P Voltage, re-power on to recover
Working Temperature:	-20 ~ + 45°
Protections:	Short Circuit / Over Voltage / Over Temperature / IP65
ECO Design:	No Load Power Consumption < 0,5W
High Efficiency:	98%

Opções por Encomenda / Options:

- * DALI
- * Dimming: 0-10Vdc, PWM signal, or Resistance
- * Smart Timming Dimming Function
- * Lux Control

Devido à constante evolução deste tipo de produtos a marca dos Leds e Drivers assim como as características técnicas podem ser alterados sem aviso prévio, por favor consultar o folheto ou solicite a ficha técnica atualizada dos artigos pretendidos

Obs: Não Ligar com Sensores
Working Temperature -20 + 45°
Temperatura Funcionamento -20 + 45°



Projeto Led em Resina
LED Floodlight Resin Material

Led: **OSRAM**

Driver: **MW** ou / or **TRIDONIC**

Placa Led 50 000 Horas; 5 Anos Garantia

Led PCB 50 000 Hours; 5 Years Warranty

México - FL

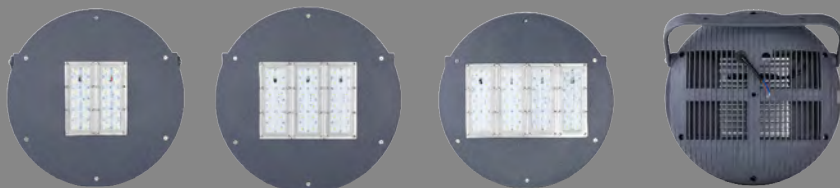
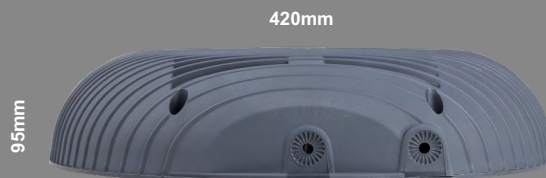

Projeto Led em Resina 120° / Floodlight Resin Material

006.045.AC.050.54 Projector / Floodlight Led 40W 5 200lm 5700K em Resina / Resin Body	P.U. 151,00€
006.045.AC.050.84 Projector / Floodlight Led 40W 5 000lm 4000K em Resina / Resin Body	P.U. 151,00€
006.045.AC.100.54 Projector / Floodlight Led 80W 10 400lm 5700K em Resina / Resin Body	P.U. 187,00€
006.045.AC.100.84 Projector / Floodlight Led 80W 10 000lm 4000K em Resina / Resin Body	P.U. 187,00€
006.045.AC.150.54 Projector / Floodlight Led 120W 15 600lm 5700K em Resina / Resin Body	P.U. 220,00€
006.045.AC.150.84 Projector / Floodlight Led 120W 15 000lm 4000K em Resina / Resin Body	P.U. 220,00€
006.045.AC.200.54 Projector / Floodlight Led 160W 20 800lm 5700K em Resina / Resin Body	P.U. 291,00€
006.045.AC.200.84 Projector / Floodlight Led 160W 20 000lm 4000K em Resina / Resin Body	P.U. 291,00€

Projeto Led em Resina 90° / Floodlight Resin Material

006.050.AC.050.54 Projector / Floodlight Led 40W 5 200lm 5700K em Resina / Resin Body	P.U. 151,00€
006.050.AC.050.84 Projector / Floodlight Led 40W 5 000lm 4000K em Resina / Resin Body	P.U. 151,00€
006.050.AC.100.54 Projector / Floodlight Led 80W 10 400lm 5700K em Resina / Resin Body	P.U. 187,00€
006.050.AC.100.84 Projector / Floodlight Led 80W 10 000lm 4000K em Resina / Resin Body	P.U. 187,00€
006.050.AC.150.54 Projector / Floodlight Led 120W 15 600lm 5700K em Resina / Resin Body	P.U. 220,00€
006.050.AC.150.84 Projector / Floodlight Led 120W 15 000lm 4000K em Resina / Resin Body	P.U. 220,00€
006.050.AC.200.54 Projector / Floodlight Led 160W 20 800lm 5700K em Resina / Resin Body	P.U. 291,00€
006.050.AC.200.84 Projector / Floodlight Led 160W 20 000lm 4000K em Resina / Resin Body	P.U. 291,00€

Projeto Led em Resina 60° / Floodlight Resin Material

006.055.AC.050.54 Projector / Floodlight Led 40W 5 200lm 5700K em Resina / Resin Body	P.U. 151,00€
006.055.AC.050.84 Projector / Floodlight Led 40W 5 000lm 4000K em Resina / Resin Body	P.U. 151,00€
006.055.AC.100.54 Projector / Floodlight Led 80W 10 400lm 5700K em Resina / Resin Body	P.U. 187,00€
006.055.AC.100.84 Projector / Floodlight Led 80W 10 000lm 4000K em Resina / Resin Body	P.U. 187,00€
006.055.AC.150.54 Projector / Floodlight Led 120W 15 600lm 5700K em Resina / Resin Body	P.U. 220,00€
006.055.AC.150.84 Projector / Floodlight Led 120W 15 000lm 4000K em Resina / Resin Body	P.U. 220,00€
006.055.AC.200.54 Projector / Floodlight Led 160W 20 800lm 5700K em Resina / Resin Body	P.U. 291,00€
006.055.AC.200.84 Projector / Floodlight Led 160W 20 000lm 4000K em Resina / Resin Body	P.U. 291,00€

Projeto Led Resina Assimetrico / Floodlight Resin Material

006.060.AC.050.54 Projector / Floodlight Led 40W 5 200lm 5700K em Resina / Resin Body	P.U. 151,00€
006.060.AC.050.84 Projector / Floodlight Led 40W 5 000lm 4000K em Resina / Resin Body	P.U. 151,00€
006.060.AC.100.54 Projector / Floodlight Led 80W 10 400lm 5700K em Resina / Resin Body	P.U. 187,00€
006.060.AC.100.84 Projector / Floodlight Led 80W 10 000lm 4000K em Resina / Resin Body	P.U. 187,00€
006.060.AC.150.54 Projector / Floodlight Led 120W 15 600lm 5700K em Resina / Resin Body	P.U. 220,00€
006.060.AC.150.84 Projector / Floodlight Led 120W 15 000lm 4000K em Resina / Resin Body	P.U. 220,00€
006.060.AC.200.54 Projector / Floodlight Led 160W 20 800lm 5700K em Resina / Resin Body	P.U. 291,00€
006.060.AC.200.84 Projector / Floodlight Led 160W 20 000lm 4000K em Resina / Resin Body	P.U. 291,00€

AC Input Voltage Range:	180-295Vac
Current Adjustment Range:	50% ~100%
Over Voltage Protection:	105% ~145%
Over Current Protection	95% ~108% Constant Current Limiting, Auto-Recovery
Over Temperature Protection:	Shut Down O/P Voltage, re-power on to recover
Working Temperature:	-20 ~ + 45°
Protections:	Short Circuit / Over Voltage / Over Temperature / IP65
ECO Design:	No Load Power Consumption < 0,5W
High Efficiency:	98%

- Opções por Encomenda / Options:**
- * DALI
 - * Dimming: 0-10Vdc, PWM signal, or Resistance
 - * Smart Timing Dimming Function
 - * Lux Control

Devido à constante evolução deste tipo de produtos a marca dos Leds e Drivers assim como as características técnicas podem ser alterados sem aviso prévio, por favor consultar o folheto ou solicite a ficha técnica atualizada dos artigos pretendidos

Obs: Não Ligar com Sensores
Working Temperature -20 + 45°
Temperatura Funcionamento -20 + 45°

Armadura Estanque Led com Difusor Opalino em PC
Waterproof Lighting Opal Diffuser PC

Led: OSRAM

Placa Led 50 000 Horas; 5 Anos Garantia
 Led PCB 50 000 Hours; 5 Years Warranty



Lisboa

Armadura Estanque Led IP 65 (Barra com 1 linha Led)
Waterproof Lighting Led IP 65 (Pcb with 1 Led Line)

- 008.010.GO.010.54 Arm. Est. Led 0,60mt / Led Waterp.6000K 12W 1620lm
- 008.010.GO.010.84 Arm. Est. Led 0,60mt / Led Waterp.4000K 12W 1440m
- 008.010.GO.020.54 Arm. Est. Led 1,20mt / Led Waterp.6000K 25W 3240lm
- 008.010.GO.020.84 Arm. Est. Led 1,20mt / Led Waterp.4000K 25W 2880lm
- 008.010.GO.030.54 Arm. Est. Led 1,50mt / Led Waterp.6000K 30W 4050lm
- 008.010.GO.030.84 Arm. Est. Led 1,50mt / Led Waterp.4000K 30W 3600lm

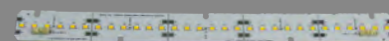

Electrificado com barra Led (**Osram**) Dupla (2 Linhas)
 Assembled with **Osram** Led (2 Led Line)

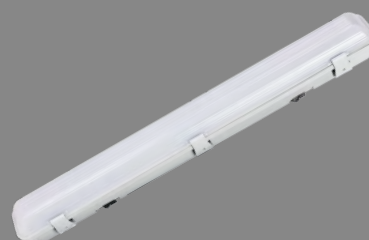

- P.U. 56,00€
- P.U. 56,00€
- P.U. 89,00€
- P.U. 89,00€
- P.U. 133,50€
- P.U. 133,50€

Armadura Estanque Led IP 65 (Barra com 2 linhas Led)
Waterproof Lighting Led IP 65 (Pcb with 2 Led Lines)

- 008.020.GO.010.54 Arm.Est.Led 0,60mt / Led Waterp.6000K 24W 3240lm
- 008.020.GO.010.84 Arm. Est. Led 0,60mt / Led Waterp.4000K 24W 2880lm
- 008.020.GO.020.54 Arm. Est. Led 1,20mt / Led Waterp. 6000K 50W 6480lm
- 008.020.GO.020.84 Arm. Est. Led 1,20mt / Led Waterp. 4000K 50W 5760lm
- 008.020.GO.030.54 Arm. Est. Led 1,50mt / Led Waterp. 6000K 60W 8100lm
- 008.020.GO.030.84 Arm. Est. Led 1,50mt / Led Waterp. 4000K 60W 7200lm



Electrificado com barra Led (**Osram**) Simples (Linha)
 Assembled with **Osram** Led (1 Led Line)



- P.U. 75,00€
- P.U. 75,00€
- P.U. 150,00€
- P.U. 150,00€
- P.U. 190,00€
- P.U. 190,00€

Rafa

Campanula Industrial em Resina
Resin High Bay

Rafa



005.010.B0.E27

E27 Vazia - Max. 400W
 Antracite/Dark Grey
 Emb./Box Qt. 2pcs
 P.U. 35,00€



005.010.B0.E40

E40 Vazia - Max. 400W
 Antracite/Dark Grey
 Emb./Box Qt. 2pcs
 P.U. 35,00€



005.040.A0.000

Reflector Alumínio Liso
 Aluminium Reflector
 Diam.: 480mm
 P.U. 22,00€



005.050.A0.000

Reflector Alum. Canelado
 Aluminium Reflector
 Diam.: 480mm
 P.U. 22,00€



005.060.CC.000

Vidro Temperado
 Clear Tempered Glass
 Diam.: 480mm
 P.U. 15,50€





230.400.000.GG

Caixa Pladur Quadrupla
Mounting Aid,Cavity Wall systems
IP 20
Cinza / Grey: Ral 7035
Comprimento 400mm
Largura: 93mm
Altura: 62mm
Emb./Box Qt.: 50 pcs
P.U. 8,00€

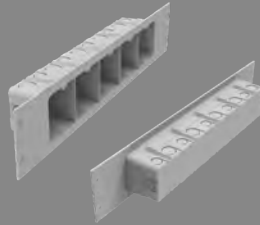

230.500.000.GG

Caixa Pladur Quintupla
Mounting Aid,Cavity Wall systems
IP 20
Cinza / Grey: Ral 7035
Comprimento 500mm
Largura: 93mm
Altura: 62mm
Emb./Box Qt.: 50 pcs
P.U. 8,50€

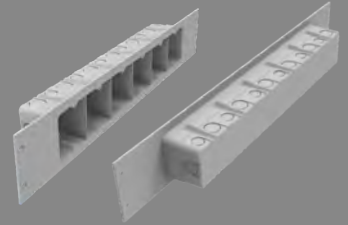

230.600.000.GG

Caixa Pladur Sextupla
Mounting Aid,Cavity Wall systems
IP 20
Cinza / Grey: Ral 7035
Comprimento 600mm
Largura: 93mm
Altura: 62mm
Emb./Box Qt.: 50 pcs
P.U. 9,00€



220.045.040.000.GG

Caixa Aplique
M.Aid,Cavity Wall systems
IP 20
Cinza / Grey: Ral 7035
Diam.: 45mm
Altura: 40mm
Emb./Box Qt.: 50 pcs
P.U. 0,99€



220.070.040.000.GG

Caixa Aparelhagem Baixa
M. Aid,Cavity Wall systems
IP 20
Cinza / Grey: Ral 7035
Diam.: 70mm
Altura: 40mm
Emb./Box Qt.: 100 pcs
P.U. 1,05€



220.070.060.000.GG

Caixa Aparelhagem Funda
M.Aid,Cavity Wall systems
IP 20
Cinza / Grey: Ral 7035
Diam.: 70mm
Altura: 60mm
Emb./Box Qt. 50 pcs
P.U. 1,10€



220.070.040.002.GG

Caixa Aparelhagem Dupla
M.Aid,Cavity Wall systems
IP 20
Cinza / Grey: Ral 7035
Diam.: 70mm
Altura: 50mm
Emb./Box Qt.: 28 pcs
P.U. 2,20€



220.070.040.003.GG

Caixa Aparelhagem Tripla
M.Aid,Cavity Wall systems
IP 20
Cinza / Grey: Ral 7035
Diam.: 70mm
Altura: 50mm
Emb./Box Qt. 16 pcs
P.U. 3,30€



220.115.045.000.GG

Caixa Quadrada c/Tampa
M.Aid,Cavity Wall systems
IP 20
Cinza / Grey: Ral 7035
Diam.: 115x115mm
Altura: 45mm
Emb./Box Qt.: 36 pcs
P.U. 3,50€



220.045.TMP.WH

Tampa p/ Caixa Aplique
M.Aid,Cavity Wall systems
IP 20
Cor: Branca / White
Diam.: 55mm

P.U. 0.15€



220.070.001.TMP.WH

Tampa p/ Caixa Aparelhagem
M.Aid,Cavity Wall systems
IP 20
Cor: Branca / White
Diam.: 82mm

P.U. 0.21€

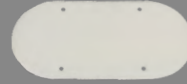

220.070.002.TMP.WH

T. dupla p/ Caixa Aparelhagem
M. Aid,Cavity Wall systems
IP 20
Cor: Branca / White
Altura: 78mm
Comprimento: 160mm

P.U. 0.55€

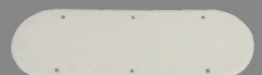

220.070.003.TMP.WH

T. Tripla p/ Caixa Aparelhagem
M. Aid,Cavity Wall systems
IP 20
Cor: Branca / White
Altura: 78mm
Comprimento: 235mm

P.U. 0.85€



225.041.035.000.PP

Caixa Aplique
IP 20
Cor: Branca / White
Dimensões: 41x35mm
Embalagem: 50Unid.
P.U. 0.13€



225.070.040.000.PP

Caixa Aparelhagem Baixa
Mounting Aid,Cavity Wall systems
IP 20
Cor: Branca / White
Dimensões: 70x40mm
Embalagem: 10Unid.
P.U. 0.19€



225.070.060.000.PP

Caixa Aparelhagem Funda
Mounting Aid,Cavity Wall systems
IP 20
Cor: Branca / White
Dimensões: 70x60mm
Embalagem: 10Unid.
P.U. 0.25€



225.090.090.040.PP

Caixa Derivação Quadrada com Tampa
Mounting Aid,Cavity Wall systems
IP 20
Cor: Branca / White
Dimensões: 90x90x40mm
Embalagem: 10Unid.
P.U. 0.50€

Caixa Derivação IP 65 / IP 66- Ensaio Fio Incandescente 650°
Junction Box IP 65/ IP 66 - Glow Wire 650°



Caixas B...

Quantidade Mínima 96 Unid.



200.080.044.035.GG

Modelo: B044
Caixa Derivação IP 65
Junction Box IP 65
Cinza / Grey: Ral 7035
80x44x35mm
Emb./Box Qt. 96pcs
P.U. 0,92€



200.200.150.080.GG

Modelo B200
Caixa Derivação IP 66
Junction Box IP 66
Cinza / Grey: Ral 7035
200x150x80mm
Emb./Box Qt. 12pcs
P.U. 5,90€



200.250.200.140.GT

Modelo B250
Caixa Derivação IP 66
Junction Box IP 66
Cinza / Grey: Ral 7035
250x200x140mm
Emb./Box Qt. 1pcs
P.U. 17,00€

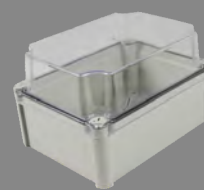

201.200.150.125.GT

Modelo B250
Caixa Derivação IP 66
Junction Box IP 66
Cinza / Grey: Ral 7035
200x150x125mm
Emb./Box Qt. 1pcs
P.U. 10,50€



200.200.150.125.GM

Caixa Guarda Motor
Caixa Derivação IP 66
Junction Box IP 66
Cinza / Grey: Ral 7035
200x150x125mm
Emb./Box Qt. 1pcs
P.U. 17,00€

Quantidade Mínima 168 Unid.

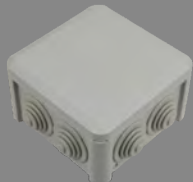

200.090.090.053.GG

Modelo: B090
Caixa Derivação IP 65
Junction Box IP 65
Cinza / Grey: Ral 7035
90x90x53mm
Emb./Box Qt. 168pcs
P.U. 1,50€



200.200.150.125.GG

Modelo B200
Caixa Derivação IP 66
Junction Box IP 66
Cinza / Grey: Ral 7035
200x150x125mm
Emb./Box Qt. 12pcs
P.U. 7,60€

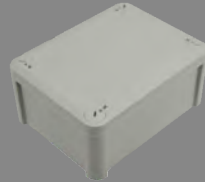

201.150.115.070.GG

Modelo B150
Caixa Derivação IP 66
Junction Box IP 66
Cinza / Grey: Ral 7035
150x115x70mm
Emb./Box Qt. 12pcs
P.U. 4,00€



201.250.200.140.GG

Modelo B250
Caixa Derivação IP 66
Junction Box IP 66
Cinza / Grey: Ral 7035
250x200x140mm
Emb./Box Qt. 1pcs
P.U. 9,70€



200.250.200.140.QS

Caixa para Quadro Sondas
Caixa Derivação IP 66
Junction Box IP 66
Antracite / Dark
250x200x140mm
Emb./Box Qt. 1pcs
P.U. 18,00€

Quantidade Mínima 36 Unid.



200.115.115.060.GG

Modelo: B115
Caixa Derivação IP 66
Junction Box IP 66
Cinza / Grey: Ral 7035
115x115x60mm
Emb./Box Qt. 36pcs
P.U. 2,20€



200.200.150.125.GT

Modelo B200
Caixa Derivação IP 66
Junction Box IP 66
Cinza / Grey: Ral 7035
200x150x125mm
Emb./Box Qt. 1pcs
P.U. 11,00€

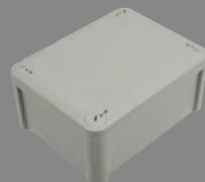

201.200.150.080.GG

Modelo B200
Caixa Derivação IP 66
Junction Box IP 66
Cinza / Grey: Ral 7035
200x150x80mm
Emb./Box Qt. 1pcs
P.U. 5,80€

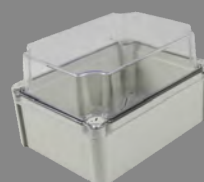

201.250.200.140.GT

Modelo B250
Caixa Derivação IP 66
Junction Box IP 66
Cinza / Grey: Ral 7035
250x200x140mm
Emb./Box Qt. 1pcs
P.U. 16,00€

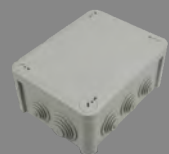

200.150.115.070.GG

Modelo B150
Caixa Derivação IP 66
Junction Box IP 66
Cinza / Grey: Ral 7035
150x115x70mm
Emb./Box Qt. 12pcs
P.U. 4,10€



200.250.200.140.GG

Modelo B250
Caixa Derivação IP 66
Junction Box IP 66
Cinza / Grey: Ral 7035
250x200x140mm
Emb./Box Qt. 1pcs
P.U. 10,50€



201.200.150.125.GG

Modelo B200
Caixa Derivação IP 66
Junction Box IP 66
Cinza / Grey: Ral 7035
200x150x125mm
Emb./Box Qt. 1pcs
P.U. 7,00€

Lineares em Led



Lumiar 46

soflight®



Luminária em Alumínio Extrudido c/ Barra Led e Driver
Extruded Aluminium Equipped with Led PCB and Driver



Led: **OSRAM**

Driver: **AMW** ou / or **TRIDONIC**

Placa Led 50 000 Horas; 5 Anos Garantia

Led PCB 50 000 Hours; 5 Years Warranty

Electrificado com barra Led (Osram) Simples (1 Linha)
Assembled with Osram Led (1 Led Line)

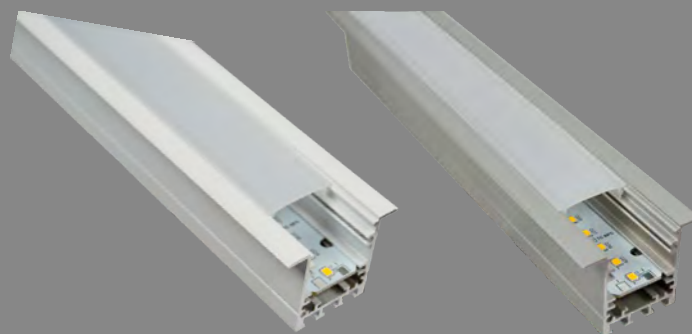
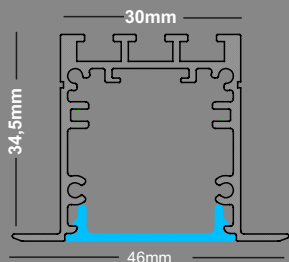

Lumiar 46

Código/Code	Led / Lm / W	L	Cor/Color	€	Código/Code	Led / Lm / W	L	Cor/Color	€
010.0580WO.001.82	2700K / 1220Lm / 15W	580mm	BR/White	P.U. 110,00	010.1700WO.001.82	2700K / 3700Lm / 35W	1700mm	BR/White	P.U. 185,00
010.0580ACO.001.82	2700K / 1220Lm / 15W	580mm	Acet. Nat./ Nat.Satin	P.U. 110,00	010.1700ACO.001.82	2700K / 3700Lm / 35W	1700mm	Acet. Nat./Anodized	P.U. 185,00
					010.1700ANO.001.82				
010.0580WO.001.84	4000K / 1300Lm / 15W	580mm	BR/White	P.U. 110,00	010.1700WO.001.84	4000K / 3800Lm / 35W	1700mm	BR/White	P.U. 185,00
010.0580ACO.001.84	4000K / 1300Lm / 15W	580mm	Acet. Nat./ Nat.Satin	P.U. 110,00	010.1700ACO.001.84	4000K / 3800Lm / 35W	1700mm	Acet. Nat./Anodized	P.U. 185,00
					010.1700ANO.001.84				
010.0580WO.001.54	5700K / 1350Lm / 15W	580mm	BR/White	P.U. 110,00	010.1700WO.001.54	5700K / 3900Lm / 35W	1700mm	BR/White	P.U. 185,00
010.0580ACO.001.54	5700K / 1350Lm / 15W	580mm	Acet. Nat./ Nat.Satin	P.U. 110,00	010.1700ACO.001.54	5700K / 3900Lm / 35W	1700mm	Acet. Nat./Anodized	P.U. 185,00
					010.1700ANO.001.54				
010.0860WO.001.82	2700K / 1850Lm / 20W	860mm	BR/White	P.U. 125,00	010.1980WO.001.82	2700K / 4300Lm / 40W	1980mm	BR/White	P.U. 200,00
010.0860ACO.001.82	2700K / 1850Lm / 20W	860mm	Acet. Nat./ Nat.Satin	P.U. 125,00	010.1980ACO.001.82	2700K / 4300Lm / 40W	1980mm	Acet. Nat./Anodized	P.U. 200,00
					010.1980ANO.001.82				
010.0860WO.001.84	4000K / 1900Lm / 20W	860mm	BR/White	P.U. 125,00	010.1980WO.001.84	4000K / 4450Lm / 40W	1980mm	BR/White	P.U. 200,00
010.0860ACO.001.84	4000K / 1900Lm / 20W	860mm	Acet. Nat./ Nat.Satin	P.U. 125,00	010.1980ACO.001.84	4000K / 4450Lm / 40W	1980mm	Acet. Nat./Anodized	P.U. 200,00
					010.1980ANO.001.84				
010.0860WO.001.54	5700K / 1950Lm / 20W	860mm	BR/White	P.U. 125,00	010.1980WO.001.54	5700K / 4550Lm / 40W	1980mm	BR/White	P.U. 200,00
010.0860ACO.001.54	5700K / 1950Lm / 20W	860mm	Acet. Nat./ Nat.Satin	P.U. 125,00	010.1980ACO.001.54	5700K / 4550Lm / 40W	1980mm	Acet. Nat./Anodized	P.U. 200,00
					010.1980ANO.001.54				
010.1140WO.001.82	2700K / 2450Lm / 25W	1140mm	BR/White	P.U. 152,00	010.2260WO.001.82	2700K / 4900Lm / 45W	2260mm	BR/White	P.U. 218,00
010.1140ACO.001.82	2700K / 2450Lm / 25W	1140mm	Acet. Nat./ Nat. Satin	P.U. 152,00	010.2260ACO.001.82	2700K / 4900Lm / 45W	2260mm	Acet. Nat./Anodized	P.U. 218,00
					010.2260ANO.001.82				
010.1140WO.001.84	4000K / 2550Lm / 25W	1140mm	BR/White	P.U. 152,00	010.2260WO.001.84	4000K / 5050Lm / 45W	2260mm	BR/White	P.U. 218,00
010.1140ACO.001.84	4000K / 2550Lm / 25W	1140mm	Acet. Nat./ Nat.Satin	P.U. 152,00	010.2260ACO.001.84	4000K / 5050Lm / 45W	2260mm	Acet. Nat./Anodized	P.U. 218,00
					010.2260ANO.001.84				
010.1140WO.001.54	5700K / 2650Lm / 25W	1140mm	BR/White	P.U. 152,00	010.2260WO.001.54	5700K / 5200Lm / 45W	2260mm	BR/White	P.U. 218,00
010.1140ACO.001.54	5700K / 2650Lm / 25W	1140mm	Acet. Nat./ Nat. Satin	P.U. 152,00	010.2260ACO.001.54	5700K / 5200Lm / 45W	2260mm	Acet. Nat./Anodized	P.U. 218,00
					010.2260ANO.001.54				
010.1420WO.001.82	2700K / 3050Lm / 30W	1420mm	BR/White	P.U. 167,00	010.2540WO.001.82	2700K / 5500Lm / 50W	2540mm	BR/White	P.U. 231,00
010.1420ACO.001.82	2700K / 3050Lm / 30W	1420mm	Acet. Nat./ Nat. Satin	P.U. 167,00	010.2540ACO.001.82	2700K / 5500Lm / 50W	2540mm	Acet. Nat./Anodized	P.U. 231,00
					010.2540ANO.001.82				
010.1420WO.001.84	4000K / 3150Lm / 30W	1420mm	BR/White	P.U. 167,00	010.2540WO.001.84	4000K / 5700Lm / 50W	2540mm	BR/White	P.U. 231,00
010.1420ACO.001.84	4000K / 3150Lm / 30W	1420mm	Acet. Nat./ Nat. Satin	P.U. 167,00	010.2540ACO.001.84	4000K / 5700Lm / 50W	2540mm	Acet. Nat./Anodized	P.U. 231,00
					010.2540ANO.001.84				
010.1420WO.001.54	5700K / 3250Lm / 30W	1420mm	BR/White	P.U. 167,00	010.2540WO.001.54	5700K / 5900Lm / 50W	2540mm	BR/White	P.U. 231,00
010.1420ACO.001.54	5700K / 3250Lm / 30W	1420mm	Acet. Nat./Anodized	P.U. 167,00	010.2540ACO.001.54	5700K / 5900Lm / 50W	2540mm	Acet. Nat./Anodized	P.U. 231,00
					010.2540ANO.001.54				
					010.2820WO.001.82	2700K / 6100Lm / 55W	2820mm	BR/White	P.U. 254,00
					010.2820ACO.001.82	2700K / 6100Lm / 55W	2820mm	Acet. Nat./Anodized	P.U. 254,00
					010.2820ANO.001.82				
					010.2820WO.001.84	4000K / 6300Lm / 55W	2820mm	BR/White	P.U. 254,00
					010.2820ACO.001.84	4000K / 6300Lm / 55W	2820mm	Acet. Nat./Anodized	P.U. 254,00
					010.2820ANO.001.84				
					010.2820WO.001.54	5700K / 6500Lm / 55W	2820mm	BR/White	P.U. 254,00
					010.2820ACO.001.54	5700K / 6500Lm / 55W	2820mm	Acet. Nat./Anodized	P.U. 254,00
					010.2820ANO.001.54				

Opções por Encomenda: Dimensões Específicas (mínimo 56mm) - Kit de Emergência - DALI - Dimável - Sistema de controle de Iluminação (lux contol)

Obs: Não ligar com Sensores

Devido à constante evolução deste tipo de produtos a marca dos Leds e Drivers assim como as características técnicas podem ser alterados sem aviso prévio, por favor consultar o folheto ou solicitar a ficha técnica atualizada dos artigos pretendidos.



Luminária em Alumínio Extrudido c/ Barra Led e Driver
Extruded Aluminium Equipped with Led PCB and Driver



Led: **OSRAM**

Driver: **AMW** ou / or **TRIDONIC**

Placa Led 50 000 Horas; 5 Anos Garantia

Led PCB 50 000 Hours; 5 Years Warranty

Electrificado com barra Led (Osram) Simples (1 Linha)
Assembled with Osram Led (1 Led Line)

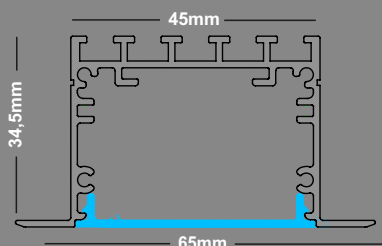

Lumiar 65

Código/Code	Led / Lm / W	L	Cor/Color	€	Código/Code	Led / Lm / W	L	Cor/Color	€
011.0580WO.001.82	2700K / 1220Lm / 15W	580mm	BR/White	P.U. 116,00	011.1980WO.001.82	2700K / 4300Lm / 40W	1980mm	BR/White	P.U. 210,00
011.0580ACO.001.82	2700K / 1220Lm / 15W	580mm	Acet. Nat./ Nat.Satin	P.U. 116,00	011.1980ACO.001.82	2700K / 4300Lm / 40W	1980mm	Acet. Nat./Anodized	P.U. 210,00
011.0580WO.001.84	4000K / 1300Lm / 15W	580mm	BR/White	P.U. 116,00	011.1980WO.001.84	4000K / 4450Lm / 40W	1980mm	BR/White	P.U. 210,00
011.0580ACO.001.84	4000K / 1300Lm / 15W	580mm	Acet. Nat./ Nat.Satin	P.U. 116,00	011.1980ACO.001.84	4000K / 4450Lm / 40W	1980mm	Acet. Nat./Anodized	P.U. 210,00
011.0580WO.001.54	5700K / 1350Lm / 15W	580mm	BR/White	P.U. 116,00	011.1980WO.001.54	5700K / 4550Lm / 40W	1980mm	BR/White	P.U. 210,00
011.0580ACO.001.54	5700K / 1350Lm / 15W	580mm	Acet. Nat./ Nat.Satin	P.U. 116,00	011.1980ACO.001.54	5700K / 4550Lm / 40W	1980mm	Acet. Nat./Anodized	P.U. 210,00
011.0860WO.001.82	2700K / 1850Lm / 20W	860mm	BR/White	P.U. 131,00	011.2260WO.001.82	2700K / 4900Lm / 45W	2260mm	BR/White	P.U. 231,00
011.0860ACO.001.82	2700K / 1850Lm / 20W	860mm	Acet. Nat./ Nat.Satin	P.U. 131,00	011.2260ACO.001.82	2700K / 4900Lm / 45W	2260mm	Acet. Nat./Anodized	P.U. 231,00
011.0860WO.001.84	4000K / 1900Lm / 20W	860mm	BR/White	P.U. 131,00	011.2260WO.001.84	4000K / 5050Lm / 45W	2260mm	BR/White	P.U. 231,00
011.0860ACO.001.84	4000K / 1900Lm / 20W	860mm	Acet. Nat./ Nat.Satin	P.U. 131,00	011.2260ACO.001.84	4000K / 5050Lm / 45W	2260mm	Acet. Nat./Anodized	P.U. 231,00
011.0860WO.001.54	5700K / 1950Lm / 20W	860mm	BR/White	P.U. 131,00	011.2260WO.001.54	5700K / 5200Lm / 45W	2260mm	BR/White	P.U. 231,00
011.0860ACO.001.54	5700K / 1950Lm / 20W	860mm	Acet. Nat./ Nat.Satin	P.U. 131,00	011.2260ACO.001.54	5700K / 5200Lm / 45W	2260mm	Acet. Nat./Anodized	P.U. 231,00
011.1140WO.001.82	2700K / 2450Lm / 25W	1140mm	BR/White	P.U. 158,00	011.2540WO.001.82	2700K / 5500Lm / 50W	2540mm	BR/White	P.U. 243,00
011.1140ACO.001.82	2700K / 2450Lm / 25W	1140mm	Acet. Nat./ Nat. Satin	P.U. 158,00	011.2540ACO.001.82	2700K / 5500Lm / 50W	2540mm	Acet. Nat./Anodized	P.U. 243,00
011.1140WO.001.84	4000K / 2550Lm / 25W	1140mm	BR/White	P.U. 158,00	011.2540WO.001.84	4000K / 5700Lm / 50W	2540mm	BR/White	P.U. 243,00
011.1140ACO.001.84	4000K / 2550Lm / 25W	1140mm	Acet. Nat./ Nat.Satin	P.U. 158,00	011.2540ACO.001.84	4000K / 5700Lm / 50W	2540mm	Acet. Nat./Anodized	P.U. 243,00
011.1140WO.001.54	5700K / 2650Lm / 25W	1140mm	BR/White	P.U. 158,00	011.2540WO.001.54	5700K / 5900Lm / 50W	2540mm	BR/White	P.U. 243,00
011.1140ACO.001.54	5700K / 2650Lm / 25W	1140mm	Acet. Nat./ Nat. Satin	P.U. 158,00	011.2540ACO.001.54	5700K / 5900Lm / 50W	2540mm	Acet. Nat./Anodized	P.U. 243,00
011.1420WO.001.82	2700K / 3050Lm / 30W	1420mm	BR/White	P.U. 174,00	011.2820WO.001.82	2700K / 6100Lm / 55W	2820mm	BR/White	P.U. 267,00
011.1420ACO.001.82	2700K / 3050Lm / 30W	1420mm	Acet. Nat./ Nat. Satin	P.U. 174,00	011.2820ACO.001.82	2700K / 6100Lm / 55W	2820mm	Acet. Nat./Anodized	P.U. 267,00
011.1420WO.001.84	4000K / 3150Lm / 30W	1420mm	BR/White	P.U. 174,00	011.2820WO.001.84	4000K / 6300Lm / 55W	2820mm	BR/White	P.U. 267,00
011.1420ACO.001.84	4000K / 3150Lm / 30W	1420mm	Acet. Nat./ Nat. Satin	P.U. 174,00	011.2820ACO.001.84	4000K / 6300Lm / 55W	2820mm	Acet. Nat./Anodized	P.U. 267,00
011.1420WO.001.54	5700K / 3250Lm / 30W	1420mm	BR/White	P.U. 174,00	011.2820WO.001.54	5700K / 6500Lm / 55W	2820mm	BR/White	P.U. 267,00
011.1420ACO.001.54	5700K / 3250Lm / 30W	1420mm	Acet. Nat./Anodized	P.U. 174,00	011.2820ACO.001.54	5700K / 6500Lm / 55W	2820mm	Acet. Nat./Anodized	P.U. 267,00
011.1700WO.001.82	2700K / 3700Lm / 35W	1700mm	BR/White	P.U. 194,00					
011.1700ACO.001.82	2700K / 3700Lm / 35W	1700mm	Acet. Nat./ Nat. Satin	P.U. 194,00					
011.1700WO.001.84	4000K / 3800Lm / 35W	1700mm	BR/White	P.U. 194,00					
011.1700ACO.001.84	4000K / 3800Lm / 35W	1700mm	Acet. Nat./ Nat. Satin	P.U. 194,00					
011.1700WO.001.54	5700K / 3900Lm / 35W	1700mm	BR/White	P.U. 194,00					
011.1700ACO.001.54	5700K / 3900Lm / 35W	1700mm	Acet. Nat./Anodized	P.U. 194,00					

Opções por Encomenda: Dimensões Específicas (mínimo 56mm) - Kit de Emergência - DALI - Dimável - Sistema de controle de Iluminação (lux contol)

Obs: Não ligar com Sensores

Devido à constante evolução desta linha de produtos a marca dos Led's e Drivers assim como as características técnicas podem ser alterados sem aviso prévio, por favor consultar o folheto ou site da linha técnica atualizada dos artigos pretendidos

Lumiar 65

soflight®



Luminária em Alumínio Extrudido c/ Barra Led e Driver
Extruded Aluminium Equipped with Led PCB and Driver

Led: **OSRAM**

Driver: **MW** ou / or **TRIDONIC**

Placa Led 50 000 Horas; 5 Anos Garantia

Led PCB 50 000 Hours; 5 Years Warranty



Electrificado com barra Led (**Osram**) Dupla (2 Linhas)
Assembled with **Osram** Led (2 Led Line)

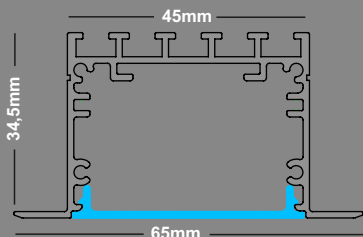

Lumiar 65

Código/Code	Led / Lm / W	L	Cor/Color	€	Código/Code	Led / Lm / W	L	Cor/Color	€
011.0580WO.002.82	2700K / 2450Lm / 25W	580mm	BR/White	P.U. 130,00	011.1980WO.002.82	2700K / 8550Lm / 75W	1980mm	BR/White	P.U. 306,00
011.0580ACO.002.82	2700K / 2450Lm / 25W	580mm	Acet. Nat./ Nat.Satin	P.U. 130,00	011.1980ACO.002.82	2700K / 8550Lm / 75W	1980mm	Acet. Nat./Anodized	P.U. 306,00
011.0580ANO.002.82	2700K / 2450Lm / 25W		Antr./Dark Grey						
011.0580WO.002.84	4000K / 2550Lm / 25W	580mm	BR/White	P.U. 130,00	011.1980WO.002.84	4000K / 8850Lm / 75W	1980mm	BR/White	P.U. 306,00
011.0580ACO.002.84	4000K / 2550Lm / 25W	580mm	Acet. Nat./ Nat.Satin	P.U. 130,00	011.1980ACO.002.84	4000K / 8850Lm / 75W	1980mm	Acet. Nat./Anodized	P.U. 306,00
011.0580WO.002.54	5700K / 2620Lm / 25W	580mm	BR/White	P.U. 130,00	011.1980WO.002.54	5700K / 9150Lm / 75W	1980mm	BR/White	P.U. 306,00
011.0580ACO.002.54	5700K / 2620Lm / 25W	580mm	Acet. Nat./ Nat.Satin	P.U. 130,00	011.1980ACO.002.54	5700K / 9150Lm / 75W	1980mm	Acet. Nat./Anodized	P.U. 306,00
011.0860WO.002.82	2700K / 3700Lm / 35W	860mm	BR/White	P.U. 147,00	011.2260WO.002.82	2700K / 9750Lm / 90W	2260mm	BR/White	P.U. 330,00
011.0860ACO.002.82	2700K / 3700Lm / 35W	860mm	Acet. Nat./ Nat.Satin	P.U. 147,00	011.2260ACO.002.82	2700K / 9750Lm / 90W	2260mm	Acet. Nat./Anodized	P.U. 330,00
011.0860WO.002.84	4000K / 3800Lm / 35W	860mm	BR/White	P.U. 147,00	011.2260WO.002.84	4000K / 10100Lm / 90W	2260mm	BR/White	P.U. 330,00
011.0860ACO.002.84	4000K / 3800Lm / 35W	860mm	Acet. Nat./ Nat.Satin	P.U. 147,00	011.2260ACO.002.84	4000K / 10100Lm / 90W	2260mm	Acet. Nat./Anodized	P.U. 330,00
011.0860WO.002.54	5700K / 3900Lm / 35W	860mm	BR/White	P.U. 147,00	011.2260WO.002.54	5700K / 10400Lm / 90W	2260mm	BR/White	P.U. 330,00
011.0860ACO.002.54	5700K / 3900Lm / 35W	860mm	Acet. Nat./ Nat.Satin	P.U. 147,00	011.2260ACO.002.54	5700K / 10400Lm / 90W	2260mm	Acet. Nat./Anodized	P.U. 330,00
011.1140WO.002.82	2700K / 4900Lm / 45W	1140mm	BR/White	P.U. 172,00	011.2540WO.002.82	2700K / 11000Lm / 100W	2540mm	BR/White	P.U. 348,00
011.1140ACO.002.82	2700K / 4900Lm / 45W	1140mm	Acet. Nat./ Nat. Satin	P.U. 172,00	011.2540ACO.002.82	2700K / 11000Lm / 100W	2540mm	Acet. Nat./Anodized	P.U. 348,00
011.1140WO.002.84	4000K / 5050Lm / 45W	1140mm	BR/White	P.U. 172,00	011.2540WO.002.84	4000K / 11350Lm / 100W	2540mm	BR/White	P.U. 348,00
011.1140ACO.002.84	4000K / 5050Lm / 45W	1140mm	Acet. Nat./ Nat.Satin	P.U. 172,00	011.2540ACO.002.84	4000K / 11350Lm / 100W	2540mm	Acet. Nat./Anodized	P.U. 348,00
011.1140WO.002.54	5700K / 5200Lm / 45W	1140mm	BR/White	P.U. 172,00	011.2540WO.002.54	5700K / 11700Lm / 100W	2540mm	BR/White	P.U. 348,00
011.1140ACO.002.54	5700K / 5200Lm / 45W	1140mm	Acet. Nat./ Nat. Satin	P.U. 172,00	011.2540ACO.002.54	5700K / 11700Lm / 100W	2540mm	Acet. Nat./Anodized	P.U. 348,00
011.1420WO.002.82	2700K / 6100Lm / 55W	1420mm	BR/White	P.U. 186,00	011.2820WO.002.82	2700K / 12200Lm / 110W	2820mm	BR/White	P.U. 370,00
011.1420ACO.002.82	2700K / 6100Lm / 55W	1420mm	Acet. Nat./ Nat. Satin	P.U. 186,00	011.2820ACO.002.82	2700K / 12200Lm / 110W	2820mm	Acet. Nat./Anodized	P.U. 370,00
011.1420WO.002.84	4000K / 6300Lm / 55W	1420mm	BR/White	P.U. 186,00	011.2820WO.002.84	4000K / 12600Lm / 110W	2820mm	BR/White	P.U. 370,00
011.1420ACO.002.84	4000K / 6300Lm / 55W	1420mm	Acet. Nat./ Nat. Satin	P.U. 186,00	011.2820ACO.002.84	4000K / 12600Lm / 110W	2820mm	Acet. Nat./Anodized	P.U. 370,00
011.1420WO.002.54	5700K / 6500Lm / 55W	1420mm	BR/White	P.U. 186,00	011.2820WO.002.54	5700K / 13050Lm / 110W	2820mm	BR/White	P.U. 370,00
011.1420ACO.002.54	5700K / 6500Lm / 55W	1420mm	Acet. Nat./Anodized	P.U. 186,00	011.2820ACO.002.54	5700K / 13050Lm / 110W	2820mm	Acet. Nat./Anodized	P.U. 370,00
011.1700WO.002.82	2700K / 7300Lm / 65W	1700mm	BR/White	P.U. 210,00					
011.1700ACO.002.82	2700K / 7300Lm / 65W	1700mm	Acet. Nat./ Nat. Satin	P.U. 210,00					
011.1700WO.002.84	4000K / 7600Lm / 65W	1700mm	BR/White	P.U. 210,00					
011.1700ACO.002.84	4000K / 7600Lm / 65W	1700mm	Acet. Nat./ Nat. Satin	P.U. 210,00					
011.1700WO.002.54	5700K / 7850Lm / 65W	1700mm	BR/White	P.U. 210,00					
011.1700ACO.002.54	5700K / 7850Lm / 65W	1700mm	Acet. Nat./Anodized	P.U. 210,00					

Opções por Encomenda: Dimensões Específicas (mínimo 56mm) - Kit de Emergência - DALI - Dimável - Sistema de controle de iluminação (lux contol)

Obs: Não ligar com Sensores

Devido à constante evolução deste tipo de produtos a marca dos Led's e Drivers assim como as características técnicas podem ser alterados sem aviso prévio, por favor consultar o folheto de solicite a ficha técnica actualizada dos artigos pretendidos.



Luminária em Alumínio Extrudido c/ Barra Led e Driver
Extruded Aluminium Equipped with Led PCB and Driver



Led: **OSRAM**

Driver: **MW** ou / or **TRIDONIC**

Placa Led 50 000 Horas; 5 Anos Garantia

Led PCB 50 000 Hours; 5 Years Warranty

Electrificado com barra Led (Osram) Simples (1 Linha)
Assembled with Osram Led (1 Led Line)

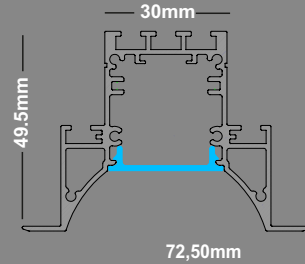

Rossio 72

Código/Code	Led / Lm / W	L	Cor/Color	€	Código/Code	Led / Lm / W	L	Cor/Color	€
012.0580WO.001.82	2700K / 1220Lm / 15W	580mm	BR/White	P.U. 125,00	012.1700WO.001.82	2700K / 3700Lm / 35W	1700mm	BR/White	P.U. 208,00
012.0580ACO.001.82	2700K / 1220Lm / 15W	580mm	Acet. Nat./ Nat.Satin	P.U. 125,00	012.1700ACO.001.82	2700K / 3700Lm / 35W	1700mm	Acet. Nat./Anodized	P.U. 208,00
012.0580WO.001.84	4000K / 1300Lm / 15W	580mm	BR/White	P.U. 125,00	012.1700WO.001.84	4000K / 3800Lm / 35W	1700mm	BR/White	P.U. 208,00
012.0580ACO.001.84	4000K / 1300Lm / 15W	580mm	Acet. Nat./ Nat.Satin	P.U. 125,00	012.1700ACO.001.84	4000K / 3800Lm / 35W	1700mm	Acet. Nat./Anodized	P.U. 208,00
012.0580WO.001.54	5700K / 1350Lm / 15W	580mm	BR/White	P.U. 125,00	012.1700WO.001.54	5700K / 3900Lm / 35W	1700mm	BR/White	P.U. 208,00
012.0580ACO.001.54	5700K / 1350Lm / 15W	580mm	Acet. Nat./ Nat.Satin	P.U. 125,00	012.1700ACO.001.54	5700K / 3900Lm / 35W	1700mm	Acet. Nat./Anodized	P.U. 208,00
012.0860WO.001.82	2700K / 1850Lm / 20W	860mm	BR/White	P.U. 140,00	012.1980WO.001.82	2700K / 4300Lm / 40W	1980mm	BR/White	P.U. 230,00
012.0860ACO.001.82	2700K / 1850Lm / 20W	860mm	Acet. Nat./ Nat.Satin	P.U. 140,00	012.1980ACO.001.82	2700K / 4300Lm / 40W	1980mm	Acet. Nat./Anodized	P.U. 230,00
012.0860WO.001.84	4000K / 1900Lm / 20W	860mm	BR/White	P.U. 140,00	012.1980WO.001.84	4000K / 4450Lm / 40W	1980mm	BR/White	P.U. 230,00
012.0860ACO.001.84	4000K / 1900Lm / 20W	860mm	Acet. Nat./ Nat.Satin	P.U. 140,00	012.1980ACO.001.84	4000K / 4450Lm / 40W	1980mm	Acet. Nat./Anodized	P.U. 230,00
012.0860WO.001.54	5700K / 1950Lm / 20W	860mm	BR/White	P.U. 140,00	012.1980WO.001.54	5700K / 4550Lm / 40W	1980mm	BR/White	P.U. 230,00
012.0860ACO.001.54	5700K / 1950Lm / 20W	860mm	Acet. Nat./ Nat.Satin	P.U. 140,00	012.1980ACO.001.54	5700K / 4550Lm / 40W	1980mm	Acet. Nat./Anodized	P.U. 230,00
012.1140WO.001.82	2700K / 2450Lm / 25W	1140mm	BR/White	P.U. 171,00	012.2260WO.001.82	2700K / 4900Lm / 45W	2260mm	BR/White	P.U. 250,00
012.1140ACO.001.82	2700K / 2450Lm / 25W	1140mm	Acet. Nat./ Nat. Satin	P.U. 171,00	012.2260ACO.001.82	2700K / 4900Lm / 45W	2260mm	Acet. Nat./Anodized	P.U. 250,00
012.1140WO.001.84	4000K / 2550Lm / 25W	1140mm	BR/White	P.U. 171,00	012.2260WO.001.84	4000K / 5050Lm / 45W	2260mm	BR/White	P.U. 250,00
012.1140ACO.001.84	4000K / 2550Lm / 25W	1140mm	Acet. Nat./ Nat.Satin	P.U. 171,00	012.2260ACO.001.84	4000K / 5050Lm / 45W	2260mm	Acet. Nat./Anodized	P.U. 250,00
012.1140WO.001.54	5700K / 2650Lm / 25W	1140mm	BR/White	P.U. 171,00	012.2260WO.001.54	5700K / 5200Lm / 45W	2260mm	BR/White	P.U. 250,00
012.1140ACO.001.54	5700K / 2650Lm / 25W	1140mm	Acet. Nat./ Nat. Satin Antr./Dark Grey	P.U. 171,00	012.2260ACO.001.54	5700K / 5200Lm / 45W	2260mm	Acet. Nat./Anodized	P.U. 250,00
012.1420WO.001.82	2700K / 3050Lm / 30W	1420mm	BR/White	P.U. 186,00	012.2540WO.001.82	2700K / 5500Lm / 50W	2540mm	BR/White	P.U. 265,00
012.1420ACO.001.82	2700K / 3050Lm / 30W	1420mm	Acet. Nat./ Nat. Satin	P.U. 186,00	012.2540ACO.001.82	2700K / 5500Lm / 50W	2540mm	Acet. Nat./Anodized	P.U. 265,00
012.1420WO.001.84	4000K / 3150Lm / 30W	1420mm	BR/White	P.U. 186,00	012.2540WO.001.84	4000K / 5700Lm / 50W	2540mm	BR/White	P.U. 265,00
012.1420ACO.001.84	4000K / 3150Lm / 30W	1420mm	Acet. Nat./ Nat. Satin	P.U. 186,00	012.2540ACO.001.84	4000K / 5700Lm / 50W	2540mm	Acet. Nat./Anodized	P.U. 265,00
012.1420WO.001.54	5700K / 3250Lm / 30W	1420mm	BR/White	P.U. 186,00	012.2540WO.001.54	5700K / 5900Lm / 50W	2540mm	BR/White	P.U. 265,00
012.1420ACO.001.54	5700K / 3250Lm / 30W	1420mm	Acet. Nat./Anodized	P.U. 186,00	012.2540ACO.001.54	5700K / 5900Lm / 50W	2540mm	Acet. Nat./Anodized	P.U. 265,00
					012.2820WO.001.82	2700K / 6100Lm / 55W	2820mm	BR/White	P.U. 295,00
					012.2820ACO.001.82	2700K / 6100Lm / 55W	2820mm	Acet. Nat./Anodized	P.U. 295,00
					012.2820WO.001.84	4000K / 6300Lm / 55W	2820mm	BR/White	P.U. 295,00
					012.2820ACO.001.84	4000K / 6300Lm / 55W	2820mm	Acet. Nat./Anodized	P.U. 295,00
					012.2820WO.001.54	5700K / 6500Lm / 55W	2820mm	BR/White	P.U. 295,00
					012.2820ACO.001.54	5700K / 6500Lm / 55W	2820mm	Acet. Nat./Anodized	P.U. 295,00

Opções por Encomenda: Dimensões Específicas (mínimo 56mm) - Kit de Emergência - DALI - Dimável - Sistema de controle de Iluminação (lux contol)

Obs: Não ligar com Sensores

Devido à constante evolução deste tipo de produtos a marca dos Leds e Drivers assim como as características técnicas podem ser alterados sem aviso prévio, por favor consultar o folheto ou solicitar a ficha técnica actualizada dos artigos pretendidos

Luminária em Alumínio Extrudido c/ Barra Led e Driver
Extruded Aluminium Equipped with Led PCB and Driver



Led: **OSRAM**

Driver: **MW** ou / or **TRIDONIC**

Placa Led 50 000 Horas; 5 Anos Garantia

Led PCB 50 000 Hours; 5 Years Warranty

Electrificado com barra Led (Osram) Simples (1 Linha)
Assembled with Osram Led (1 Led Line)

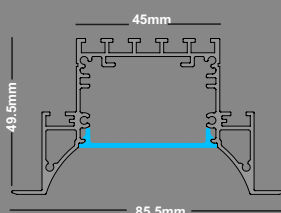

Rossio 85

Código/Code	Led / Lm / W	L	Cor/Color	€	Código/Code	Led / Lm / W	L	Cor/Color	€
013.0580WO.001.82	2700K / 1220Lm / 15W	580mm	BR/White	P.U. 125,00	013.1980WO.001.82	2700K / 4300Lm / 40W	1980mm	BR/White	P.U. 235,00
013.0580ACO.001.82	2700K / 1220Lm / 15W	580mm	Acet. Nat./ Nat.Satin	P.U. 125,00	013.1980ACO.001.82	2700K / 4300Lm / 40W	1980mm	Acet. Nat./Anodized	P.U. 235,00
013.0580WO.001.84	4000K / 1300Lm / 15W	580mm	BR/White	P.U. 125,00	013.1980WO.001.84	4000K / 4450Lm / 40W	1980mm	BR/White	P.U. 235,00
013.0580ACO.001.84	4000K / 1300Lm / 15W	580mm	Acet. Nat./ Nat.Satin	P.U. 125,00	013.1980ACO.001.84	4000K / 4450Lm / 40W	1980mm	Acet. Nat./Anodized	P.U. 235,00
013.0580WO.001.54	5700K / 1300Lm / 15W	580mm	BR/White	P.U. 125,00	013.1980WO.001.54	5700K / 4550Lm / 40W	1980mm	BR/White	P.U. 235,00
013.0580ACO.001.54	5700K / 3150Lm / 15W	580mm	Acet. Nat./ Nat.Satin	P.U. 125,00	013.1980ACO.001.54	5700K / 4550Lm / 40W	1980mm	Acet. Nat./Anodized	P.U. 235,00
013.0860WO.001.82	2700K / 1850Lm / 20W	860mm	BR/White	P.U. 145,00	013.2260WO.001.82	2700K / 4900Lm / 45W	2260mm	BR/White	P.U. 255,00
013.0860ACO.001.82	2700K / 1850Lm / 20W	860mm	Acet. Nat./ Nat.Satin	P.U. 145,00	013.2260ACO.001.82	2700K / 4900Lm / 45W	2260mm	Acet. Nat./Anodized	P.U. 255,00
013.0860WO.001.84	4000K / 1900Lm / 20W	860mm	BR/White	P.U. 145,00	013.2260WO.001.84	4000K / 5050Lm / 45W	2260mm	BR/White	P.U. 255,00
013.0860ACO.001.84	4000K / 1900Lm / 20W	860mm	Acet. Nat./ Nat.Satin	P.U. 145,00	013.2260ACO.001.84	4000K / 5050Lm / 45W	2260mm	Acet. Nat./Anodized	P.U. 255,00
013.0860WO.001.54	5700K / 1950Lm / 20W	860mm	BR/White	P.U. 145,00	013.2260WO.001.54	5700K / 5200Lm / 45W	2260mm	BR/White	P.U. 255,00
013.0860ACO.001.54	5700K / 1950Lm / 20W	860mm	Acet. Nat./ Nat.Satin	P.U. 145,00	013.2260ACO.001.54	5700K / 5200Lm / 45W	2260mm	Acet. Nat./Anodized	P.U. 255,00
013.1140WO.001.82	2700K / 2450Lm / 25W	1140mm	BR/White	P.U. 175,00	013.2540WO.001.82	2700K / 5500Lm / 50W	2540mm	BR/White	P.U. 275,00
013.1140ACO.001.82	2700K / 2450Lm / 25W	1140mm	Acet. Nat./ Nat. Satin	P.U. 175,00	013.2540ACO.001.82	2700K / 5500Lm / 50W	2540mm	Acet. Nat./Anodized	P.U. 275,00
013.1140WO.001.84	4000K / 2550Lm / 25W	1140mm	BR/White	P.U. 175,00	013.2540WO.001.84	4000K / 5700Lm / 50W	2540mm	BR/White	P.U. 275,00
013.1140ACO.001.84	4000K / 2550Lm / 25W	1140mm	Acet. Nat./ Nat.Satin	P.U. 175,00	013.2540ACO.001.84	4000K / 5700Lm / 50W	2540mm	Acet. Nat./Anodized	P.U. 275,00
013.1140WO.001.54	5700K / 2650Lm / 25W	1140mm	BR/White	P.U. 175,00	013.2540WO.001.54	5700K / 5900Lm / 50W	2540mm	BR/White	P.U. 275,00
013.1140ACO.001.54	5700K / 2650Lm / 25W	1140mm	Acet. Nat./ Nat. Satin	P.U. 175,00	013.2540ACO.001.54	5700K / 5900Lm / 50W	2540mm	Acet. Nat./Anodized	P.U. 275,00
013.1420WO.001.82	2700K / 3050Lm / 30W	1420mm	BR/White	P.U. 190,00	013.2820WO.001.82	2700K / 6100Lm / 55W	2820mm	BR/White	P.U. 300,00
013.1420ACO.001.82	2700K / 3050Lm / 30W	1420mm	Acet. Nat./ Nat. Satin	P.U. 190,00	013.2820ACO.001.82	2700K / 6100Lm / 55W	2820mm	Acet. Nat./Anodized	P.U. 300,00
013.1420WO.001.84	4000K / 3150Lm / 30W	1420mm	BR/White	P.U. 190,00	013.2820WO.001.84	4000K / 6300Lm / 55W	2820mm	BR/White	P.U. 300,00
013.1420ACO.001.84	4000K / 3150Lm / 30W	1420mm	Acet. Nat./ Nat. Satin	P.U. 190,00	013.2820ACO.001.84	4000K / 6300Lm / 55W	2820mm	Acet. Nat./Anodized	P.U. 300,00
013.1420WO.001.54	5700K / 3250Lm / 30W	1420mm	BR/White	P.U. 190,00	013.2820WO.001.54	5700K / 6500Lm / 55W	2820mm	BR/White	P.U. 300,00
013.1420ACO.001.54	5700K / 3250Lm / 30W	1420mm	Acet. Nat./Anodized	P.U. 190,00	013.2820ACO.001.54	5700K / 6500Lm / 55W	2820mm	Acet. Nat./Anodized	P.U. 300,00
013.1700WO.001.82	2700K / 3700Lm / 35W	1700mm	BR/White	P.U. 215,00					
013.1700ACO.001.82	2700K / 3700Lm / 35W	1700mm	Acet. Nat./ Nat. Satin	P.U. 215,00					
013.1700WO.001.84	4000K / 3800Lm / 35W	1700mm	BR/White	P.U. 215,00					
013.1700ACO.001.84	4000K / 3800Lm / 35W	1700mm	Acet. Nat./ Nat. Satin	P.U. 215,00					
013.1700WO.001.54	5700K / 3900Lm / 35W	1700mm	BR/White	P.U. 215,00					
013.1700ACO.001.54	5700K / 3900Lm / 35W	1700mm	Acet. Nat./Anodized	P.U. 215,00					

Opções por Encomenda: Dimensões Específicas (mínimo 56mm) - Kit de Emergência - DALI - Dimável - Sistema de controle de Iluminação (lux contol)

Obs: Não ligar com Sensores

Devido à constante evolução deste tipo de produtos a marca dos Led's e Drivers assim como as características técnicas podem ser alterados sem aviso prévio, por favor consultar o folheto de solicitação e ficha técnica actualizada dos artigos pretendidos.



Luminária em Alumínio Extrudido c/ Barra Led e Driver
 Extruded Aluminium Equipped with Led PCB and Driver

Led: **OSRAM**

Driver: **MW** ou / or **TRIDONIC**

Placa Led 50 000 Horas; 5 Anos Garantia

Led PCB 50 000 Hours; 5 Years Warranty



Electrificado com barra Led (**Osram**) Dupla (2 Linhas)
 Assembled with **Osram** Led (2 Led Line)

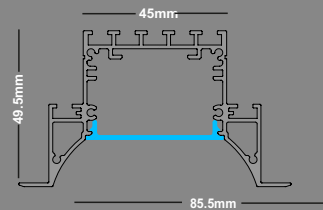

Rossio 85

Código/Code	Led / Lm / W	L	Cor/Color	€	Código/Code	Led / Lm / W	L	Cor/Color	€
013.0580WO.002.82	2700K / 2450Lm / 25W	580mm	BR/White	P.U. 140,00	013.1980W.O.002.82	2700K / 8550Lm / 75W	1980mm	BR/White	P.U. 330,00
013.0580ACO.002.82	2700K / 2450Lm / 25W	580mm	Acet. Nat./ Nat.Satin	P.U. 140,00	013.1980ACO.002.82	2700K / 8550Lm / 75W	1980mm	Acet. Nat./Anodized	P.U. 330,00
013.0580WO.002.84	4000K / 2550Lm / 25W	580mm	BR/White	P.U. 140,00	013.1980WO.002.84	4000K / 8850Lm / 75W	1980mm	BR/White	P.U. 330,00
013.0580ACO.002.84	4000K / 2550Lm / 25W	580mm	Acet. Nat./ Nat.Satin	P.U. 140,00	013.1980ACO.002.84	4000K / 8850Lm / 75W	1980mm	Acet. Nat./Anodized	P.U. 330,00
013.0580WO.002.54	5700K / 2620Lm / 25W	580mm	BR/White	P.U. 140,00	013.1980WO.002.54	5700K / 9150Lm / 75W	1980mm	BR/White	P.U. 330,00
013.0580ACO.002.54	5700K / 2620Lm / 25W	580mm	Acet. Nat./ Nat.Satin	P.U. 140,00	013.1980ACO.002.54	5700K / 9150Lm / 75W	1980mm	Acet. Nat./Anodized	P.U. 330,00
013.0860WO.002.82	2700K / 3700Lm / 35W	860mm	BR/White	P.U. 160,00	013.2260WO.002.82	2700K / 9750Lm / 90W	2260mm	BR/White	P.U. 355,00
013.0860ACO.002.82	2700K / 3700Lm / 35W	860mm	Acet. Nat./ Nat.Satin	P.U. 160,00	013.2260ACO.002.82	2700K / 9750Lm / 90W	2260mm	Acet. Nat./Anodized	P.U. 355,00
013.0860WO.002.84	4000K / 3800Lm / 35W	860mm	BR/White	P.U. 160,00	013.2260WO.002.84	4000K / 10100Lm / 90W	2260mm	BR/White	P.U. 355,00
013.0860ACO.002.84	4000K / 3800Lm / 35W	860mm	Acet. Nat./ Nat.Satin	P.U. 160,00	013.2260ACO.002.84	4000K / 10100Lm / 90W	2260mm	Acet. Nat./Anodized	P.U. 355,00
013.0860WO.002.54	5700K / 3900Lm / 35W	860mm	BR/White	P.U. 160,00	013.2260WO.002.54	5700K / 10400Lm / 90W	2260mm	BR/White	P.U. 355,00
013.0860ACO.002.54	5700K / 3900Lm / 35W	860mm	Acet. Nat./ Nat.Satin	P.U. 160,00	013.2260ACO.002.54	5700K / 10400Lm / 90W	2260mm	Acet. Nat./Anodized	P.U. 355,00
013.1140WO.002.82	2700K / 4900Lm / 45W	1140mm	BR/White	P.U. 190,00	013.2540WO.002.82	2700K / 11000Lm / 100W	2540mm	BR/White	P.U. 380,00
013.1140ACO.002.82	2700K / 4900Lm / 45W	1140mm	Acet. Nat./ Nat. Satin	P.U. 190,00	013.2540ACO.002.82	2700K / 11000Lm / 100W	2540mm	Acet. Nat./Anodized	P.U. 380,00
013.1140WO.002.84	4000K / 5050Lm / 45W	1140mm	BR/White	P.U. 190,00	013.2540WO.002.84	4000K / 11350Lm / 100W	2540mm	BR/White	P.U. 380,00
013.1140ACO.002.84	4000K / 5050Lm / 45W	1140mm	Acet. Nat./ Nat.Satin	P.U. 190,00	013.2540ACO.002.84	4000K / 11350Lm / 100W	2540mm	Acet. Nat./Anodized	P.U. 380,00
013.1140WO.002.54	5700K / 5200Lm / 45W	1140mm	BR/White	P.U. 190,00	013.2540WO.002.54	5700K / 11700Lm / 100W	2540mm	BR/White	P.U. 380,00
013.1140ACO.002.54	5700K / 5200Lm / 45W	1140mm	Acet. Nat./ Nat. Satin	P.U. 190,00	013.2540ACO.002.54	5700K / 11700Lm / 100W	2540mm	Acet. Nat./Anodized	P.U. 380,00
013.1420WO.002.82	2700K / 6100Lm / 55W	1420mm	BR/White	P.U. 205,00	013.2820WO.002.82	2700K / 12200Lm / 110W	2820mm	BR/White	P.U. 405,00
013.1420ACO.002.82	2700K / 6100Lm / 55W	1420mm	Acet. Nat./ Nat. Satin	P.U. 205,00	013.2820ACO.002.82	2700K / 12200Lm / 110W	2820mm	Acet. Nat./Anodized	P.U. 405,00
013.1420WO.002.84	4000K / 6300Lm / 55W	1420mm	BR/White	P.U. 205,00	013.2820WO.002.84	4000K / 12600Lm / 110W	2820mm	BR/White	P.U. 405,00
013.1420ACO.002.84	4000K / 6300Lm / 55W	1420mm	Acet. Nat./ Nat. Satin	P.U. 205,00	013.2820ACO.002.84	4000K / 12600Lm / 110W	2820mm	Acet. Nat./Anodized	P.U. 405,00
013.1420WO.002.54	5700K / 6500Lm / 55W	1420mm	BR/White	P.U. 205,00	013.2820WO.002.54	5700K / 13050Lm / 110W	2820mm	BR/White	P.U. 405,00
013.1420ACO.002.54	5700K / 6500Lm / 55W	1420mm	Acet. Nat./Anodized	P.U. 205,00	013.2820ACO.002.54	5700K / 13050Lm / 110W	2820mm	Acet. Nat./Anodized	P.U. 405,00
013.1700WO.002.82	2700K / 7300Lm / 65W	1700mm	BR/White	P.U. 230,00					
013.1700ACO.002.82	2700K / 7300Lm / 65W	1700mm	Acet. Nat./ Nat. Satin	P.U. 230,00					
013.1700WO.002.84	4000K / 7600Lm / 65W	1700mm	BR/White	P.U. 230,00					
013.1700ACO.002.84	4000K / 7600Lm / 65W	1700mm	Acet. Nat./ Nat. Satin	P.U. 230,00					
013.1700WO.002.54	5700K / 7850Lm / 65W	1700mm	BR/White	P.U. 230,00					
013.1700ACO.002.54	5700K / 7850Lm / 65W	1700mm	Acet. Nat./Anodized Antr./Dark Grey	P.U. 230,00					

Opções por Encomenda: Dimensões Específicas (mínimo 56mm) - Kit de Emergência - DALI - Dimável - Sistema de controle de Iluminação (lux contol)

Obs: Não ligar com Sensores

Devido à constante evolução deste tipo de produtos a marca dos Led's e Drivers assim como as características técnicas podem ser alterados sem aviso prévio, por favor consultar o folheto ou solicitar a ficha técnica atualizada dos artigos pretendidos.

Luminária em Alumínio Extrudido c/ Barra Led e Driver
Extruded Aluminium Equipped with Led PCB and Driver



Led: **OSRAM**

Driver: **AMW** ou / or **TRIDONIC**

Placa Led 50 000 Horas; 5 Anos Garantia

Led PCB 50 000 Hours; 5 Years Warranty

Electrificado com barra Led (Osram) Simples (1 Linha)
Assembled with Osram Led (1 Led Line)

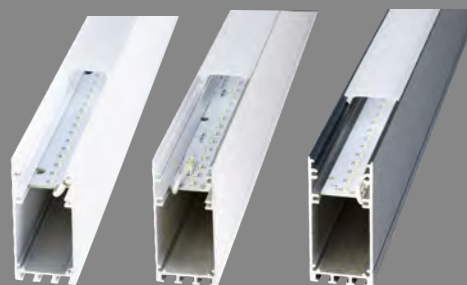
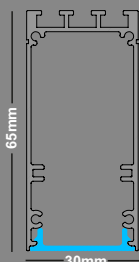

Areiro 30

Código/Code	Led / Lm / W	L	Cor/Color	€	Código/Code	Led / Lm / W	L	Cor/Color	€
014.0580WO.001.82	2700K / 1220Lm / 15W	580mm	BR/White	P.U. 115,00	014.1700WO.001.82	2700K / 3700Lm / 35W	1700mm	BR/White	P.U. 195,00
014.0580ACO.001.82	2700K / 1220Lm / 15W	580mm	Acet. Nat./ Nat.Satin	P.U. 115,00	014.1700ACO.001.82	2700K / 3700Lm / 35W	1700mm	Acet. Nat./Anodized	P.U. 195,00
014.0580ANO.001.82	2700K / 1220Lm / 15W	580mm	Antr./Dark Grey	P.U. 115,00	014.1700ANO.001.82	2700K / 3700Lm / 35W	1700mm	Antr./Dark Grey	P.U. 195,00
014.0580WO.001.84	4000K / 1300Lm / 15W	580mm	BR/White	P.U. 115,00	014.1700WO.001.84	4000K / 3800Lm / 35W	1700mm	BR/White	P.U. 195,00
014.0580ACO.001.84	4000K / 1300Lm / 15W	580mm	Acet. Nat./ Nat.Satin	P.U. 115,00	014.1700ACO.001.84	4000K / 3800Lm / 35W	1700mm	Acet. Nat./Anodized	P.U. 195,00
014.0580ANO.001.84	4000K / 1300Lm / 15W	580mm	Antr./Dark Grey	P.U. 115,00	014.1700ANO.001.84	4000K / 3800Lm / 35W	1700mm	Antr./Dark Grey	P.U. 195,00
014.0580WO.001.54	5700K / 1350Lm / 15W	580mm	BR/White	P.U. 115,00	014.1700WO.001.54	5700K / 3900Lm / 35W	1700mm	BR/White	P.U. 195,00
014.0580ACO.001.54	5700K / 1350Lm / 15W	580mm	Acet. Nat./ Nat.Satin	P.U. 115,00	014.1700ACO.001.54	5700K / 3900Lm / 35W	1700mm	Acet. Nat./Anodized	P.U. 195,00
014.0580ANO.001.54	5700K / 1350Lm / 15W	580mm	Antr./Dark Grey	P.U. 115,00	014.1700ANO.001.54	5700K / 3900Lm / 35W	1700mm	Antr./Dark Grey	P.U. 195,00
014.0860WO.001.82	2700K / 1850Lm / 20W	860mm	BR/White	P.U. 130,00	014.1980WO.001.82	2700K / 4300Lm / 40W	1980mm	BR/White	P.U. 210,00
014.0860ACO.001.82	2700K / 1850Lm / 20W	860mm	Acet. Nat./ Nat.Satin	P.U. 130,00	014.1980ACO.001.82	2700K / 4300Lm / 40W	1980mm	Acet. Nat./Anodized	P.U. 210,00
014.0860ANO.001.82	2700K / 1850Lm / 20W	860mm	Antr./Dark Grey	P.U. 130,00	014.1980ANO.001.82	2700K / 4300Lm / 40W	1980mm	Antr./Dark Grey	P.U. 210,00
014.0860WO.001.84	4000K / 1900Lm / 20W	860mm	BR/White	P.U. 130,00	014.1980WO.001.84	4000K / 4450Lm / 40W	1980mm	BR/White	P.U. 210,00
014.0860ACO.001.84	4000K / 1900Lm / 20W	860mm	Acet. Nat./ Nat.Satin	P.U. 130,00	014.1980ACO.001.84	4000K / 4450Lm / 40W	1980mm	Acet. Nat./Anodized	P.U. 210,00
014.0860ANO.001.84	4000K / 1900Lm / 20W	860mm	Antr./Dark Grey	P.U. 130,00	014.1980ANO.001.84	4000K / 4450Lm / 40W	1980mm	Antr./Dark Grey	P.U. 210,00
014.0860WO.001.54	5700K / 1900Lm / 20W	860mm	BR/White	P.U. 130,00	014.1980WO.001.54	5700K / 4550Lm / 40W	1980mm	BR/White	P.U. 210,00
014.0860ACO.001.54	5700K / 1900Lm / 20W	860mm	Acet. Nat./ Nat.Satin	P.U. 130,00	014.1980ACO.001.54	5700K / 4550Lm / 40W	1980mm	Acet. Nat./Anodized	P.U. 210,00
014.0860ANO.001.54	5700K / 1900Lm / 20W	860mm	Antr./Dark Grey	P.U. 130,00	014.1980ANO.001.54	5700K / 4550Lm / 40W	1980mm	Antr./Dark Grey	P.U. 210,00
014.1140WO.001.82	2700K / 2450Lm / 25W	1140mm	BR/White	P.U. 160,00	014.2260WO.001.82	2700K / 4900Lm / 45W	2260mm	BR/White	P.U. 230,00
014.1140ACO.001.82	2700K / 2450Lm / 25W	1140mm	Acet. Nat./ Nat. Satin	P.U. 160,00	014.2260ACO.001.82	2700K / 4900Lm / 45W	2260mm	Acet. Nat./Anodized	P.U. 230,00
014.1140ANO.001.82	2700K / 2450Lm / 25W	1140mm	Antr./Dark Grey	P.U. 160,00	014.2260ANO.001.82	2700K / 4900Lm / 45W	2260mm	Antr./Dark Grey	P.U. 230,00
014.1140WO.001.84	4000K / 2550Lm / 25W	1140mm	BR/White	P.U. 160,00	014.2260WO.001.84	4000K / 5050Lm / 45W	2260mm	BR/White	P.U. 230,00
014.1140ACO.001.84	4000K / 2550Lm / 25W	1140mm	Acet. Nat./ Nat.Satin	P.U. 160,00	014.2260ACO.001.84	4000K / 5050Lm / 45W	2260mm	Acet. Nat./Anodized	P.U. 230,00
014.1140ANO.001.84	4000K / 2550Lm / 25W	1140mm	Antr./Dark Grey	P.U. 160,00	014.2260ANO.001.84	4000K / 5050Lm / 45W	2260mm	Antr./Dark Grey	P.U. 230,00
014.1140WO.001.54	5700K / 2650Lm / 25W	1140mm	BR/White	P.U. 160,00	014.2260WO.001.54	5700K / 5200Lm / 45W	2260mm	BR/White	P.U. 230,00
014.1140ACO.001.54	5700K / 2650Lm / 25W	1140mm	Acet. Nat./ Nat. Satin	P.U. 160,00	014.2260ACO.001.54	5700K / 5200Lm / 45W	2260mm	Acet. Nat./Anodized	P.U. 230,00
014.1140ANO.001.54	5700K / 2650Lm / 25W	1140mm	Antr./Dark Grey	P.U. 160,00	014.2260ANO.001.54	5700K / 5200Lm / 45W	2260mm	Antr./Dark Grey	P.U. 230,00
014.1420WO.001.82	2700K / 3050Lm / 30W	1420mm	BR/White	P.U. 175,00	014.2540WO.001.82	2700K / 5500Lm / 50W	2540mm	BR/White	P.U. 215,00
014.1420ACO.001.82	2700K / 3050Lm / 30W	1420mm	Acet. Nat./ Nat. Satin	P.U. 175,00	014.2540ACO.001.82	2700K / 5500Lm / 50W	2540mm	Acet. Nat./Anodized	P.U. 215,00
014.1420ANO.001.82	2700K / 3050Lm / 30W	1420mm	Antr./Dark Grey	P.U. 175,00	014.2540ANO.001.82	2700K / 5500Lm / 50W	2540mm	Antr./Dark Grey	P.U. 215,00
014.1420WO.001.84	4000K / 3150Lm / 30W	1420mm	BR/White	P.U. 175,00	014.2540WO.001.84	4000K / 5700Lm / 50W	2540mm	BR/White	P.U. 215,00
014.1420ACO.001.84	4000K / 3150Lm / 30W	1420mm	Acet. Nat./ Nat. Satin	P.U. 175,00	014.2540ACO.001.84	4000K / 5700Lm / 50W	2540mm	Acet. Nat./Anodized	P.U. 215,00
014.1420ANO.001.84	4000K / 3150Lm / 30W	1420mm	Antr./Dark Grey	P.U. 175,00	014.2540ANO.001.84	4000K / 5700Lm / 50W	2540mm	Antr./Dark Grey	P.U. 215,00
014.1420WO.001.54	5700K / 3250Lm / 30W	1420mm	BR/White	P.U. 175,00	014.2540WO.001.54	5700K / 5900Lm / 50W	2540mm	BR/White	P.U. 215,00
014.1420ACO.001.54	5700K / 3250Lm / 30W	1420mm	Acet. Nat./Anodized	P.U. 175,00	014.2540ACO.001.54	5700K / 5900Lm / 50W	2540mm	Acet. Nat./Anodized	P.U. 215,00
014.1420ANO.001.54	5700K / 3250Lm / 30W	1420mm	Antr./Dark Grey	P.U. 175,00	014.2540ANO.001.54	5700K / 5900Lm / 50W	2540mm	Antr./Dark Grey	P.U. 215,00
014.2820WO.001.82	2700K / 6100Lm / 55W	2820mm	BR/White	P.U. 265,00	014.2820WO.001.82	2700K / 6100Lm / 55W	2820mm	BR/White	P.U. 265,00
014.2820ACO.001.82	2700K / 6100Lm / 55W	2820mm	Acet. Nat./Anodized	P.U. 265,00	014.2820ACO.001.82	2700K / 6100Lm / 55W	2820mm	Acet. Nat./Anodized	P.U. 265,00
014.2820ANO.001.82	2700K / 6100Lm / 55W	2820mm	Antr./Dark Grey	P.U. 265,00	014.2820ANO.001.82	2700K / 6100Lm / 55W	2820mm	Antr./Dark Grey	P.U. 265,00
014.2820WO.001.84	4000K / 6300Lm / 55W	2820mm	BR/White	P.U. 265,00	014.2820WO.001.84	4000K / 6300Lm / 55W	2820mm	BR/White	P.U. 265,00
014.2820ACO.001.84	4000K / 6300Lm / 55W	2820mm	Acet. Nat./Anodized	P.U. 265,00	014.2820ACO.001.84	4000K / 6300Lm / 55W	2820mm	Acet. Nat./Anodized	P.U. 265,00
014.2820ANO.001.84	4000K / 6300Lm / 55W	2820mm	Antr./Dark Grey	P.U. 265,00	014.2820ANO.001.84	4000K / 6300Lm / 55W	2820mm	Antr./Dark Grey	P.U. 265,00
014.2820WO.001.54	5700K / 6500Lm / 55W	2820mm	BR/White	P.U. 265,00	014.2820WO.001.54	5700K / 6500Lm / 55W	2820mm	BR/White	P.U. 265,00
014.2820ACO.001.54	5700K / 6500Lm / 55W	2820mm	Acet. Nat./Anodized	P.U. 265,00	014.2820ACO.001.54	5700K / 6500Lm / 55W	2820mm	Acet. Nat./Anodized	P.U. 265,00
014.2820ANO.001.54	5700K / 6500Lm / 55W	2820mm	Antr./Dark Grey	P.U. 265,00	014.2820ANO.001.54	5700K / 6500Lm / 55W	2820mm	Antr./Dark Grey	P.U. 265,00

Opções por Encomenda: Dimensões Específicas (mínimo 56mm) - Kit de Emergência - DALI - Dimável - Sistema de controle de Iluminação (lux contol)

Obs: Não ligar com Sensores

Devido à constante evolução deste tipo de produtos a marca dos Led's e Drivers assim como as características técnicas podem ser alterados sem aviso prévio, por favor consultar o folheto ou solicitar a ficha técnica actualizada dos artigos preferências.



Luminária em Alumínio Extrudido c/ Barra Led e Driver
Extruded Aluminium Equipped with Led PCB and Driver

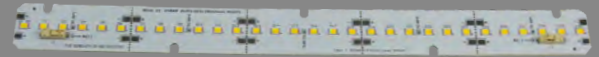

Led: **OSRAM**

Driver: **AMW** ou / or **TRIDONIC**

Placa Led 50 000 Horas; 5 Anos Garantia

Led PCB 50 000 Hours; 5 Years Warranty

Electrificado com barra Led (Osram) Simples (1 Linha)
Assembled with Osram Led (1 Led Line)

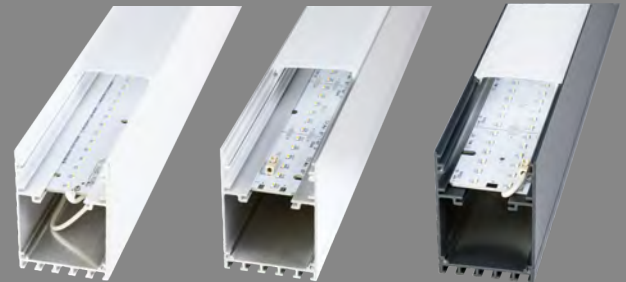
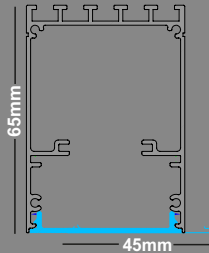

Areiro 45

Código/Code	Led / Lm / W	L	Cor/Color	€	Código/Code	Led / Lm / W	L	Cor/Color	€
015.0580WO.001.82	2700K / 1220Lm / 15W	580mm	BR/White	P.U. 120,00	015.1980WO.001.82	2700K / 4300Lm / 40W	1980mm	BR/White	P.U. 230,00
015.0580ACO.001.82	2700K / 1220Lm / 15W	580mm	Acet. Nat./ Nat.Satin	P.U. 120,00	015.1980ACO.001.82	2700K / 4300Lm / 40W	1980mm	Acet. Nat./Anodized	P.U. 230,00
015.0580ANO.001.82	2700K / 1220Lm / 15W	580mm	Antr./Dark Grey	P.U. 120,00	015.1980ANO.001.82	2700K / 4300Lm / 40W	1980mm	Antr./Dark Grey	P.U. 230,00
015.0580WO.001.84	4000K / 1300Lm / 15W	580mm	BR/White	P.U. 120,00	015.1980WO.001.84	4000K / 4450Lm / 40W	1980mm	BR/White	P.U. 230,00
015.0580ACO.001.84	4000K / 1300Lm / 15W	580mm	Acet. Nat./ Nat.Satin	P.U. 120,00	015.1980ACO.001.84	4000K / 4450Lm / 40W	1980mm	Acet. Nat./Anodized	P.U. 230,00
015.0580ANO.001.84	4000K / 1300Lm / 15W	580mm	Antr./Dark Grey	P.U. 120,00	015.1980ANO.001.84	4000K / 4450Lm / 40W	1980mm	Antr./Dark Grey	P.U. 230,00
015.0580WO.001.54	5700K / 1350Lm / 15W	580mm	BR/White	P.U. 120,00	015.1980WO.001.54	5700K / 4550Lm / 40W	1980mm	BR/White	P.U. 230,00
015.0580ACO.001.54	5700K / 1350Lm / 15W	580mm	Acet. Nat./ Nat.Satin	P.U. 120,00	015.1980ACO.001.54	5700K / 4550Lm / 40W	1980mm	Acet. Nat./Anodized	P.U. 230,00
015.0580ANO.001.54	5700K / 1350Lm / 15W	580mm	Antr./Dark Grey	P.U. 120,00	015.1980ANO.001.54	5700K / 4550Lm / 40W	1980mm	Antr./Dark Grey	P.U. 230,00
015.0860WO.001.82	2700K / 1850Lm / 20W	860mm	BR/White	P.U. 140,00	015.2260WO.001.82	2700K / 4900Lm / 45W	2260mm	BR/White	P.U. 250,00
015.0860ACO.001.82	2700K / 1850Lm / 20W	860mm	Acet. Nat./ Nat.Satin	P.U. 140,00	015.2260ACO.001.82	2700K / 4900Lm / 45W	2260mm	Acet. Nat./Anodized	P.U. 250,00
015.0860ANO.001.82	2700K / 1850Lm / 20W	860mm	Antr./Dark Grey	P.U. 140,00	015.2260ANO.001.82	2700K / 4900Lm / 45W	2260mm	Antr./Dark Grey	P.U. 250,00
015.0860WO.001.84	4000K / 1900Lm / 20W	860mm	BR/White	P.U. 140,00	015.2260WO.001.84	4000K / 5050Lm / 45W	2260mm	BR/White	P.U. 250,00
015.0860ACO.001.84	4000K / 1900Lm / 20W	860mm	Acet. Nat./ Nat.Satin	P.U. 140,00	015.2260ACO.001.84	4000K / 5050Lm / 45W	2260mm	Acet. Nat./Anodized	P.U. 250,00
015.0860ANO.001.84	4000K / 1900Lm / 20W	860mm	Antr./Dark Grey	P.U. 140,00	015.2260ANO.001.84	4000K / 5050Lm / 45W	2260mm	Antr./Dark Grey	P.U. 250,00
015.0860WO.001.54	5700K / 1950Lm / 20W	860mm	BR/White	P.U. 140,00	015.2260WO.001.54	5700K / 5200Lm / 45W	2260mm	BR/White	P.U. 250,00
015.0860ACO.001.54	5700K / 1950Lm / 20W	860mm	Acet. Nat./ Nat.Satin	P.U. 140,00	015.2260ACO.001.54	5700K / 5200Lm / 45W	2260mm	Acet. Nat./Anodized	P.U. 250,00
015.0860ANO.001.54	5700K / 1950Lm / 20W	860mm	Antr./Dark Grey	P.U. 140,00	015.2260ANO.001.54	5700K / 5200Lm / 45W	2260mm	Antr./Dark Grey	P.U. 250,00
015.1140WO.001.82	2700K / 2450Lm / 25W	1140mm	BR/White	P.U. 170,00	015.2540WO.001.82	2700K / 5500Lm / 50W	2540mm	BR/White	P.U. 270,00
015.1140ACO.001.82	2700K / 2450Lm / 25W	1140mm	Acet. Nat./ Nat. Satin	P.U. 170,00	015.2540ACO.001.82	2700K / 5500Lm / 50W	2540mm	Acet. Nat./Anodized	P.U. 270,00
015.1140ANO.001.82	2700K / 2450Lm / 25W	1140mm	Antr./Dark Grey	P.U. 170,00	015.2540ANO.001.82	2700K / 5500Lm / 50W	2540mm	Antr./Dark Grey	P.U. 270,00
015.1140WO.001.84	4000K / 2550Lm / 25W	1140mm	BR/White	P.U. 170,00	015.2540WO.001.84	4000K / 5700Lm / 50W	2540mm	BR/White	P.U. 270,00
015.1140ACO.001.84	4000K / 2550Lm / 25W	1140mm	Acet. Nat./ Nat.Satin	P.U. 170,00	015.2540ACO.001.84	4000K / 5700Lm / 50W	2540mm	Acet. Nat./Anodized	P.U. 270,00
015.1140ANO.001.84	4000K / 2550Lm / 25W	1140mm	Antr./Dark Grey	P.U. 170,00	015.2540ANO.001.84	4000K / 5700Lm / 50W	2540mm	Antr./Dark Grey	P.U. 270,00
015.1140WO.001.54	5700K / 2650Lm / 25W	1140mm	BR/White	P.U. 170,00	015.2540WO.001.54	5700K / 5900Lm / 50W	2540mm	BR/White	P.U. 270,00
015.1140ACO.001.54	5700K / 2650Lm / 25W	1140mm	Acet. Nat./ Nat. Satin	P.U. 170,00	015.2540ACO.001.54	5700K / 5900Lm / 50W	2540mm	Acet. Nat./Anodized	P.U. 270,00
015.1140ANO.001.54	5700K / 2650Lm / 25W	1140mm	Antr./Dark Grey	P.U. 170,00	015.2540ANO.001.54	5700K / 5900Lm / 50W	2540mm	Antr./Dark Grey	P.U. 270,00
015.1420WO.001.82	2700K / 3050Lm / 30W	1420mm	BR/White	P.U. 185,00	015.2820WO.001.82	2700K / 6100Lm / 55W	2820mm	BR/White	P.U. 290,00
015.1420ACO.001.82	2700K / 3050Lm / 30W	1420mm	Acet. Nat./ Nat. Satin	P.U. 185,00	015.2820ACO.001.82	2700K / 6100Lm / 55W	2820mm	Acet. Nat./Anodized	P.U. 290,00
015.1420ANO.001.82	2700K / 3050Lm / 30W	1420mm	Antr./Dark Grey	P.U. 185,00	015.2820ANO.001.82	2700K / 6100Lm / 55W	2820mm	Antr./Dark Grey	P.U. 290,00
015.1420WO.001.84	4000K / 3150Lm / 30W	1420mm	BR/White	P.U. 185,00	015.2820WO.001.84	4000K / 6300Lm / 55W	2820mm	BR/White	P.U. 290,00
015.1420ACO.001.84	4000K / 3150Lm / 30W	1420mm	Acet. Nat./ Nat. Satin	P.U. 185,00	015.2820ACO.001.84	4000K / 6300Lm / 55W	2820mm	Acet. Nat./Anodized	P.U. 290,00
015.1420ANO.001.84	4000K / 3150Lm / 30W	1420mm	Antr./Dark Grey	P.U. 185,00	015.2820ANO.001.84	4000K / 6300Lm / 55W	2820mm	Antr./Dark Grey	P.U. 290,00
015.1420WO.001.54	5700K / 3250Lm / 30W	1420mm	BR/White	P.U. 185,00	015.2820WO.001.54	5700K / 6500Lm / 55W	2820mm	BR/White	P.U. 290,00
015.1420ACO.001.54	5700K / 3250Lm / 30W	1420mm	Acet. Nat./Anodized	P.U. 185,00	015.2820ACO.001.54	5700K / 6500Lm / 55W	2820mm	Acet. Nat./Anodized	P.U. 290,00
015.1420ANO.001.54	5700K / 3250Lm / 30W	1420mm	Antr./Dark Grey	P.U. 185,00	015.2820ANO.001.54	5700K / 6500Lm / 55W	2820mm	Antr./Dark Grey	P.U. 290,00
015.1700WO.001.82	2700K / 3700Lm / 35W	1700mm	BR/White	P.U. 210,00					
015.1700ACO.001.82	2700K / 3700Lm / 35W	1700mm	Acet. Nat./ Nat. Satin	P.U. 210,00					
015.1700ANO.001.82	2700K / 3700Lm / 35W	1700mm	Antr./Dark Grey	P.U. 210,00					
015.1700WO.001.84	4000K / 3800Lm / 35W	1700mm	BR/White	P.U. 210,00					
015.1700ACO.001.84	4000K / 3800Lm / 35W	1700mm	Acet. Nat./ Nat. Satin	P.U. 210,00					
015.1700ANO.001.84	4000K / 3800Lm / 35W	1700mm	Antr./Dark Grey	P.U. 210,00					
015.1700WO.001.54	5700K / 3900Lm / 35W	1700mm	BR/White	P.U. 210,00					
015.1700ACO.001.54	5700K / 3900Lm / 35W	1700mm	Acet. Nat./Anodized	P.U. 210,00					
015.1700ANO.001.54	5700K / 3900Lm / 35W	1700mm	Antr./Dark Grey	P.U. 210,00					

Opções por Encomenda: Dimensões Específicas (mínimo 56mm) - Kit de Emergência - DALI - Dimável - Sistema de controle de Iluminação (lux contol)

Obs: Não ligar com Sensores

Devido à constante evolução deste tipo de produtos a marca dos Led's e Drivers assim como as características técnicas podem ser alterados sem aviso prévio, por favor consultar o folheto ou solicitar a ficha técnica actualizada dos artigos pretendidos.

Luminária em Alumínio Extrudido c/ Barra Led e Driver
Extruded Aluminium Equipped with Led PCB and Driver

Led: **OSRAM**

Driver: ou / or

Placa Led 50 000 Horas; 5 Anos Garantia
Led PCB 50 000 Hours; 5 Years Warranty



Electrificado com barra Led (**Osram**) Dupla (2 Linhas)
Assembled with **Osram** Led (2 Led Line)

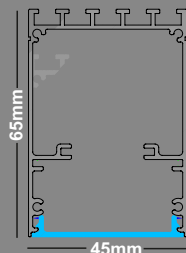

Areerio 45

Código/Code	Led / Lm / W	L	Cor/Color	€	Código/Code	Led / Lm / W	L	Cor/Color	€
015.0580WO.002.82	2700K / 2450Lm / 25W	580mm	BR/White	P.U. 135,00	015.1980WO.002.82	2700K / 8550Lm / 75W	1980mm	BR/White	P.U. 320,00
015.0580ACO.002.82	2700K / 2450Lm / 25W	580mm	Acet. Nat./ Nat.Satin	P.U. 135,00	015.1980ACO.002.82	2700K / 8550Lm / 75W	1980mm	Acet. Nat./Anodized	P.U. 320,00
015.0580ANO.002.82	2700K / 2450Lm / 25W	580mm	Antr./Dark Grey	P.U. 135,00	015.1980ANO.002.82	2700K / 8550Lm / 75W	1980mm	Antr./Dark Grey	P.U. 320,00
015.0580WO.002.84	4000K / 2550Lm / 25W	580mm	BR/White	P.U. 135,00	015.1980WO.002.84	4000K / 8850Lm / 75W	1980mm	BR/White	P.U. 320,00
015.0580ACO.002.84	4000K / 2550Lm / 25W	580mm	Acet. Nat./ Nat.Satin	P.U. 135,00	015.1980ACO.002.84	4000K / 8850Lm / 75W	1980mm	Acet. Nat./Anodized	P.U. 320,00
015.0580ANO.002.84	4000K / 2550Lm / 25W	580mm	Antr./Dark Grey	P.U. 135,00	015.1980ANO.002.84	4000K / 8850Lm / 75W	1980mm	Antr./Dark Grey	P.U. 320,00
015.0580WO.002.54	5700K / 2620Lm / 25W	580mm	BR/White	P.U. 135,00	015.1980WO.002.54	5700K / 9150Lm / 75W	1980mm	BR/White	P.U. 320,00
015.0580ACO.002.54	5700K / 2620Lm / 25W	580mm	Acet. Nat./ Nat.Satin	P.U. 135,00	015.1980ACO.002.54	5700K / 9150Lm / 75W	1980mm	Acet. Nat./Anodized	P.U. 320,00
015.0580ANO.002.54	5700K / 2620Lm / 25W	580mm	Antr./Dark Grey	P.U. 135,00	015.1980ANO.002.54	5700K / 9150Lm / 75W	1980mm	Antr./Dark Grey	P.U. 320,00
015.0860WO.002.82	2700K / 3700Lm / 35W	860mm	BR/White	P.U. 155,00	015.2260WO.002.82	2700K / 9750Lm / 90W	2260mm	BR/White	P.U. 350,00
015.0860ACO.002.82	2700K / 3700Lm / 35W	860mm	Acet. Nat./ Nat.Satin	P.U. 155,00	015.2260ACO.002.82	2700K / 9750Lm / 90W	2260mm	Acet. Nat./Anodized	P.U. 350,00
015.0860ANO.002.82	2700K / 3700Lm / 35W	860mm	Antr./Dark Grey	P.U. 155,00	015.2260ANO.002.82	2700K / 9750Lm / 90W	2260mm	Antr./Dark Grey	P.U. 350,00
015.0860WO.002.84	4000K / 3800Lm / 35W	860mm	BR/White	P.U. 155,00	015.2260WO.002.84	4000K / 10100Lm / 90W	2260mm	BR/White	P.U. 350,00
015.0860ACO.002.84	4000K / 3800Lm / 35W	860mm	Acet. Nat./ Nat.Satin	P.U. 155,00	015.2260ACO.002.84	4000K / 10100Lm / 90W	2260mm	Acet. Nat./Anodized	P.U. 350,00
015.0860ANO.002.84	4000K / 3800Lm / 35W	860mm	Antr./Dark Grey	P.U. 155,00	015.2260ANO.002.84	4000K / 10100Lm / 90W	2260mm	Antr./Dark Grey	P.U. 350,00
015.0860WO.002.54	5700K / 3900Lm / 35W	860mm	BR/White	P.U. 155,00	015.2260WO.002.54	5700K / 10400Lm / 90W	2260mm	BR/White	P.U. 350,00
015.0860ACO.002.54	5700K / 3900Lm / 35W	860mm	Acet. Nat./ Nat.Satin	P.U. 155,00	015.2260ACO.002.54	5700K / 10400Lm / 90W	2260mm	Acet. Nat./Anodized	P.U. 350,00
015.0860ANO.002.54	5700K / 3900Lm / 35W	860mm	Antr./Dark Grey	P.U. 155,00	015.2260ANO.002.54	5700K / 10400Lm / 90W	2260mm	Antr./Dark Grey	P.U. 350,00
015.1140WO.002.82	2700K / 4900Lm / 45W	1140mm	BR/White	P.U. 185,00	015.2540WO.002.82	2700K / 11000Lm / 100W	2540mm	BR/White	P.U. 370,00
015.1140ACO.002.82	2700K / 4900Lm / 45W	1140mm	Acet. Nat./ Nat. Satin	P.U. 185,00	015.2540ACO.002.82	2700K / 11000Lm / 100W	2540mm	Acet. Nat./Anodized	P.U. 370,00
015.1140ANO.002.82	2700K / 4900Lm / 45W	1140mm	Antr./Dark Grey	P.U. 185,00	015.2540ANO.002.82	2700K / 11000Lm / 100W	2540mm	Antr./Dark Grey	P.U. 370,00
015.1140WO.002.84	4000K / 5050Lm / 45W	1140mm	BR/White	P.U. 185,00	015.2540WO.002.84	4000K / 11350Lm / 100W	2540mm	BR/White	P.U. 370,00
015.1140ACO.002.84	4000K / 5050Lm / 45W	1140mm	Acet. Nat./ Nat.Satin	P.U. 185,00	015.2540ACO.002.84	4000K / 11350Lm / 100W	2540mm	Acet. Nat./Anodized	P.U. 370,00
015.1140ANO.002.84	4000K / 5050Lm / 45W	1140mm	Antr./Dark Grey	P.U. 185,00	015.2540ANO.002.84	4000K / 11350Lm / 100W	2540mm	Antr./Dark Grey	P.U. 370,00
015.1140WO.002.54	5700K / 5200Lm / 45W	1140mm	BR/White	P.U. 185,00	015.2540WO.002.54	5700K / 11700Lm / 100W	2540mm	BR/White	P.U. 370,00
015.1140ACO.002.54	5700K / 5200Lm / 45W	1140mm	Acet. Nat./ Nat. Satin	P.U. 185,00	015.2540ACO.002.54	5700K / 11700Lm / 100W	2540mm	Acet. Nat./Anodized	P.U. 370,00
015.1140ANO.002.54	5700K / 5200Lm / 45W	1140mm	Antr./Dark Grey	P.U. 185,00	015.2540ANO.002.54	5700K / 11700Lm / 100W	2540mm	Antr./Dark Grey	P.U. 370,00
015.1420WO.002.82	2700K / 6100Lm / 55W	1420mm	BR/White	P.U. 200,00	015.2820WO.002.82	2700K / 12200Lm / 110W	2820mm	BR/White	P.U. 390,00
015.1420ACO.002.82	2700K / 6100Lm / 55W	1420mm	Acet. Nat./ Nat. Satin	P.U. 200,00	015.2820ACO.002.82	2700K / 12200Lm / 110W	2820mm	Acet. Nat./Anodized	P.U. 390,00
015.1420ANO.002.82	2700K / 6100Lm / 55W	1420mm	Antr./Dark Grey	P.U. 200,00	015.2820ANO.002.82	2700K / 12200Lm / 110W	2820mm	Antr./Dark Grey	P.U. 390,00
015.1420WO.002.84	4000K / 6300Lm / 55W	1420mm	BR/White	P.U. 200,00	015.2820WO.002.84	4000K / 12600Lm / 110W	2820mm	BR/White	P.U. 390,00
015.1420ACO.002.84	4000K / 6300Lm / 55W	1420mm	Acet. Nat./ Nat. Satin	P.U. 200,00	015.2820ACO.002.84	4000K / 12600Lm / 110W	2820mm	Acet. Nat./Anodized	P.U. 390,00
015.1420ANO.002.84	4000K / 6300Lm / 55W	1420mm	Antr./Dark Grey	P.U. 200,00	015.2820ANO.002.84	4000K / 12600Lm / 110W	2820mm	Antr./Dark Grey	P.U. 390,00
015.1420WO.002.54	5700K / 6500Lm / 55W	1420mm	BR/White	P.U. 200,00	015.2820WO.002.54	5700K / 13050Lm / 110W	2820mm	BR/White	P.U. 390,00
015.1420ACO.002.54	5700K / 6500Lm / 55W	1420mm	Acet. Nat./Anodized	P.U. 200,00	015.2820ACO.002.54	5700K / 13050Lm / 110W	2820mm	Acet. Nat./Anodized	P.U. 390,00
015.1420ANO.002.54	5700K / 6500Lm / 55W	1420mm	Antr./Dark Grey	P.U. 200,00	015.2820ANO.002.54	5700K / 13050Lm / 110W	2820mm	Antr./Dark Grey	P.U. 390,00
015.1700WO.002.82	2700K / 7300Lm / 65W	1700mm	BR/White	P.U. 225,00					
015.1700ACO.002.82	2700K / 7300Lm / 65W	1700mm	Acet. Nat./ Nat. Satin	P.U. 225,00					
015.1700ANO.002.82	2700K / 7300Lm / 65W	1700mm	Antr./Dark Grey	P.U. 225,00					
015.1700WO.002.84	4000K / 6760Lm / 65W	1700mm	BR/White	P.U. 225,00					
015.1700ACO.002.84	4000K / 7600Lm / 65W	1700mm	Acet. Nat./ Nat. Satin	P.U. 225,00					
015.1700ANO.002.84	4000K / 7600Lm / 65W	1700mm	Antr./Dark Grey	P.U. 225,00					
015.1700WO.002.54	5700K / 7850Lm / 65W	1700mm	BR/White	P.U. 225,00					
015.1700ACO.002.54	5700K / 7850Lm / 65W	1700mm	Acet. Nat./Anodized	P.U. 225,00					
015.1700ANO.002.54	5700K / 7850Lm / 65W	1700mm	Antr./Dark Grey	P.U. 225,00					

Opções por Encomenda: Dimensões Específicas (mínimo 56mm) - Kit de Emergência - DALI - Dimável - Sistema de controle de Iluminação (lux contol)

Obs: Não ligar com Sensores

Devido à constante evolução deste tipo de produtos a marca dos Led's e Drivers assim como as características técnicas podem ser alterados sem aviso prévio, por favor consultar o folheto ou solicitar a ficha técnica actualizada dos artigos pretendidos.

Luminária em Alumínio Extrudido c/ Barra Led e Driver
Extruded Aluminium Equipped with Led PCB and Driver

Led: **OSRAM**

Driver: **AMW** ou / or **TRIDONIC**

Placa Led 50 000 Horas; 5 Anos Garantia

Led PCB 50 000 Hours; 5 Years Warranty



Electrificado com barra Led (Osram) Simples (1 Linha)
Assembled with Osram Led (1 Led Line)

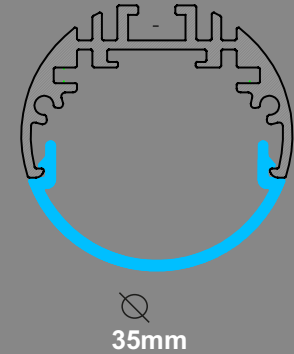

Olivais 35

C'ódigo/Code	Led / Lm / W	L	Cor/Color	€	Código/Code	Led / Lm / W	L	Cor/Color	€
016.0580WO.001.82	2700K / 1220Lm / 15W	580mm	BR/White	P.U. 125,00	016.1980WO.001.82	2700K / 4300Lm / 40W	1980mm	BR/White	P.U. 220,00
016.0580ACO.001.82	2700K / 1220Lm / 15W	580mm	Acet. Nat./ Nat.Satin	P.U. 125,00	016.1980ACO.001.82	2700K / 4300Lm / 40W	1980mm	Acet. Nat./Anodized	P.U. 220,00
016.0580ANO.001.82	2700K / 1220Lm / 15W	580mm	Antr./Dark Grey	P.U. 125,00	016.1980ANO.001.82	2700K / 4300Lm / 40W	1980mm	Antr./Dark Grey	P.U. 220,00
016.0580WO.001.84	4000K / 1300Lm / 15W	580mm	BR/White	P.U. 125,00	016.1980WO.001.84	4000K / 4450Lm / 40W	1980mm	BR/White	P.U. 220,00
016.0580ACO.001.84	4000K / 1300Lm / 15W	580mm	Acet. Nat./ Nat.Satin	P.U. 125,00	016.1980ACO.001.84	4000K / 4450Lm / 40W	1980mm	Acet. Nat./Anodized	P.U. 220,00
016.0580ANO.001.84	4000K / 1300Lm / 15W	580mm	Antr./Dark Grey	P.U. 125,00	016.1980ANO.001.84	4000K / 4450Lm / 40W	1980mm	Antr./Dark Grey	P.U. 220,00
016.0580WO.001.54	5700K / 1350Lm / 15W	580mm	BR/White	P.U. 125,00	016.1980WO.001.54	5700K / 4550Lm / 40W	1980mm	BR/White	P.U. 220,00
016.0580ACO.001.54	5700K / 1350Lm / 15W	580mm	Acet. Nat./ Nat.Satin	P.U. 125,00	016.1980ACO.001.54	5700K / 4550Lm / 40W	1980mm	Acet. Nat./Anodized	P.U. 220,00
016.0580ANO.001.54	5700K / 1350Lm / 15W	580mm	Antr./Dark Grey	P.U. 125,00	016.1980ANO.001.54	5700K / 4550Lm / 40W	1980mm	Antr./Dark Grey	P.U. 220,00
016.0860WO.001.82	2700K / 1850Lm / 20W	860mm	BR/White	P.U. 140,00	016.2260WO.001.82	2700K / 4900Lm / 45W	2260mm	BR/White	P.U. 240,00
016.0860ACO.001.82	2700K / 1850Lm / 20W	860mm	Acet. Nat./ Nat.Satin	P.U. 140,00	016.2260ACO.001.82	2700K / 4900Lm / 45W	2260mm	Acet. Nat./Anodized	P.U. 240,00
016.0860ANO.001.82	2700K / 1850Lm / 20W	860mm	Antr./Dark Grey	P.U. 140,00	016.2260ANO.001.82	2700K / 4900Lm / 45W	2260mm	Antr./Dark Grey	P.U. 240,00
016.0860WO.001.84	4000K / 1900Lm / 20W	860mm	BR/White	P.U. 140,00	016.2260WO.001.84	4000K / 5050Lm / 45W	2260mm	BR/White	P.U. 240,00
016.0860ACO.001.84	4000K / 1900Lm / 20W	860mm	Acet. Nat./ Nat.Satin	P.U. 140,00	016.2260ACO.001.84	4000K / 5050Lm / 45W	2260mm	Acet. Nat./Anodized	P.U. 240,00
016.0860ANO.001.84	4000K / 1900Lm / 20W	860mm	Antr./Dark Grey	P.U. 140,00	016.2260ANO.001.84	4000K / 5050Lm / 45W	2260mm	Antr./Dark Grey	P.U. 240,00
016.0860WO.001.54	5700K / 1950Lm / 20W	860mm	BR/White	P.U. 140,00	016.2260WO.001.54	5700K / 5200Lm / 45W	2260mm	BR/White	P.U. 240,00
016.0860ACO.001.54	5700K / 1950Lm / 20W	860mm	Acet. Nat./ Nat.Satin	P.U. 140,00	016.2260ACO.001.54	5700K / 5200Lm / 45W	2260mm	Acet. Nat./Anodized	P.U. 240,00
016.0860ANO.001.54	5700K / 1950Lm / 20W	860mm	Antr./Dark Grey	P.U. 140,00	016.2260ANO.001.54	5700K / 5200Lm / 45W	2260mm	Antr./Dark Grey	P.U. 240,00
016.1140WO.001.82	2700K / 2450Lm / 25W	1140mm	BR/White	P.U. 170,00	016.2540WO.001.82	2700K / 5500Lm / 50W	2540mm	BR/White	P.U. 250,00
016.1140ACO.001.82	2700K / 2450Lm / 25W	1140mm	Acet. Nat./ Nat. Satin	P.U. 170,00	016.2540ACO.001.82	2700K / 5500Lm / 50W	2540mm	Acet. Nat./Anodized	P.U. 250,00
016.1140ANO.001.82	2700K / 2450Lm / 25W	1140mm	Antr./Dark Grey	P.U. 170,00	016.2540ANO.001.82	2700K / 5500Lm / 50W	2540mm	Antr./Dark Grey	P.U. 250,00
016.1140WO.001.84	4000K / 2550Lm / 25W	1140mm	BR/White	P.U. 170,00	016.2540WO.001.84	4000K / 5700Lm / 50W	2540mm	BR/White	P.U. 250,00
016.1140ACO.001.84	4000K / 2550Lm / 25W	1140mm	Acet. Nat./ Nat.Satin	P.U. 170,00	016.2540ACO.001.84	4000K / 5700Lm / 50W	2540mm	Acet. Nat./Anodized	P.U. 250,00
016.1140ANO.001.84	4000K / 2550Lm / 25W	1140mm	Antr./Dark Grey	P.U. 170,00	016.2540ANO.001.84	4000K / 5700Lm / 50W	2540mm	Antr./Dark Grey	P.U. 250,00
016.1140WO.0001.54	5700K / 2650Lm / 25W	1140mm	BR/White	P.U. 170,00	016.2540WO.001.54	5700K / 5900Lm / 50W	2540mm	BR/White	P.U. 250,00
016.1140ACO.001.54	5700K / 2650Lm / 25W	1140mm	Acet. Nat./ Nat. Satin	P.U. 170,00	016.2540ACO.001.54	5700K / 5900Lm / 50W	2540mm	Acet. Nat./Anodized	P.U. 250,00
016.1140ANO.001.54	5700K / 2650Lm / 25W	1140mm	Antr./Dark Grey	P.U. 170,00	016.2540ANO.001.54	5700K / 5900Lm / 50W	2540mm	Antr./Dark Grey	P.U. 250,00
016.1420WO.001.82	2700K / 3050Lm / 30W	1420mm	BR/White	P.U. 184,00	016.2820WO.001.82	2700K / 6100Lm / 55W	2820mm	BR/White	P.U. 280,00
016.1420ACO.001.82	2700K / 3050Lm / 30W	1420mm	Acet. Nat./ Nat. Satin	P.U. 184,00	016.2820ACO.001.82	2700K / 6100Lm / 55W	2820mm	Acet. Nat./Anodized	P.U. 280,00
016.1420ANO.001.82	2700K / 3050Lm / 30W	1420mm	Antr./Dark Grey	P.U. 184,00	016.2820ANO.001.82	2700K / 6100Lm / 55W	2820mm	Antr./Dark Grey	P.U. 280,00
016.1420WO.001.84	4000K / 3150Lm / 30W	1420mm	BR/White	P.U. 184,00	016.2820WO.001.84	4000K / 6300Lm / 55W	2820mm	BR/White	P.U. 280,00
016.1420ACO.001.84	4000K / 3150Lm / 30W	1420mm	Acet. Nat./ Nat. Satin	P.U. 184,00	016.2820ACO.001.84	4000K / 6300Lm / 55W	2820mm	Acet. Nat./Anodized	P.U. 280,00
016.1420ANO.001.84	4000K / 3150Lm / 30W	1420mm	Antr./Dark Grey	P.U. 184,00	016.2820ANO.001.84	4000K / 6300Lm / 55W	2820mm	Antr./Dark Grey	P.U. 280,00
016.1420WO.001.54	5700K / 3250Lm / 30W	1420mm	BR/White	P.U. 184,00	016.2820WO.001.54	5700K / 6500Lm / 55W	2820mm	BR/White	P.U. 280,00
016.1420ACO.001.54	5700K / 3250Lm / 30W	1420mm	Acet. Nat./Anodized	P.U. 184,00	016.2820ACO.001.54	5700K / 6500Lm / 55W	2820mm	Acet. Nat./Anodized	P.U. 280,00
016.1420ANO.001.54	5700K / 3250Lm / 30W	1420mm	Antr./Dark Grey	P.U. 184,00	016.2820ANO.001.54	5700K / 6500Lm / 55W	2820mm	Antr./Dark Grey	P.U. 280,00
016.1700WO.001.82	2700K / 3700Lm / 35W	1700mm	BR/White	P.U. 205,00					
016.1700ACO.001.82	2700K / 3700Lm / 35W	1700mm	Acet. Nat./Anodized	P.U. 205,00					
016.1700ANO.001.82	2700K / 3700Lm / 35W	1700mm	Antr./Dark Grey	P.U. 205,00					
016.1700WO.001.84	4000K / 3800Lm / 35W	1700mm	BR/White	P.U. 205,00					
016.1700ACO.001.84	4000K / 3800Lm / 35W	1700mm	Acet. Nat./Anodized	P.U. 205,00					
016.1700ANO.001.84	4000K / 3800Lm / 35W	1700mm	Antr./Dark Grey	P.U. 205,00					
016.1700WO.001.54	5700K / 3900Lm / 35W	1700mm	BR/White	P.U. 205,00					
016.1700ACO.001.54	5700K / 3900Lm / 35W	1700mm	Acet. Nat./Anodized	P.U. 205,00					
016.1700ANO.001.54	5700K / 3900Lm / 35W	1700mm	Antr./Dark Grey	P.U. 205,00					

Opções por Encomenda: Dimensões Específicas (mínimo 56mm) - Kit de Emergência - DALI - Dimável - Sistema de controle de Iluminação (lux contol)

Obs: Não ligar com Sensores

Divulgo e constatare evolução de este tipo de produtos a marca dos Led e Drivers assim como as características técnicas podem ser alterados sem aviso prévio, por favor consultar o folheto ou isolado a ficha técnica actualizada dos artigos pretendidos

Olivais 60

soflight®



Luminária em Alumínio Extrudido c/ Barra Led e Driver
Extruded Aluminium Equipped with Led PCB and Driver

Led: **OSRAM**

Driver: **MW** ou / or **TRIDONIC**

Placa Led 50 000 Horas; 5 Anos Garantia

Led PCB 50 000 Hours; 5 Years Warranty



Electrificado com barra Led (Osram) Simples (1 Linha)
Assembled with Osram Led (1 Led Line)

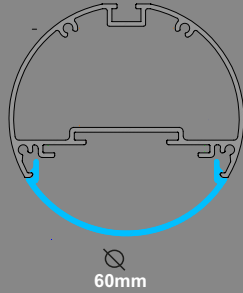

Olivais 60

Código/Code	Led / Lm / W	L	Cor/Color	€	Código/Code	Led / Lm / W	L	Cor/Color	€
017.0580WO.001.82	2700K / 1220Lm / 15W	580mm	BR/White	P.U. 134,00	017.1980WO.001.82	2700K / 4300Lm / 40W	1980mm	BR/White	P.U. 244,00
017.0580ACO.001.82	2700K / 1220Lm / 15W	580mm	Acet. Nat./ Nat.Satin	P.U. 134,00	017.1980ACO.001.82	2700K / 4300Lm / 40W	1980mm	Acet. Nat./Anodized	P.U. 244,00
017.0580ANO.001.82	2700K / 1220Lm / 15W	580mm	Antr./Dark Grey	P.U. 134,00	017.1980ANO.001.82	2700K / 4300Lm / 40W	1980mm	Antr./Dark Grey	P.U. 244,00
017.0580WO.001.84	4000K / 1300Lm / 15W	580mm	BR/White	P.U. 134,00	017.1980WO.001.84	4000K / 4450Lm / 40W	1980mm	BR/White	P.U. 244,00
017.0580ACO.001.84	4000K / 1300Lm / 15W	580mm	Acet. Nat./ Nat.Satin	P.U. 134,00	017.1980ACO.001.84	4000K / 4450Lm / 40W	1980mm	Acet. Nat./Anodized	P.U. 244,00
017.0580ANO.001.84	4000K / 1300Lm / 15W	580mm	Antr./Dark Grey	P.U. 134,00	017.1980ANO.001.84	4000K / 4450Lm / 40W	1980mm	Antr./Dark Grey	P.U. 244,00
017.0580WO.001.54	5700K / 1350Lm / 15W	580mm	BR/White	P.U. 134,00	017.1980WO.001.54	5700K / 4550Lm / 40W	1980mm	BR/White	P.U. 244,00
017.0580ACO.001.54	5700K / 1350Lm / 15W	580mm	Acet. Nat./ Nat.Satin	P.U. 134,00	017.1980ACO.001.54	5700K / 4550Lm / 40W	1980mm	Acet. Nat./Anodized	P.U. 244,00
017.0580ANO.001.54	5700K / 1350Lm / 15W	580mm	Antr./Dark Grey	P.U. 134,00	017.1980ANO.001.54	5700K / 4550Lm / 40W	1980mm	Antr./Dark Grey	P.U. 244,00
017.0860WO.001.82	2700K / 1850Lm / 20W	860mm	BR/White	P.U. 151,00	017.2260WO.001.82	2700K / 4900Lm / 45W	2260mm	BR/White	P.U. 270,00
017.0860ACO.001.82	2700K / 1850Lm / 20W	860mm	Acet. Nat./ Nat.Satin	P.U. 151,00	017.2260ACO.001.82	2700K / 4900Lm / 45W	2260mm	Acet. Nat./Anodized	P.U. 270,00
017.0860ANO.001.82	2700K / 1850Lm / 20W	860mm	Antr./Dark Grey	P.U. 151,00	017.2260ANO.001.82	2700K / 4900Lm / 45W	2260mm	Antr./Dark Grey	P.U. 270,00
017.0860WO.001.84	4000K / 1900Lm / 20W	860mm	BR/White	P.U. 151,00	017.2260WO.001.84	4000K / 5050Lm / 45W	2260mm	BR/White	P.U. 270,00
017.0860ACO.001.84	4000K / 1900Lm / 20W	860mm	Acet. Nat./ Nat.Satin	P.U. 151,00	017.2260ACO.001.84	4000K / 5050Lm / 45W	2260mm	Acet. Nat./Anodized	P.U. 270,00
017.0860ANO.001.84	4000K / 1900Lm / 20W	860mm	Antr./Dark Grey	P.U. 151,00	017.2260ANO.001.84	4000K / 5050Lm / 45W	2260mm	Antr./Dark Grey	P.U. 270,00
017.0860WO.001.54	5700K / 1950Lm / 20W	860mm	BR/White	P.U. 151,00	017.2260WO.001.54	5700K / 5200Lm / 45W	2260mm	BR/White	P.U. 270,00
017.0860ACO.001.54	5700K / 1950Lm / 20W	860mm	Acet. Nat./ Nat.Satin	P.U. 151,00	017.2260ACO.001.54	5700K / 5200Lm / 45W	2260mm	Acet. Nat./Anodized	P.U. 270,00
017.0860ANO.001.54	5700K / 1950Lm / 20W	860mm	Antr./Dark Grey	P.U. 151,00	017.2260ANO.001.54	5700K / 5200Lm / 45W	2260mm	Antr./Dark Grey	P.U. 270,00
017.1140WO.001.82	2700K / 2450Lm / 25W	1140mm	BR/White	P.U. 185,00	017.2540WO.001.82	2700K / 5500Lm / 50W	2540mm	BR/White	P.U. 280,00
017.1140ACO.001.82	2700K / 2450Lm / 25W	1140mm	Acet. Nat./ Nat. Satin	P.U. 185,00	017.2540ACO.001.82	2700K / 5500Lm / 50W	2540mm	Acet. Nat./Anodized	P.U. 280,00
017.1140ANO.001.82	2700K / 2450Lm / 25W	1140mm	Antr./Dark Grey	P.U. 185,00	017.2540ANO.001.82	2700K / 5500Lm / 50W	2540mm	Antr./Dark Grey	P.U. 280,00
017.1140WO.001.84	4000K / 2550Lm / 25W	1140mm	BR/White	P.U. 185,00	017.2540WO.001.84	4000K / 5500Lm / 50W	2540mm	BR/White	P.U. 280,00
017.1140ACO.001.84	4000K / 2550Lm / 25W	1140mm	Acet. Nat./ Nat.Satin	P.U. 185,00	017.2540ACO.001.84	4000K / 5500Lm / 50W	2540mm	Acet. Nat./Anodized	P.U. 280,00
017.1140ANO.001.84	4000K / 2550Lm / 25W	1140mm	Antr./Dark Grey	P.U. 185,00	017.2540ANO.001.84	4000K / 5500Lm / 50W	2540mm	Antr./Dark Grey	P.U. 280,00
017.1140WO.001.54	5700K / 2650Lm / 25W	1140mm	BR/White	P.U. 185,00	017.2540WO.001.54	5700K / 5500Lm / 50W	2540mm	BR/White	P.U. 280,00
017.1140ACO.001.54	5700K / 2650Lm / 25W	1140mm	Acet. Nat./ Nat. Satin	P.U. 185,00	017.2540ACO.001.54	5700K / 5500Lm / 50W	2540mm	Acet. Nat./Anodized	P.U. 280,00
017.1140ANO.001.54	5700K / 2650Lm / 25W	1140mm	Antr./Dark Grey	P.U. 185,00	017.2540ANO.001.54	5700K / 5500Lm / 50W	2540mm	Antr./Dark Grey	P.U. 280,00
017.1420WO.001.82	2700K / 3050Lm / 30W	1420mm	BR/White	P.U. 202,00	017.2820WO.001.82	2700K / 6100Lm / 55W	2820mm	BR/White	P.U. 310,00
017.1420ACO.001.82	2700K / 3750Lm / 30W	1420mm	Acet. Nat./ Nat. Satin	P.U. 202,00	017.2820ACO.001.82	2700K / 6100Lm / 55W	2820mm	Acet. Nat./Anodized	P.U. 310,00
017.1420ANO.001.82	2700K / 3050Lm / 30W	1420mm	Antr./Dark Grey	P.U. 202,00	017.2820ANO.001.82	2700K / 6100Lm / 55W	2820mm	Antr./Dark Grey	P.U. 310,00
017.1420WO.001.84	4000K / 3150Lm / 30W	1420mm	BR/White	P.U. 202,00	017.2820WO.001.84	4000K / 6300Lm / 55W	2820mm	BR/White	P.U. 310,00
017.1420ACO.001.84	4000K / 3150Lm / 30W	1420mm	Acet. Nat./ Nat. Satin	P.U. 202,00	017.2820ACO.001.84	4000K / 6300Lm / 55W	2820mm	Acet. Nat./Anodized	P.U. 310,00
017.1420ANO.001.84	4000K / 3150Lm / 30W	1420mm	Antr./Dark Grey	P.U. 202,00	017.2820ANO.001.84	4000K / 6300Lm / 55W	2820mm	Antr./Dark Grey	P.U. 310,00
017.1420WO.001.54	5700K / 3250Lm / 30W	1420mm	BR/White	P.U. 202,00	017.2820WO.001.54	5700K / 6500Lm / 55W	2820mm	BR/White	P.U. 310,00
017.1420ACO.001.54	5700K / 3250Lm / 30W	1420mm	Acet. Nat./Anodized	P.U. 202,00	017.2820ACO.001.54	5700K / 6500Lm / 55W	2820mm	Acet. Nat./Anodized	P.U. 310,00
017.1420ANO.001.54	5700K / 3250Lm / 30W	1420mm	Antr./Dark Grey	P.U. 202,00	017.2820ANO.001.54	5700K / 6500Lm / 55W	2820mm	Antr./Dark Grey	P.U. 310,00
017.1700WO.001.82	2700K / 3700Lm / 35W	1700mm	BR/White	P.U. 230,00					
017.1700ACO.001.82	2700K / 3700Lm / 35W	1700mm	Acet. Nat./ Nat. Satin	P.U. 230,00					
017.1700ANO.001.82	2700K / 3700Lm / 35W	1700mm	Antr./Dark Grey	P.U. 230,00					
017.1700WO.001.84	4000K / 3800Lm / 35W	1700mm	BR/White	P.U. 230,00					
017.1700ACO.001.84	4000K / 3800Lm / 35W	1700mm	Acet. Nat./ Nat. Satin	P.U. 230,00					
017.1700ANO.001.84	4000K / 3800Lm / 35W	1700mm	Antr./Dark Grey	P.U. 230,00					
017.1700WO.001.54	5700K / 3900Lm / 35W	1700mm	BR/White	P.U. 230,00					
017.1700ACO.001.54	5700K / 3900Lm / 35W	1700mm	Acet. Nat./Anodized	P.U. 230,00					
017.1700ANO.001.54	5700K / 3900Lm / 35W	1700mm	Antr./Dark Grey	P.U. 230,00					

Opções por Encomenda: Dimensões Específicas (mínimo 56mm) - Kit de Emergência - DALI - Dimável - Sistema de controle de iluminação (lux contol)

Obs: Não ligar com Sensores

Devido à constante evolução desta tipo de produtos a marca dos Led's e Drivers assim como as características técnicas podem ser alterados sem aviso prévio, por favor consultar o folheto ou site na ficha técnica actualizada dos artigos pretendidos.



Luminária em Alumínio Extrudido c/ Barra Led e Driver
Extruded Aluminium Equipped with Led PCB and Driver



Led: **OSRAM**

Driver: **MW** ou / or **TRIDONIC**

Electrificado com barra Led (**Osram**) Dupla (2 Linhas)
Assembled with **Osram** Led (2 Led Line)

Placa Led 50 000 Horas; 5 Anos Garantia

Led PCB 50 000 Hours; 5 Years Warranty

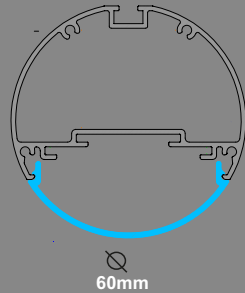

Olivais 60

Código/Code	Led / Lm / W	L	Cor/Color	€	Código/Code	Led / Lm / W	L	Cor/Color	€
017.0580WO.002.82	2700K / 2450Lm / 25W	580mm	BR/White	P.U. 150,00	017.1980WO.002.82	2700K / 8550Lm / 75W	1980mm	BR/White	P.U. 350,00
017.0580ACO.002.82	2700K / 2450Lm / 25W	580mm	Acet. Nat./ Nat.Satin	P.U. 150,00	017.1980ACO.002.82	2700K / 8550Lm / 75W	1980mm	Acet. Nat./Anodized	P.U. 350,00
017.0580ANO.002.82	2700K / 2450Lm / 25W	580mm	Antr./Dark Grey	P.U. 150,00	017.1980ANO.002.82	2700K / 8550Lm / 75W	1980mm	Antr./Dark Grey	P.U. 350,00
017.0580WO.002.84	4000K / 2550Lm / 25W	580mm	BR/White	P.U. 150,00	017.1980WO.002.84	4000K / 8850Lm / 75W	1980mm	BR/White	P.U. 350,00
017.0580ACO.002.84	4000K / 2550Lm / 25W	580mm	Acet. Nat./ Nat.Satin	P.U. 150,00	017.1980ACO.002.84	4000K / 8850Lm / 75W	1980mm	Acet. Nat./Anodized	P.U. 350,00
017.0580ANO.002.84	4000K / 2550Lm / 25W	580mm	Antr./Dark Grey	P.U. 150,00	017.1980ANO.002.84	4000K / 8850Lm / 75W	1980mm	Antr./Dark Grey	P.U. 350,00
017.0580WO.002.54	5700K / 2620Lm / 25W	580mm	BR/White	P.U. 150,00	017.1980WO.002.54	5700K / 9150Lm / 75W	1980mm	BR/White	P.U. 350,00
017.0580ACO.002.54	5700K / 2620Lm / 25W	580mm	Acet. Nat./ Nat.Satin	P.U. 150,00	017.1980ACO.002.54	5700K / 9150Lm / 75W	1980mm	Acet. Nat./Anodized	P.U. 350,00
017.0580ANO.002.54	5700K / 2620Lm / 25W	580mm	Antr./Dark Grey	P.U. 150,00	010.1980ANO.002.54	5700K / 5910Lm / 75W	1980mm	Antr./Dark Grey	P.U. 350,00
017.0860WO.002.82	2700K / 3700Lm / 35W	860mm	BR/White	P.U. 175,00	017.2260WO.002.82	2700K / 9750Lm / 90W	2260mm	BR/White	P.U. 380,00
017.0860ACO.002.82	2700K / 3700Lm / 35W	860mm	Acet. Nat./ Nat.Satin	P.U. 175,00	017.2260ACO.002.82	2700K / 9750Lm / 90W	2260mm	Acet. Nat./Anodized	P.U. 380,00
017.0860ANO.002.82	2700K / 3700Lm / 35W	860mm	Antr./Dark Grey	P.U. 175,00	017.2260ANO.002.82	2700K / 9750Lm / 90W	2260mm	Antr./Dark Grey	P.U. 380,00
017.0860WO.002.84	4000K / 3800Lm / 35W	860mm	BR/White	P.U. 175,00	017.2260WO.002.84	4000K / 10100Lm / 90W	2260mm	BR/White	P.U. 380,00
017.0860ACO.002.84	4000K / 3800Lm / 35W	860mm	Acet. Nat./ Nat.Satin	P.U. 175,00	017.2260ACO.002.84	4000K / 10100Lm / 90W	2260mm	Acet. Nat./Anodized	P.U. 380,00
017.0860ANO.002.84	4000K / 3800Lm / 35W	860mm	Antr./Dark Grey	P.U. 175,00	017.2260ANO.002.84	4000K / 10100Lm / 90W	2260mm	Antr./Dark Grey	P.U. 380,00
017.0860WO.002.54	5700K / 3900Lm / 35W	860mm	BR/White	P.U. 175,00	017.2260WO.002.54	5700K / 10400Lm / 90W	2260mm	BR/White	P.U. 380,00
017.0860ACO.002.54	5700K / 3900Lm / 35W	860mm	Acet. Nat./ Nat.Satin	P.U. 175,00	017.2260ACO.002.54	5700K / 10400Lm / 90W	2260mm	Acet. Nat./Anodized	P.U. 380,00
017.0860ANO.002.54	5700K / 3900Lm / 35W	860mm	Antr./Dark Grey	P.U. 175,00	017.2260ANO.002.54	5700K / 10400Lm / 90W	2260mm	Antr./Dark Grey	P.U. 380,00
017.1140WO.002.82	2700K / 4900Lm / 45W	1140mm	BR/White	P.U. 200,00	017.2540WO.002.82	2700K / 11000Lm / 100W	2540mm	BR/White	P.U. 403,00
017.1140ACO.002.82	2700K / 4900Lm / 45W	1140mm	Acet. Nat./ Nat. Satin	P.U. 200,00	017.2540ACO.002.82	2700K / 11000Lm / 100W	2540mm	Acet. Nat./Anodized	P.U. 403,00
017.1140ANO.002.82	2700K / 4900Lm / 45W	1140mm	Antr./Dark Grey	P.U. 200,00	017.2540ANO.002.82	2700K / 11000Lm / 100W	2540mm	Antr./Dark Grey	P.U. 403,00
017.1140WO.002.84	4000K / 5050Lm / 45W	1140mm	BR/White	P.U. 200,00	017.2540WO.002.84	4000K / 11350Lm / 100W	2540mm	BR/White	P.U. 403,00
017.1140ACO.002.84	4000K / 5050Lm / 45W	1140mm	Acet. Nat./ Nat.Satin	P.U. 200,00	017.2540ACO.002.84	4000K / 11350Lm / 100W	2540mm	Acet. Nat./Anodized	P.U. 403,00
017.1140ANO.002.84	4000K / 5050Lm / 45W	1140mm	Antr./Dark Grey	P.U. 200,00	017.2540ANO.002.84	4000K / 11350Lm / 100W	2540mm	Antr./Dark Grey	P.U. 403,00
017.1140WO.002.54	5700K / 5200Lm / 45W	1140mm	BR/White	P.U. 200,00	017.2540WO.002.54	5700K / 11700Lm / 100W	2540mm	BR/White	P.U. 403,00
017.1140ACO.002.54	5700K / 5200Lm / 45W	1140mm	Acet. Nat./ Nat. Satin	P.U. 200,00	017.2540ACO.002.54	5700K / 11700Lm / 100W	2540mm	Acet. Nat./Anodized	P.U. 403,00
017.1140ANO.002.54	5700K / 5200Lm / 45W	1140mm	Antr./Dark Grey	P.U. 200,00	017.2540ANO.002.54	5700K / 11700Lm / 100W	2540mm	Antr./Dark Grey	P.U. 403,00
017.1420WO.002.82	2700K / 6100Lm / 55W	1420mm	BR/White	P.U. 220,00	017.2820WO.002.82	2700K / 12200Lm / 110W	2820mm	BR/White	P.U. 425,00
017.1420ACO.002.82	2700K / 6100Lm / 55W	1420mm	Acet. Nat./ Nat. Satin	P.U. 220,00	017.2820ACO.002.82	2700K / 12200Lm / 110W	2820mm	Acet. Nat./Anodized	P.U. 425,00
017.1420ANO.002.82	2700K / 6100Lm / 55W	1420mm	Antr./Dark Grey	P.U. 220,00	017.2820ANO.002.82	2700K / 12200Lm / 110W	2820mm	Antr./Dark Grey	P.U. 425,00
017.1420WO.002.84	4000K / 6300Lm / 55W	1420mm	BR/White	P.U. 220,00	017.2820WO.002.84	4000K / 12600Lm / 110W	2820mm	BR/White	P.U. 425,00
017.1420ACO.002.84	4000K / 6300Lm / 55W	1420mm	Acet. Nat./ Nat. Satin	P.U. 220,00	017.2820ACO.002.84	4000K / 12600Lm / 110W	2820mm	Acet. Nat./Anodized	P.U. 425,00
017.1420ANO.002.84	4000K / 6300Lm / 55W	1420mm	Antr./Dark Grey	P.U. 220,00	017.2820ANO.002.84	4000K / 12600Lm / 110W	2820mm	Antr./Dark Grey	P.U. 425,00
017.1420WO.002.54	5700K / 6500Lm / 55W	1420mm	BR/White	P.U. 220,00	017.2820WO.002.54	5700K / 13050Lm / 110W	2820mm	BR/White	P.U. 425,00
017.1420ACO.002.54	5700K / 6500Lm / 55W	1420mm	Acet. Nat./Anodized	P.U. 220,00	017.2820ACO.002.54	5700K / 13050Lm / 110W	2820mm	Acet. Nat./Anodized	P.U. 425,00
017.1420ANO.002.54	5700K / 6500Lm / 55W	1420mm	Antr./Dark Grey	P.U. 220,00	017.2820ANO.002.54	5700K / 13050Lm / 110W	2820mm	Antr./Dark Grey	P.U. 425,00
017.1700WO.002.82	2700K / 7300Lm / 65W	1700mm	BR/White	P.U. 240,00					
017.1700ACO.002.82	2700K / 7300Lm / 65W	1700mm	Acet. Nat./ Nat. Satin	P.U. 240,00					
017.1700ANO.002.82	2700K / 7300Lm / 65W	1700mm	Antr./Dark Grey	P.U. 240,00					
017.1700WO.002.84	4000K / 7600Lm / 65W	1700mm	BR/White	P.U. 240,00					
017.1700ACO.002.84	4000K / 7600Lm / 65W	1700mm	Acet. Nat./ Nat. Satin	P.U. 240,00					
017.1700ANO.002.84	4000K / 7600Lm / 65W	1700mm	Antr./Dark Grey	P.U. 240,00					
017.1700WO.002.54	5700K / 7580Lm / 65W	1700mm	BR/White	P.U. 240,00					
017.1700ACO.002.54	5700K / 7850Lm / 65W	1700mm	Acet. Nat./Anodized	P.U. 240,00					
017.1700ANO.002.54	5700K / 7850Lm / 65W	1700mm	Antr./Dark Grey	P.U. 240,00					

Opções por Encomenda: Dimensões Específicas (mínimo 56mm) - Kit de Emergência - DALI - Dimável - Sistema de controle de Iluminação (lux contol)

Obs: Não ligar com Sensores

Devido à constante evolução deste tipo de produtos a marca dos Led's e Drivers assim como as características técnicas podem ser alterados sem aviso prévio, por favor consultar o folheto ou solicitar a ficha técnica actualizada dos artigos pretendidos.

Luminária em Alumínio Extrudido c/ Barra Led e Driver
Extruded Aluminium Equipped with Led PCB and Driver

Led: **OSRAM**

Driver: ou / or

Placa Led 50 000 Horas; 5 Anos Garantia

Led PCB 50 000 Hours; 5 Years Warranty

Electrificado com 2 fitas Led
Assembled with 2 Led Strip



Oriente 102

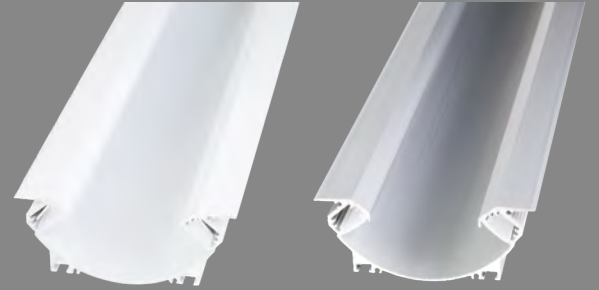
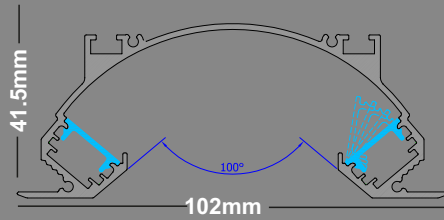

Código/Code	Led / Lm / W	L	Cor/Color	€	Código/Code	Led / Lm / W	L	Cor/Color	€
019.0520WO.003.82	2700K / 1500Lm / 11W	520mm	BR/White	P.U. 195,00	019.1020WO.003.82	2700K / 3000Lm / 21W	1020mm	BR/White	P.U. 266,00
019.0520ACO.003.82	2700K / 1500Lm / 11W	520mm	Acet. Nat./ Nat.Satin	P.U. 195,00	019.1020ACO.003.82	2700K / 3000Lm / 21W	1020mm	Acet. Nat./Anodized	P.U. 266,00
019.0520WO.003.84	4000K / 1500Lm / 11W	520mm	BR/White	P.U. 195,00	019.1020WO.003.84	4000K / 3000Lm / 21W	1020mm	BR/White	P.U. 266,00
019.0520ACO.003.84	4000K / 1500Lm / 11W	520mm	Acet. Nat./ Nat.Satin	P.U. 195,00	019.1020ACO.003.84	4000K / 3000Lm / 21W	1020mm	Acet. Nat./Anodized	P.U. 266,00
019.0520WO.003.54	5700K / 1500Lm / 11W	520mm	BR/White	P.U. 195,00	019.1020WO.003.54	5700K / 3000Lm / 21W	1020mm	BR/White	P.U. 266,00
019.0520ACO.003.54	5700K / 1500Lm / 11W	520mm	Acet. Nat./ Nat.Satin	P.U. 195,00	019.1020ACO.003.54	5700K / 3000Lm / 21W	1020mm	Acet. Nat./Anodized	P.U. 266,00
019.1520WO.003.82	2700K / 4500Lm / 35W	1520mm	BR/White	P.U. 290,00	019.2520WO.003.82	2700K / 7500Lm / 55W	2520mm	BR/White	P.U. 538,00
019.1520ACO.003.82	2700K / 4500Lm / 35W	1520mm	Acet. Nat./ Nat. Satin	P.U. 290,00	019.2520ACO.003.82	2700K / 7500Lm / 55W	2520mm	Acet. Nat./Anodized	P.U. 538,00
019.1520WO.003.84	4000K / 4500Lm / 35W	1520mm	BR/White	P.U. 290,00	019.2520WO.003.84	4000K / 7500Lm / 55W	2520mm	BR/White	P.U. 538,00
019.1520ACO.003.84	4000K / 4500Lm / 35W	1520mm	Acet. Nat./ Nat.Satin	P.U. 290,00	019.2520ACO.003.84	4000K / 7500Lm / 55W	2520mm	Acet. Nat./Anodized	P.U. 538,00
019.1520WO.003.54	5700K / 4500Lm / 35W	1520mm	BR/White	P.U. 290,00	019.2520WO.003.54	5700K / 7500Lm / 55W	2520mm	BR/White	P.U. 538,00
019.1520ACO.003.54	5700K / 4500Lm / 35W	1520mm	Acet. Nat./ Nat. Satin	P.U. 290,00	019.2520ACO.003.54	5700K / 7500Lm / 55W	2520mm	Acet. Nat./Anodized	P.U. 538,00
019.2020WO.003.82	2700K / 6000Lm / 45W	2020mm	BR/White	P.U. 416,00	019.3020WO.003.82	2700K / 9000Lm / 65W	3020mm	BR/White	P.U. 575,00
019.2020ACO.003.82	2700K / 6000Lm / 45W	2020mm	Acet. Nat./ Nat. Satin	P.U. 416,00	019.3020ACO.003.82	2700K / 9000Lm / 65W	3020mm	Acet. Nat./Anodized	P.U. 575,00
019.2020WO.003.84	4000K / 6000Lm / 45W	2020mm	BR/White	P.U. 416,00	019.3020WO.003.84	4000K / 9000Lm / 65W	3020mm	BR/White	P.U. 575,00
019.2020ACO.003084	4000K / 6000Lm / 45W	2020mm	Acet. Nat./ Nat. Satin	P.U. 416,00	019.3020ACO.003.84	4000K / 9000Lm / 65W	3020mm	Acet. Nat./Anodized	P.U. 575,00
019.2020WO.003054	5700K / 6000Lm / 45W	2020mm	BR/White	P.U. 416,00	019.3020WO.003.54	5700K / 9000Lm / 65W	3020mm	BR/White	P.U. 575,00
019.2020ACO.003054	5700K / 6000Lm / 45W	2020mm	Acet. Nat./Anodized Antr./Dark Grey	P.U. 416,00	019.3020ACO.003.54	5700K / 9000Lm / 65W	3020mm	Acet. Nat./Anodized	P.U. 575,00

Opções por Encomenda: Dimensões Específicas (mínimo 56mm) - Kit de Emergência - DALI - Dimável - Sistema de controle de Iluminação (lux contol)

Obs: Não ligar com Sensores

Devido à constante evolução deste tipo de produtos e marca dos Led's e Drivers assim como as características técnicas podem ser alterados sem aviso prévio, por favor consultar o folheto ou solicitar a ficha técnica actualizada dos artigos pretendidos.



Perfil em Alumínio para Fita Flexível, não Electrificado
Aluminium Profile for flexível Strip. Without Assembled



Lapa 76

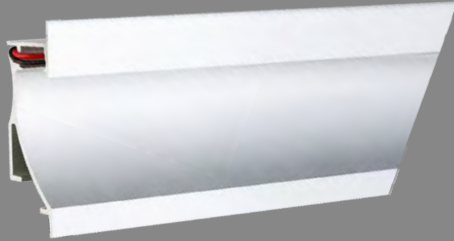
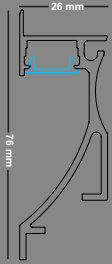

Perfil de Alumínio (Rodapé) com Difusor e sem Barra Led

Código/Code	Led / Lm / W	L	Cor/Color	€
020.0500WO.000.00	Sem Led / Empty	500mm	BR/White	P.U. 25,00
020.0500ACO.000.00	Sem Led / Empty	500mm	Acet. Nat. / Nat.Satin	P.U. 25,00
020.1000WO.000.00	Sem Led / Empty	1000mm	BR/White	P.U. 50,00
020.1000ACO.000.00	Sem Led / Empty	1000mm	Acet. Nat. / Nat.Satin	P.U. 50,00
020.1500WO.000.00	Sem Led / Empty	1500mm	BR/White	P.U. 75,00
020.1500ACO.000.00	Sem Led / Empty	1500mm	Acet. Nat. / Nat.Satin	P.U. 75,00
020.2000WO.000.00	Sem Led / Empty	2000mm	BR/White	P.U. 100,00
020.2000ACO.000.00	Sem Led / Empty	2000mm	Acet. Nat. / Nat.Satin	P.U. 100,00
020.2500WO.000.00	Sem Led / Empty	2500mm	BR/White	P.U. 125,00
020.2500ACO.000.00	Sem Led / Empty	2500mm	Acet. Nat. / Nat.Satin Antr./Dark Grey	P.U. 125,00
020.3000WO.000.00	Sem Led / Empty	3000mm	BR/White	P.U. 150,00
020.3000ACO.000.00	Sem Led / Empty	3000mm	Acet. Nat. / Nat.Satin	P.U. 150,00
020.TOPOWO.000.00	Sem Led / Empty		BR/White	P.U. 7,00
020.TOPOACO.000.00	Sem Led / Empty		Acet. Nat. / Nat.Satin	P.U. 7,00

Chelas 18

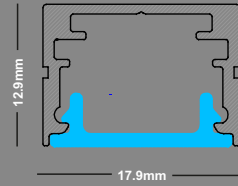

Perfil de Alumínio com Difusor e sem Barra Led
Aluminium profile with Difusor, without Led

097.1000ACO.000	Difusor Opalino	1000mm	Acet. Nat./Anodized	€ P.U. 8,50
097.2000ACO.000	Difusor Opalino	2000mm	Acet. Nat./Anodized	P.U. 17,00
097.1000WO.000	Difusor Opalino	1000mm	Branco	P.U. 8,50
097.2000WO.000	Difusor Opalino	2000mm	Branco	P.U. 17,00
097.1000ACC.000	Difusor Transparente	1000mm	Acet. Nat./Anodized	P.U. 8,50
097.2000ACC.000	Difusor Transparente	2000mm	Acet. Nat./Anodized	P.U. 17,00
097.1000WC.000	Difusor Transparente	1000mm	Branco	P.U. 8,50
097.2000WC.000	Difusor Transparente	2000mm	Branco	P.U. 17,00
097.TOPO.ACO.000	Topo			P.U. 0,70
097.MOLA.AC.O.000	Mola Fixação			P.U. 0,70

Chelas 25

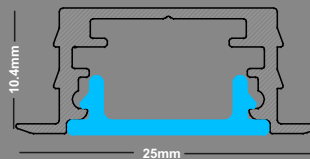

Perfil de Alumínio com Difusor e sem Barra Led
Aluminium profile with Difusor, without Led

098.1000ACO.000	Difusor Opalino	1000mm	Acet. Nat./Anodized	€ P.U. 8,50
098.2000ACO.000	Difusor Opalino	2000mm	Acet. Nat./Anodized	P.U. 17,00
098.1000ACC.000	Difusor Transparente	1000mm	Acet. Nat./Anodized	P.U. 8,50
098.2000ACC.000	Difusor Transparente	2000mm	Acet. Nat./Anodized	P.U. 17,00
098.TOPO.AC.O.000	098.TOPO.AC.O.000	Topo		P.U. 0,70
098.MOLA.AC.O.000	098.MOLA.AC.O.000	Mola Fixação		P.U. 0,70

Chelas 28

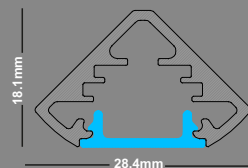

Perfil de Alumínio com Difusor e sem Barra Led
Aluminium profile with Difusor, without Led

099.1000ACO.000	Difusor Opalino	1000mm	Acet. Nat./Anodized	€ P.U. 17,00
099.2000ACO.000	Difusor Opalino	2000mm	Acet. Nat./Anodized	P.U. 34,00
099.1000ACC.000	Difusor Transparente	1000mm	Acet. Nat./Anodized	P.U. 17,00
099.2000ACC.000	Difusor Transparente	2000mm	Acet. Nat./Anodized	P.U. 34,00
099.TOPO.AC.O.000	Topo			P.U. 0,70
099.MOLA.AC.O.000	Mola Fixação			P.U. 0,70

Duogel 1000

1 L

Gel de Silicone Bicomponente

DESCRIÇÃO

Duogel 1000 é um gel bi componente de silicone utilizado no preenchimento para isolamento elétrica e vedação de baixa tensão até 1 kV.

Os dois componentes fornecidos nas embalagens, misturados na proporção 1:1 e garantem, graças a baixa viscosidade, um veloz e seguro preenchimento do recipiente a preencher.

Duogel 1000 pode ser utilizado parcialmente para mais aplicações de acordo com a necessidade de emprego. Duogel 1000 também pode ser facilmente removido, sem necessidade de ferramentas, mesmo depois de uma instalação longa.

CARACTERÍSTICAS TÉCNICAS

Rigidez dielétrica	25,5 kV/mm
Proporção de mistura	1:1
Cor	azul
Viscosidade A	2600 mPa
Viscosidade B	110 mPa
Tempo de trabalhabilidade a 23 °C	5 min
Tempo de polimerização a 23 °C	12 min
Temperatura de exercício	-60 °C / +200 °C

Nota: Temperaturas mais altas diminuem o tempo de trabalho e polimerização; Temperaturas mais baixas aumentam o tempo de trabalho e polimerização.



Código:SL-DUOGEL1000

Preço: 63,00€/Litro

UPS



UPS-OFF11-600VA

UPS Line-Interactive
Monofásica - 600Va
Bateria 12V / 1*7AH
230Vac / 50Hz
P.U. 105,00€

UPS-OFF11-1000VA

UPS Line-Interactive
Monifásica - 1000VA
Bateria 12V / 2*7AH
230Vc / 50Hz
P.U. 183,00€

UPS-OFF11-2000VA

UPS Line-Interactive
Monofásica - 2000VA
Bateria 12V / 2*9AH
230Vac / 50Hz
P.U. 255,00€

UPS-ON11-1K

UPS Smart On-Line
Bateria 12V / 2*9AH
Monofásica / Monofásica
1000VA / 230Vac / 50Hz
P.U. 595,00€

UPS-ON11-2K

UPS Smart On-Line
Bateria 12V / 4*9AH
Monofásica / Monofásica
2000VA / 230Vac / 50Hz
P.U. 865,00€

UPS-ON11-3K

UPS Smart On-Line
Bateria 12V / 6*9AH
Monofásica / Monofásica
3000VA / 230Vac / 50Hz
P.U. 1155,00€

UPS-ON11-6K

UPS Smart On-Line
Bateria 12V / 16*7AH
Monofásica / Monofásica
6000VA / 230Vac / 50Hz
P.U. 2130,00€

UPS-ON11-10K

UPS Smart On-Line
Bateria 12V / 16*9AH
Monofásica / Monofásica
10 000VA / 230Vac / 50Hz
P.U.2800,00€

UPS-ON101-1K

UPS on-line p/RACK
Bateria 12V / 2*9AH
Monofásica / Monofásica
1000VA / 230Vac / 50Hz
P.U. 750,00€

UPS-ON101-2K

UPS on-line p/ RACK
Bateria 12V / 4*9AH
Monofásica / Monofásica
2000VA / 230Vac / 50Hz
P.U. 1140,00€

UPS-ON101-3K

UPS on-line p/RACK
Bateria 12V / 6*9AH
Monofásica / Monofásica
3000VA / 230Vac / 50Hz
P.U. 1440,00€

Blocos de Tomadas com Cabo

soflight®
Electric



SL-E1315B

Bloco 3 Tomadas Schuko
Com Alvéolos Protegidos
Branco - 1,5 mts
Cabo H05VV-F 3G1,5
10/16A - 250Vac - 3680W
Quantidade Caixa: 40 pcs
P.U. 7,50€



SL-E1415B

Bloco 4 Tomadas Schuko
Com Alvéolos Protegidos
Branco - 1,5 mts
Cabo H05VV-F 3G1,5
10/16A - 250Vac - 3680W
Quantidade Caixa: 40 pcs
P.U. 9,00€



SL-E1515B

Bloco 5 Tomadas Schuko
Com Alvéolo Protegidos
Branco - 1,5 mts
Cabo H05VV-F 3G1,5
10/16A - 250Vac - 3680W
Quantidade Caixa: 40 pcs
P.U. 10,10€



SL-E1615B

Bloco 6 Tomadas Schuko
Com Alvéolos Protegidos
Branco - 1,5 mts
Cabo H05VV-F 3G1,5
10/16A - 250Vac - 3680W
Quantidade Caixa: 40 pcs
P.U. 10,90€

SL-E1330B

Bloco 3 Tomadas Schuko
Com Alvéolos Protegidos
Branco - 3 mts
Cabo H05VV-F 3G1,5
10/16A - 250Vac - 3680W
Quantidade Caixa: 30 pcs
P.U. 10,80€

SL-E1430B

Bloco 4 Tomadas Schuko
Com Alvéolos Protegidos
Branco - 3 mts
Cabo H05VV-F 3G1,5
10/16A - 250Vac - 3680W
Quantidade Caixa: 30 pcs
P.U. 12,85€

SL-E1530B

Bloco 5 Tomadas Schuko
Com Alvéolo Protegidos
Branco - 3 mts
Cabo H05VV-F 3G1,5
10/16A - 250Vac - 3680W
Quantidade Caixa: 30 pcs
P.U. 14,20€

SL-E1630B

Bloco 6 Tomadas Schuko
Com Alvéolos Protegidos
Branco - 3 mts
Cabo H05VV-F 3G1,5
10/16A - 250Vac - 3680W
Quantidade Caixa: 30 pcs
P.U. 14,10€

SL-E1350B

Bloco 3 Tomadas Schuko
Com Alvéolos Protegidos
Branco - 5 mts
Cabo H05VV-F 3G1,5
10/16A - 250Vac - 3680W
Quantidade Caixa: 20 pcs
P.U. 15,70€

SL-E1450B

Bloco 4 Tomadas Schuko
Com Alvéolos Protegidos
Branco - 5 mts
Cabo H05VV-F 3G1,5
10/16A - 250Vac - 3680W
Quantidade Caixa: 20 pcs
P.U. 18,00€

SL-E1550B

Bloco 5 Tomadas Schuko
Com Alvéolo Protegidos
Branco - 5 mts
Cabo H05VV-F 3G1,5
10/16A - 250Vac - 3680W
Quantidade Caixa: 20 pcs
P.U. 17,70€

SL-E1650B

Bloco 6 Tomadas Schuko
Com Alvéolos Protegidos
Branco - 5 mts
Cabo H05VV-F 3G1,5
10/16A - 250Vac - 3680W
Quantidade Caixa: 20 pcs
P.U. 18,85€



SL-E2315B

Bloco 3 Tomadas Schuko
Com Alvéolos Protegidos
Com Interruptor
Branco - 1,5 mts
Cabo H05VV-F 3G1,5
10/16A - 250Vac - 3680W
Quantidade Caixa: 40 pcs
P.U. 8,35€



SL-E2415B

Bloco 4 Tomadas Schuko
Com Alvéolos Protegidos
Com Interruptor
Branco - 1,5 mts
Cabo H05VV-F 3G1,5
10/16A - 250Vac - 3680W
Quantidade Caixa: 40 pcs
P.U. 9,50€



SL-E2515B

Bloco 5 Tomadas Schuko
Com Alvéolo Protegidos
Com Interruptor
Branco - 1,5 mts
Cabo H05VV-F 3G1,5
10/16A - 250Vac - 3680W
Quantidade Caixa: 40 pcs
P.U. 10,80€



SL-E2615B

Bloco 6 Tomadas Schuko
Com Alvéolos Protegidos
Com Interruptor
Branco - 1,5 mts
Cabo H05VV-F 3G1,5
10/16A - 250Vac - 3680W
Quantidade Caixa: 40 pcs
P.U. 11,50€

SL-E2330B

Bloco 3 Tomadas Schuko
Com Alvéolos Protegidos
Com Interruptor
Branco - 3 mts
Cabo H05VV-F 3G1,5
10/16A - 250Vac - 3680W
Quantidade Caixa: 30 pcs
P.U. 11,65€

SL-E2430B

Bloco 4 Tomadas Schuko
Com Alvéolos Protegidos
Com Interruptor
Branco - 3 mts
Cabo H05VV-F 3G1,5
10/16A - 250Vac - 3680W
Quantidade Caixa: 30 pcs
P.U. 13,50€

SL-E2530B

Bloco 5 Tomadas Schuko
Com Alvéolo Protegidos
Com Interruptor
Branco - 3 mts
Cabo H05VV-F 3G1,5
10/16A - 250Vac - 3680W
Quantidade Caixa: 30 pcs
P.U. 13,80€

SL-E2630B

Bloco 6 Tomadas Schuko
Com Alvéolos Protegidos
Com Interruptor
Branco - 3 mts
Cabo H05VV-F 3G1,5
10/16A - 250Vac - 3680W
Quantidade Caixa: 30 pcs
P.U. 14,30€

SL-E2350B

Bloco 3 Tomadas Schuko
Com Alvéolos Protegidos
Com Interruptor
Branco - 5 mts
Cabo H05VV-F 3G1,5
10/16A - 250Vac - 3680W
Quantidade Caixa: 20 pcs
P.U. 17,00€

SL-E2450B

Bloco 4 Tomadas Schuko
Com Alvéolos Protegidos
Com Interruptor
Branco - 5 mts
Cabo H05VV-F 3G1,5
10/16A - 250Vac - 3680W
Quantidade Caixa: 20 pcs
P.U. 18,00€

SL-E2550B

Bloco 5 Tomadas Schuko
Com Alvéolo Protegidos
Com Interruptor
Branco - 5 mts
Cabo H05VV-F 3G1,5
10/16A - 250Vac - 3680W
Quantidade Caixa: 20 pcs
P.U. 18,65€

SL-E2650B

Bloco 6 Tomadas Schuko
Com Alvéolos Protegidos
Com Interruptor
Branco - 5 mts
Cabo H05VV-F 3G1,5
10/16A - 250Vac - 3680W
Quantidade Caixa: 20 pcs
P.U. 19,30€

Blocos Tomadas / Extensões



SL-E1315P
Bloco 3 Tomadas Schuko Com Alvéolos Protegidos Preto - 1,5 mts
Cabo H05VV-F 3G1,5
10/16A - 250Vac - 3680W
Quantidade Caixa: 40 pcs
P.U. 7,55€

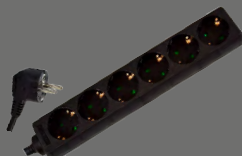

SL-E1615P
Bloco 6 Tomadas Schuko Com Alvéolos Protegidos Preto - 1,5 mts
Cabo H05VV-F 3G1,5
10/16A - 250Vac - 3680W
Quantidade Caixa: 40 pcs
P.U. 11,15€



SL-E1200B
Bloco 2 Tomadas Schuko Branco - sem Cabo
10 / 16A - 250Vac - 3680W
Quantidade Caixa: 200pcs
P.U. 3,25€



SL-E1300B
Bloco 3 Tomadas Schuko Branco - sem Cabo
10 / 16A - 250Vac - 3680W
Quantidade Caixa: 160 pcs
P.U. 3,60€



SL-E1350P
Bloco 3 Tomadas Schuko Com Alvéolos Protegidos Preto - 5 mts
Cabo H05VV-F 3G1,5
10/16A - 250Vac - 3680W
quantidade Caixa: 20 pcs
P.U. 16,00€



SL-E1650P
Bloco 6 Tomadas Schuko Com Alvéolos Protegidos Preto - 5 mts
Cabo H05VV-F 3G1,5
10/16A - 250Vac - 3680W
Quantidade Caixa: 20 pcs
P.U. 19,10€



SL-E1400B
Bloco 4 Tomadas Schuko Branco - sem Cabo
10 / 16A - 250Vac - 3680W
Quantidade Caixa: 120 pcs
P.U. 4,65€



SL-E1500B
Bloco 5 Tomadas Schuko Branco - sem Cabo
10 / 16A - 250Vac - 3680W
Quantidade Caixa: 60 pcs
P.U. 5,25€



SL-E6015B
Bloco 3 Tomadas Schuko Com Alvéolos Protegidos Branco - 1,5 mts
Cabo H05VV-F 3G1.5
Com Inter. Independentes
10 / 16A - 250Vac - 3680W
Quant. Caixa: 20 pcs
P.U. 20,80€



SL-E6050B
Bloco 6 Tomadas Schuko Com Alvéolos Protegidos Branco - 1,5 mts
Cabo H05VV-F 3G1.5
Com Inter. Independentes
10 / 16A - 250Vac - 3680W
Quant. Caixa: 20 pcs
P.U. 36,90€



SL-E7015B
Bloco 5 Tomadas Schuko Com Alvéolos Protegidos Branco - 1,5 mts; C/ Int.
Cabo H05VV-F 3G1.5
5 Tom.Schuko 16A
2 USB, 5VDC, Max.2,1A
10 / 16A - 250Vac - 3680W
Quant. Caixa: 30 pcs
P.U. 33,50€



SL-E8000B
Adaptador Com Alvéolos Protegidos
1 tom. Schuko 16A + 2 USB 5Vdc
2 USB 5Vdc, Max. 2,4A
Suporte p/ TLM + Lux presença
Lux presença Aut- < 10lux
10 / 16A - 110/230Vac 50/60Hz
Quant. Caixa: 50 pcs
P.U. 21,55€



SL-E8014B
Suporte E14 com Anilha Branca - 2A 250Vac
Quant.Emb./Cx:50/200pcs
P.U. 0,77€

Quantidade Mínima 50 Unid.



SL-E8027B
Suporte E27 com Anilha Branca - 2A 250Vac
Quant.Emb./Cx:50/200pcs
P.U. 0,88€

Quantidade Mínima 50 Unid.



SL-E8114B
Suporte E14 Branco - 2A 250Vac
Quant.Emb./Cx:50/200pcs
P.U. 0,49€

Quantidade Mínima 50 Unid.



SL-E8127B
Suporte E27 Branco - 2A 250Vac
Quant.Emb./Cx:50/200pcs
P.U. 0,74€

Quantidade Mínima 50 Unid.

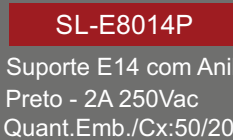

SL-E8014P
Suporte E14 com Anilha Preto - 2A 250Vac
Quant.Emb./Cx:50/200pcs
P.U. 0,77€

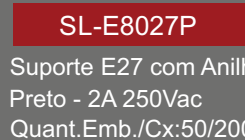

SL-E8027P
Suporte E27 com Anilha Preto - 2A 250Vac
Quant.Emb./Cx:50/200pcs
P.U. 0,88€

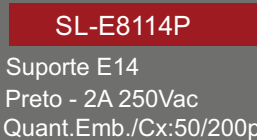

SL-E8114P
Suporte E14 Preto - 2A 250Vac
Quant.Emb./Cx:50/200pcs
P.U. 0,49€

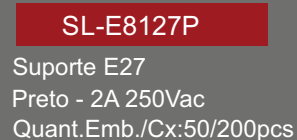

SL-E8127P
Suporte E27 Preto - 2A 250Vac
Quant.Emb./Cx:50/200pcs
P.U. 0,74€



SL-E4010P

Enrolador c/4 Tomadas Preto - 10 mts
Cabo H05VV-F 3G1,5
10/16A - 250Vac-3680W
Quant. Caixa: 5 pcs

P.U. 35,50€



SL-E4025P

Enrolador c/4 Tomadas Preto - 25 mts
Cabo H05VV-F 3G1,5
10/16A - 250Vac-3680W
Quant. Caixa: 1 pcs

P.U. 71,80€



SL-E4050P

Enrolador c/4 Tomadas Preto - 50 mts
Cabo H05VV-F 3G1,5
10/16A - 250Vac-3680W
Quant. Caixa: 1 pcs

P.U. 116,50€



SL-E4125P

Enrolador c/4 Tomadas Preto - 25 mts
Cabo H05VV-F 3G2,5
10/16A - 250Vac-3680W
Quant. Caixa: 1 pcs

P.U. 123,00€



SL-E4140P

Enrolador c/4 Tomadas Preto - 40 mts
Cabo H05VV-F 3G2,5
10/16A - 250Vac-3680W
Quant. Caixa: 1 pcs

P.U. 181,20€



SL-E8040B

Ficha Fêmea Schuko Branca - 16A 250Vac
Qt.Emb./Cx:30/300pcs

P.U. 1,50€



SL-E8050B

Ficha Macho Schuko Branca - 16A 250Vac
Qt.Emb./Cx:30/300pcs

P.U. 1,35€



SL-E8150B

Fi. Macho Schuko Branca - 16A 250Vac-Saída Lateral
Qt.Emb./Cx:30/300pcs

P.U. 1,25€



SL-E8060P

Ficha Macho Schuko Borracha-16A 250Vac
Qt.Emb./Cx:20/200pcs

P.U. 1,50€



SL-E8073P

Bloco Triplo em Borracha 16A 250Vac - IP44
Quant.Emb.:4/40pcs

P.U. 8,70€

SL-E8040P

Ficha Fêmea Schuko Preto - 16A 250Vac
Qt.Emb./Cx:30/300pcs

P.U. 1,50€

SL-E8050P

Ficha Macho Schuko Preto - 16A 250Vac
Qt.Emb./Cx:30/300pcs

P.U. 1,35€

SL-E8150P

Fi. Macho Schuko Preto - 16A 250Vac-Saída Lateral
Qt.Emb./Cx:30/300pcs

P.U. 1,25€



SL-E8070P

Ficha Fêmea Schuko Borracha-16A 250Vac
Qt.Emb./Cx:20/300pcs

P.U. 1,85€



SL-E5002T

Ficha Dupla Schuko 10/16A-250Vac-3500W
Quant. Caixa: 100 pcs

P.U. 2,80€



SL-E5002L

Ficha Dupla Schuko 10/16A-250Vac-3500W
Quant. Caixa: 100 pcs

P.U. 2,80€



SL-E5003T

Ficha Tripla Schuko 10/16A-250Vac-3500W
Quant. Caixa: 100 pcs

P.U. 4,20€



SL-E5003L

Ficha Tripla Schuko 10/16A-250Vac-3500W
Quant. Caixa: 100 pcs

P.U. 3,90€



SL-E8160P

Ficha Macho em Borracha Saída Lateral-16A 250Vac IP 44
Quant.Emb./Cx:20/200pcs

P.U. 2,15€



SL-E3003B

Extens.Macho/Fêmea Branca - 3 mts
Cabo H05VV-F 3x1,5
10/16A-250Vac-3680W
Quant. Caixa: 20 pcs

P.U. 9,90€



SL-E3005B

Extens.Macho/Fêmea Branca - 5 mts
Cabo H05VV-F 3G1,5
10/16A-250Vac-3680W
Quant. Caixa: 20 pcs

P.U. 14,60€



SL-E3010B

Extens.Macho/Fêmea Branca - 10 mts
Cabo H05VV-F 3G1,5
10/16A-250Vac-3680W
Quant. Caixa: 10 pcs

P.U. 23,00€



SL-E3015B

Extens.Macho/Fêmea Branca - 15 mts
Cabo H05VV-F 3G1,5
10/16A-250Vac-3680W
Quant. Caixa: 4 pcs

P.U. 34,00€



SL-E3020B

Extens.Macho/Fêmea Preta - 20 mts
Cabo H05VV-F 3G1,5
10/16A-250Vac-3680W
Quant. Caixa: 4 pcs

P.U. 43,10€

SL-E3003P

Extens.Macho/Fêmea Preta - 3 mts
Cabo H05VV-F 3x1,5
10/16A-250Vac-3680W
Quant. Caixa: 20 pcs

P.U. 9,90€

SL-E3005P

Extens.Macho/Fêmea Preta - 5 mts
Cabo H05VV-F 3G1,5
10/16A-250Vac-3680W
Quant. Caixa: 20 pcs

P.U. 14,60€

SL-E3010P

Extens.Macho/Fêmea Preta - 10 mts
Cabo H05VV-F 3G1,5
10/16A-250Vac-3680W
Quant. Caixa: 10 pcs

P.U. 23,00€

SL-E3015P

Extens.Macho/Fêmea Preta - 15 mts
Cabo H05VV-F 3G1,5
10/16A-250Vac-3680W
Quant. Caixa: 4 pcs

P.U. 34,00€

SL-E3020P

Extens.Macho/Fêmea Preta - 20 mts
Cabo H05VV-F 3G1,5
10/16A-250Vac-3680W
Quant. Caixa: 4 pcs

P.U. 43,10€

Quantidade Mínima 30 Unid.

Quantidade Mínima 30 Unid.

Quantidade Mínima 30 Unid.

Quantidade Mínima 30 Unid.

Ligadores



SL-L2221-2P

Ligador Rápido p/fio
c/ Patilha Flexível 2P
Quant. Emb.100/7000
P.U. 0,25€

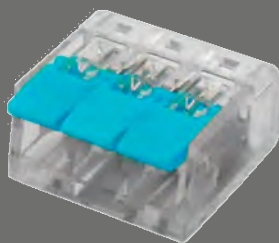

SL-L2221-3P

Ligador Rápido p/fio
c/ Patilha Flexível 3P
Quant. Emb. 100/7000
P.U. 0,33€

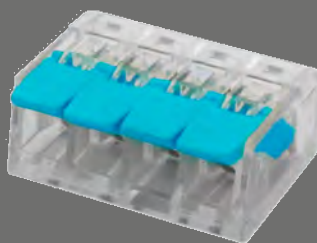

SL-L2221-4P

Ligador Rápido p/fio
c/ Patilha Flexível 4P
Quant. Emb. 50/3500
P.U. 0,41€



SL-L2221-5P

Ligador Rápido p/fio
c/ Patilha Flexível 5P
Quant. Emb. 50/3500
P.U. 0,47€



SL-L1273-2P

Ligador Rápido p/fio
Rígido 2P
Quant. Emb.200/4000
P.U. 0,11€



SL-L1273-3P

Ligador Rápido p/fio
Rígido 3P
Quant. Emb.200/4000
P.U. 0,15€



SL-L1273-4P

Ligador Rápido p/fio
Rígido 4P
Quant. Emb.100/7000
P.U. 0,17€

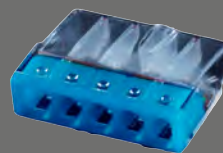

SL-L1273-5P

Ligador Rápido p/fio
Rígido 5P
Quant. Emb.100/7000
P.U. 0,20€



SL-L1273-8P

Ligador Rápido p/fio
Rígido 8P
Quant. Emb.100/7000
P.U. 0,30€



SL-CM16-3P

Conector M16 / IP 68 / 3P
Temp. Trab. -40° + 95°
450V / 15A
Cabo: Máx 2,5mm2
Quant. Emb.100Unid.
P.U. 4,00€



SL-EW-M20-3P

Conector M20 / IP 68 3P
Temp. Trab. -40° + 95°
450V / 15A
Cabo: Máx 2,5mm2
Quant. Emb. 10
P.U. 7,00€



SL-EW-2068-L-T

Caixa Derivação Vazia
Temp. Trab. -40° + 95°
450V / 20A
Cabo: Máx 2,5mm2
Quant. Emb. 10
P.U. 9,50€



SL-EW-M20-X-3P

Conector M20 / X / IP 68 / 3P
Temp. Trab. -40° + 95°
450V / 20A
Cabo: Máx 2,5mm2
Quant. Emb. 10
P.U. 17,00€



SL-CM20-3P

Conector M20 / IP 68 / 3P
Temp. Trab. -40° + 95°
450V / 20A
Cabo: Máx 2,5mm2
Quant. Emb.50Unid.
P.U. 4,90€



SL-EW-M25-5P

Conector M25 IP / 68 / 5P
Temp. Trab. -40° + 95°
450V / 20A
Cabo: Máx 2,5mm2
Quant. Emb. 10
P.U. 8,90€



SL-CM20-T-3P

Conector M20 T / IP 68 / 3P
Temp. Trab. -40° + 95°
450V / 20A
Cabo: Máx 2,5mm2
Quant. Emb. 10
P.U. 11,00€



SL-BJ 1004

Barra Junção 2,5-4mm
Quant. Emb.10/1000
P.U. 0,60€



SL-BJ 1006

Barra Junção 6mm
Quant. Emb. 10/1000
P.U. 0,75€



SL-BJ 1010

Barra Junção 10mm
Pquant. Emb. 10/500
P.U. 1,05€



SL-BJ 1016

Barra Junção 16mm
Quant. Emb. 10/500
P.U. 2,65€



Código	Dimensões	Quant./Emb.	IK	IP	P.U.€
SL-09-200200200	200x200x200mm	1	IK 10	IP 20	10,00€
SL-09-300300300	300x300x300mm	1	IK 10	IP 20	24,50€
SL-09-400400400	400x400x400mm	1	IK 10	IP 20	46,00€
SL-09-550550500	550x550x500mm	1	IK 10	IP 20	110,00€

soflight®

Electric Mobility

Estações Carregamento de Parede (Monofásicas 7,3KW)

Estações de Carregamento Tipo 2
 Alimentação cabo 3G6 (3P+N+T) 32A (Monofásica)
 Caixa de Controle norma SEA J 1772 2010
 Excelente desempenho de proteção, grau de proteção IP 55
 Tensão corrente nominal: 400Vac - 10 a 32A
 Carregamento 7,3KW (Máximo; 7,3Kw/h - 32A , Ajustável 6-10-16-20-25-32A)
 Resistência de Isolamento: > 1000 Ohm (500V DC)
 Caixa em Termoplástico, classe retardante de chama UI94 V-0
 Ficha de Carregamento: Contactos Liga de cobre , Prata + Termo plástico na parte superior
 Temperatura de Trabalho: -40° C ~ + 45° C
 Proteção contra vazamento (reiniciar carregamento)
 Proteção de subtensão de sobretensão (recuperação de autoverificação)
 Proteção contra sobrecarga (recuperação de autoverificação)
 Tipo Instalação: Poste (apropriado) / Parede
 Dimensões: 326mmx199mmx132mm
 Peso: 5,6Kgs



MBC-WB021F32A-10

- * Wall Box Monofásica 32A / 7,3Kw (Máximo)
- * Com Tomada Tipo 2 no painel
- * Sem Interruptor Diferencial
- * Ajustável 6 a 32A (2,1 a 7,3Kw)

P.U. 775,00€

MBC-WB021F32A-10D

- * Wall Box Monofásica 32A / 7,3Kw (Máximo)
- * Com Tomada Tipo 2 no painel
- * Com Interruptor Diferencial **TIPO B**
- * Ajustável 6 a 32A (2,1 a 7,3Kw)

P.U. 1100,00€

MBC-WB021F32A-15

- * Wall Box Monofásica 32A / 7,3Kw (Máximo)
- * Com Tomada Tipo 2 no painel
- * Sem Interruptor Diferencial
- * Ajustável 6 a 32A (2,1 a 7,3Kw)

* Com RFID
 P.U. 880,00€

MBC-WB021F32A-15D

- * Wall Box Monofásica 32A / 7,3Kw (Máximo)
- * Com Tomada Tipo 2 no painel
- * Com Interruptor Diferencial **TIPO B**
- * Ajustável 6 a 32A (2,1 a 7,3Kw)

* Com RFID
 P.U. 1230,00€



MBC-WB021F32A-20

- * Wall Box Monofásica 32A / 7,3Kw (Máximo)
- * Com 5 mts Cabo + Ficha Tipo 2
- * Sem Interruptor Diferencial
- * Ajustável 6 a 32A (2,1 a 7,3Kw)

P.U. 867,00€

MBC-WB021F32A-20D

- * Wall Box Monofásica 32A / 7,3Kw (Máximo)
- * Com 5 mts Cabo + Ficha Tipo 2
- * Com Interruptor Diferencial **TIPO B**
- * Ajustável 6 a 32A (2,1 a 7,3Kw)

P.U. 1230,00€

MBC-WB021F32A-25

- * Wall Box Monofásica 32A / 7,3Kw (Máximo)
- * Com 5 mts Cabo + Ficha Tipo 2
- * Sem Interruptor Diferencial
- * Ajustável 6 a 32A (2,1 a 7,3Kw)

* Com RFID
 P.U. 990,00€

MBC-WB021F32A-25D

- * Wall Box Monofásica 32A / 7,3Kw (Máximo)
- * Com 5 mts Cabo + Ficha Tipo 2
- * Com Interruptor Diferencial **TIPO B**
- * Ajustável 6 a 32A (2,1 a 7,3Kw)

* Com RFID
 P.U. 1330,00€

Com Controlo Dinâmico de Carregamento

MBC-WB021F32A-50

- * Wall Box Monofásica 32A / 7,3Kw (Máximo)
- * Com 5 mts Cabo + Ficha Tipo 2
- * Sem Interruptor Diferencial
- * Com Controlo Dinâmico de Carregamento
(Ajusta automaticamente o carregamento com a potência disponível na Instalação)
- * Display 4,3"
- * RFID

P.U. 2300,00€



Estações Carregamento de Parede (Trifásicas 22KW)

Estações de Carregamento Tipo 2

Alimentação cabo 5G6 (3P+N+T) 32A (Trifásica)
 Caixa de Controle norma SEA J 1772 2010
 Excelente desempenho de proteção, grau de proteção IP 55
 Tensão corrente nominal: 400Vac - 10 a 32A
 Carregamento 22KW (Máximo; 22Kw/h - 32A , Ajustável 6-10-16-20-25-32A)
 Resistência de Isolamento: > 1000 Ohm (500V DC)
 Caixa em Termoplástico, classe retardante de chama UI94 V-0
 Ficha de Carregamento: Contactos Liga de cobre , Prata + Termo plástico na parte superior
 Temperatura de Trabalho: -40° C ~ + 45° C
 Proteção contra vazamento (reeniciar carregamento)
 Proteção de subtensão de sobretensão (recuperação de autoverificação)
 Proteção contra sobrecarga (recuperação de autoverificação)
 Tipo Instalação: Poste (apropriado) / Parede
 Dimensões: 326mmx199mmx132mm
 Peso: 5,6Kgs



MBC-WB023F32A-10

- * Wall Box Trifásica 32A / 22Kw (Máximo)
- * Com Tomada Tipo 2 no painel
- * Sem Interruptor Diferencial
- * Ajustável 6 a 32A (2,1 a 22Kw)

P.U. 930,00€

MBC-WB023F32A-10D

- * Wall Box Trifásica 32A / 22Kw (Máximo)
- * Com Tomada Tipo 2 no painel
- * Com Interruptor Diferencial **TIPO B**
- * Ajustável 6 a 32A (2,1 a 22Kw)

P.U. 1250,00€

MBC-WB023F32A-15

- * Wall Box Trifásica 32A / 22Kw (Máximo)
- * Com Tomada Tipo 2 no painel
- * Sem Interruptor Diferencial
- * Ajustável 6 a 32A (2,1 a 22Kw)

* Com RFID
 P.U. 1015,00€

MBC-WB023F32A-15D

- * Wall Box Trifásica 32A / 22Kw (Máximo)
- * Com Tomada Tipo 2 no painel
- * Com Interruptor Diferencial **TIPO B**
- * Ajustável 6 a 32A (2,1 a 22Kw)

* Com RFID
 P.U. 1350,00€



MBC-WB023F32A-20

- * Wall Box Trifásica 32A / 22Kw (Máximo)
- * Com 5 mts Cabo + Ficha Tipo 2
- * Sem Interruptor Diferencial
- * Ajustável 6 a 32A (2,1 a 22Kw)

P.U. 1020,00€

MBC-WB023F32A-20D

- * Wall Box Trifásica 32A / 22Kw (Máximo)
- * Com 5 mts Cabo + Ficha Tipo 2
- * Com Interruptor Diferencial **TIPO B**
- * Ajustável 6 a 32A (2,1 a 22Kw)

P.U. 1330,00€

MBC-WB023F32A-25

- * Wall Box Trifásica 32A / 22Kw (Máximo)
- * Com 5 mts Cabo + Ficha Tipo 2
- * Sem Interruptor Diferencial
- * Ajustável 6 a 32A (2,1 a 22Kw)

* Com RFID
 P.U. 1150,00€

MBC-WB023F32A-25D

- * Wall Box Trifásica 32A / 22Kw (Máximo)
- * Com 5 mts Cabo + Ficha Tipo 2
- * Com Interruptor Diferencial **TIPO B**
- * Ajustável 6 a 32A (2,1 a 22Kw)

* Com RFID
 P.U. 1450,00€

Com Controlo Dinâmico de Carregamento

MBC-WB023F32A-50

- * Wall Box Trifásica 32A / 22Kw (Máximo)
- * Com 5 mts Cabo + Ficha Tipo 2
- * Sem Interruptor Diferencial
- * Com Controlo Dinâmico de Carregamento
 (Ajusta automaticamente o carregamento com a potencia disponível na Instalação)
- * Display 4,3"
- * RFID

P.U. 2400,00€



Carregadores Corrente Continua

soflight®

Electric Mobility

(Carregadores Rápidos em DC)



MBC-WBDC-15KW

Carregador Corrente Continua Ficha CCS 2
 3 Fases + N + PE
 Input: 400V +- 10%
 Output: 15Kw
 Ficha de Carregamento SEA J 1172 2010 Standard (CCS 2)
 Excelente desempenho de proteção, grau de proteção IP 54
 Tipo Instalação Parede ou Poste apropriado
 Display TFT Touch Sreen
 RFID Mifare (Classico, DesFire EV 1)
 Carregador, Model 4
 Dimensões: 610x430x205mm
P.U. s/consulta

MBC-WBDC-20KW

Carregador Corrente Continua Ficha CCS 2
 3 Fases + N + PE
 Input: 400V +- 10%
 Output: 20Kw
 Ficha de Carregamento SEA J 1172 2010 Standard (CCS 2)
 Excelente desempenho de proteção, grau de proteção IP 54
 Tipo Instalação Parede ou Poste apropriado
 Display TFT Touch Sreen
 RFID Mifare (Classico, DesFire EV 1)
 Carregador, Model 4
 Dimensões: 610x430x205mm
P.U. 15900,00€

MBC-WBDC-30KW

Carregador Corrente Continua Ficha CCS 2
 3 Fases + N + PE
 Input: 400V +- 10%
 Output: 30Kw
 Ficha de Carregamento SEA J 1172 2010 Standard (CCS 2)
 Excelente desempenho de proteção, grau de proteção IP 54
 Tipo Instalação Parede ou Poste apropriado
 Display TFT Touch Sreen
 RFID Mifare (Classico, DesFire EV 1)
 Carregador, Model 4
 Dimensões: 610x430x205mm
P.U. 20700,00€

MBC-WBDC-40KW

Carregador Corrente Continua Ficha CCS 2
 3 Fases + N + PE
 Input: 400V +- 10%
 Output: 40Kw
 Ficha de Carregamento SEA J 1172 2010 Standard (CCS 2)
 Excelente desempenho de proteção, grau de proteção IP 54
 Tipo Instalação Parede ou Poste apropriado
 Display TFT Touch Sreen
 RFID Mifare (Classico, DesFire EV 1)
 Carregador, Model 4
 Dimensões: 610x430x205mm
P.U. 25500,00€

Carregadores Portáteis

soflight®

Electric Mobility

MBC-POR021F32A

Carregador Portátil Tipo 2

P.U. 825,00€

MBC-POR011F32A

Carregador Portátil Tipo 1

P.U. 825,00€

Ficha de Carregamento SEA J 1172 2010 Standard (Tipo 2)
Ficha de Alimentação Tipo CEE 32A (Monofásico)
Caixa de Controle norma SEA J 1772 2010
Excelente desempenho de proteção, grau de proteção IP 55
Tensão corrente nominal: 230Vac - 32A
Carregamento Máximo; 7,2 Kw/h (Ajustável 2,2KW/h / 3,5Kw/h / 7,2Kw/h)
Resistência de Isolamento: > 1000Ohm (500V DC)
Caixa em Termoplástico, classe retardante de chama UL 94 V-0
Ficha de Carregamento: Contactos Liga de cobre , Prata + Termo plástico na parte superior
Temperatura de Trabalho: -30° C ~ + 50° C
Proteção contra vazamento (reiniciar carregamento)
Proteção de subtensão e de sobretensão (recuperação de autoverificação)
Proteção contra sobrecarga (recuperação de autoverificação)
Proteção de Iluminação (indicação em Led)



MBC-POR011F16A

Ficha Tipo 1

Carregador Portátil Tipo 1

P.U. 455,00€

MBC-POR021F16A

Ficha Tipo 2

Carregador Portátil Tipo 2

P.U. 455,00€

Ficha de Carregamento SEA J 1172 2010 Standard (Tipo 1 / Tipo 2)
Ficha de Alimentação Tipo Schuko 16A (Monofásico)
Caixa de Controle norma SEA J 1772 2010
Excelente desempenho de proteção, grau de proteção IP 55
Tensão corrente nominal: 230Vac - 16A
Carregamento Máximo: 3,5 Kw/h
Resistência de Isolamento: > 1000Ohm (500V DC)
Caixa em Termoplástico, classe retardante de chama UI94 V-0
Ficha de Carregamento: Contactos Liga de cobre , Prata + Termo plástico na parte superior
Temperatura de Trabalho: -30° C ~ + 50° C
Proteção contra vazamento (reiniciar carregamento)
Proteção de subtensão e de sobretensão (recuperação de autoverificação)
Proteção contra sobrecarga (recuperação de autoverificação)
Proteção de Iluminação (indicação em Led)



MBC-POR02332A

Carregador Portátil Trifásico

Tomada Tipo 2 SEA J 1172 2010 Standard (Tipo 2)

Alimentação cabo 5G6 (3P+N+T) 32A (Trifásico)

Caixa de Controle norma SEA J 1772 2010

Excelente desempenho de proteção, grau de proteção IP 55

Tensão corrente nominal: 400Vac - 10 a 32A

Carregamento Máximo; 22Kw/h - 32A (Ajustável 10-16-20-25-32A)

Resistência de Isolamento: > 1000 Ohm (500V DC)

Caixa em Termoplástico, classe retardante de chama UI94 V-0

Ficha de Carregamento: Contactos Liga de cobre , Prata + Termo plástico na parte superior

Temperatura de Trabalho: -40° C ~ + 45° C

Proteção contra vazamento (reiniciar carregamento)

Proteção de subtensão e de sobretensão (recuperação de autoverificação)

Proteção contra sobrecarga (recuperação de autoverificação)

Tipo Instalação: Poste (apropriado) / Parede

Dimensões: 326mmx199mmx132mm

Peso: 2,8Kgs

P.U. 1690,00€



MBC-CAB01021F16A

Cabo 3G2,5 com 5 mts Fichas Tipo 1 / Tipo 2
 Fichas de Carregamento conforme norma 62196-2 IEC 2010
 Design ergonómicos, portátil , fácil utilização
 Fiabilidade dos materiais:
 - Antiespuma, Resistência á Pressão; Resistência à Abrasão
 - Resistência ao Impacto, Resistência aos óleos
 Excelente desempenho de proteção, grau de proteção IP 55
 Tensão corrente nominal: 230Vac - 16A
 Corrente nominal: Máximo 16A (Monofásico)
 Carregamento Máximo; 3,5 Kw/h
 Resistência de Isolamento: > 500Ohm (500V DC)
 Caixa em Termoplástico, classe retardante de chama UI94 V-0
 Clástico, classe retardante de chama UL 94 V-0
 Temperatura de Trabalho: -30° C ~ + 50° C

P.U. 285,00€**MBC-CAB01021F32A**

Cabo 3G6 com 5 mts Fichas Tipo 1 / Tipo 2
 Fichas de Carregamento conforme norma 62196-2 IEC 2010
 Montagem conforme norma IEC 61851-1 2010 modo de Carregamento 3 método conexão B2
 Design ergonómicos, portátil , fácil utilização
 Fiabilidade dos materiais:
 - Antiespuma, Resistência á Pressão; Resistência à Abrasão
 - Resistência ao Impacto, Resistência aos óleos
 Excelente desempenho de proteção, grau de proteção IP 55
 Tensão corrente nominal: 250Vac / 415Vac - 32A
 Corrente nominal: Máximo 32A (Monofásico)
 Carregamento Máximo; 7,2 Kw/h
 Resistência de Isolamento: > 500Ohm (500V DC)
 Caixa em Termoplástico, classe retardante de chama UL 94 V-0
 Ficha de Carregamento: Contactos Liga de cobre , Prata + Termo plástico na parte superior
 Temperatura de Trabalho: -30° C ~ + 50° C

P.U. 330,00€**MBC-CAB02021F16A**

Cabo 3G2,5 com 5 mts Fichas Tipo 2 / Tipo 2
 Fichas de Carregamento conforme norma 62196-2 IEC 2010
 Montagem conforme norma IEC 61851-1 2010 modo de Carregamento 3 método conexão B2
 Design ergonómicos, portátil , fácil utilização
 Fiabilidade dos materiais:
 - Antiespuma, Resistência á Pressão; Resistência à Abrasão
 - Resistência ao Impacto, Resistência aos óleos
 Excelente desempenho de proteção, grau de proteção IP 55
 Tensão corrente nominal: 250Vac / 415Vac - 16A
 Corrente nominal: Máximo 16A (Monofásico)
 Carregamento Máximo; 3,5 Kw/h
 Resistência de Isolamento: > 500Ohm (500V DC)
 Caixa em Termoplástico, classe retardante de chama UI94 V-0
 Ficha de Carregamento: Contactos Liga de cobre , Prata + Termo plástico na parte superior
 Temperatura de Trabalho: -30° C ~ + 50° C

P.U. 285,00€

Cabos e Acessórios

soflight®

Electric Mobility

MBC-CAB02023F16A

Cabo 5G2,5 com 5 mts Fichas Tipo 2 / Tipo 2
 Fichas de Carregamento conforme norma 62196-2 IEC 2010
 Montagem conforme norma IEC 61851-1 2010 modo de Carregamento 3 método conexão B2
 Design ergonómicos, portátil , fácil utilização
 Fiabilidade dos materiais:
 - Antiespuma, Resistência á Pressão; Resistência à Abrasão
 - Resistência ao Impacto, Resistência aos óleos
 Excelente desempenho de proteção, grau de proteção IP 55
 Tensão corrente nominal: 250Vac / 415Vac - 16A
 Corrente nominal: Máximo 16A (Trifásico)
 Carregamento Máximo: 3,5 Kw/h
 Resistência de Isolamento: > 500Ohm (500V DC)
 Caixa em Termoplástico, classe retardante de chama UI94 V-0
 Clástico, classe retardante de chama UL 94 V-0
 Ficha de Carregamento: Contactos Liga de cobre , Prata + Termo plástico na parte superior
 Temperatura de Trabalho: -30° C ~ + 50° C
P.U. 340,00€



Novos
Podutos

Novos
Podutos

MBC-CAB02023F32A

Com 5mts Cabo 5G6 Fichas Tipo 2 / Tipo 2
P.U. 390,00

MBC-CAB02023F32A-7

Com 7mts Cabo 5G6 Fichas Tipo 2 / Tipo 2
P.U. 505,00

MBC-CAB02023F32A-10

Com 10mts Cabo 5G6 Fichas Tipo 2 / Tipo 2
P.U. 630,00



Cabo 5G6 Fichas Tipo 2 / Tipo 2
 Fichas de Carregamento conforme norma 62196-2 IEC 2010
 Montagem conforme norma IEC 61851-1 2010 modo de Carregamento 3 método conexão B2
 Design ergonómicos, portátil , fácil utilização
 Fiabilidade dos materiais:
 - Antiespuma, Resistência á Pressão; Resistência à Abrasão
 - Resistência ao Impacto, Resistência aos óleos
 Excelente desempenho de proteção, grau de proteção IP 55
 Tensão corrente nominal: 250Vac / 415Vac - 32A
 Corrente nominal: Máximo 32A (Trifásico)
 Carregamento Máximo; 22 Kw/h
 Resistência de Isolamento: > 500Ohm (500V DC)
 Caixa em Termoplástico, classe retardante de chama UI94 V-0
 Clástico, classe retardante de chama UL 94 V-0
 Ficha de Carregamento: Contactos Liga de cobre , Prata + Termo plástico na parte superior
 Temperatura de Trabalho: -30° C ~ + 50° C



MBC-FF023F32A

Ficha fêmea Tipo 2
 32A
 Trifásica
P.U. 140,00€



MBC-TE013F32A

Tomada Encastrar Tipo 1
 32A
P.U. 90,00€



MBC-FF013F32A

Ficha Fêmea Tipo 1
 32A
P.U. 135,00€



MBC-SUP-T2

Suporte para Ficha T2
P.U. 15,00€



MBC-FM023F32A

Ficha Macho Tipo 2
 32A
 Trifásica
P.U. 115,00€



MBC-TE023F32A

32A Trifásica
 Tomada Encastrar Tipo 2
P.U. 140,00€



Projetores em Gesso

Projetores em Gesso

soflight®

Electric Mobility

Projetores Fabricados em Gesso e Metal na Cor Branca. Podem ser Pintados à cor da Parede / Teto



SL-G1010

Proj. Redondo em Gesso
GU 10 - IP 20
Aro: 100mm
Furo: 100mm
Altura: 30mm
Quant. Emb.30 pcs
P.U. 10,30€



SL-G1015

Proj. Redondo em Gesso
GU 10 - IP 20
Aro: 100mm
Furo: 100mm
Altura: 40mm
Quant. Emb.24 pcs
P.U. 12,20€



SL-G1016

Proj. Redondo em Gesso
GU 10 - IP 20
Aro: 130mm
Furo: 130mm
Altura: 55mm
Quant. Emb.24 pcs
P.U. 16,75€



SL-G1020

Proj. Quadrado em Gesso
GU 10 - IP 20
Aro: 100x100mm
Furo: 100x100mm
Altura: 30mm
Quant. Emb.30 pcs
P.U. 10,30€



SL-G1022

Proj. Duplo em Gesso
Fixação no Teto
GU 10 - IP 20
Aro: 215x117mm
Altura: 57mm
Quant. Emb.12 pcs
P.U. 25,00€



SL-G1025

Proj. Quadrado em Gesso
GU 10 - IP 20
Aro: 100x120mm
Furo: 100x120mm
Altura: 40mm
Quant. Emb.24 pcs
P.U. 12,20€



SL-G1026

Proj. Redondo em Gesso
GU 10 - IP 20
Aro: 120x120mm
Furo: 120x120mm
Altura: 60mm
Quant. Emb.24 pcs
P.U. 16,80€



SL-G1030

Proj. Redondo em Gesso
GU 10 - IP 20
Aro: 120x120mm
Furo: 120x120mm
Altura: 60mm
Quant. Emb.24 pcs
P.U. 16,80€



SL-G1050

Proj. Redondo em Gesso
AR 111 - IP 20
Aro: 253mm
Furo: 253mm
Altura: 60mm
Quant. Emb.24 pcs
P.U. 59,40€



SL-G1060

Proj. Redondo em Gesso
AR 111 - IP 20
Aro: 202X202mm
Furo: 202X202mm
Altura: 90mm
Quant. Emb.24 pcs
P.U. 61,60€



SL-G1062

Proj. Redondo em Gesso
2x AR 111 - IP 20
Aro: 362X202mm
Furo: 362X202mm
Altura: 90mm
Quant. Emb.24 pcs
P.U. 88,30€



SL-G5050-B

Proj. Quadrado em Gesso
Fixação no Teto (Branco/Preto)
GU 10 - IP 20
Dimensão: 100x100mm
Comprimento: 170mm
Quant. Emb. 9 pcs
P.U. 48,00€



SL-G5050-C

Proj. Quadrado em Gesso
Fixa. no Teto (Branco/Cromado)
GU 10 - IP 20
Dimensão: 100x100mm
Comprimento: 170mm
Quant. Emb. 9 pcs
P.U. 48,00€



SL-G5050-G

Proj. Quadrado em Gesso
Fixa. no Teto (Branco/dourado)
GU 10 - IP 20
Dimensão: 100x100mm
Comprimento: 170mm
Quant. Emb. 9 pcs
P.U. 48,00€



SL-G2010

Proj. Redondo em Gesso
Fixação no Teto
GU 10 - IP 20
Diâmetro: 70mm
Comprimento: 220mm
Quant. Emb.18 pcs
P.U. 30,40€



SL-G2015

Proj. Redondo em Gesso
Fixação na Parede Down
GU 10 - IP 20
Diâmetro: 70mm
Comprimento: 220mm
Quant. Emb.18 pcs
P.U. 36,80€



SL-G2020

Proj. Redondo em Gesso
Fixação na Parede Up/down
2xGU 10 - IP 20
Diâmetro: 70mm
Comprimento: 220mm
Quant. Emb.18 pcs
P.U. 36,80€



SL-G2025

Proj. Redondo em Gesso
Suspensão
GU 10 - IP 20
Diâmetro: 70mm
Comprimento: 220mm
Quant. Emb.9 pcs
P.U. 46,30€

Projetores em Gesso

Projetores Fabricados em Gesso e Metal na Cor Branca. Podem ser Pintados à cor da Parede / Teto



SL-G3010

Projetor Quadrado em Gesso
Fixação no Teto
GU 10 - IP 20
Dimensões: 70x70mm
Comprimento: 220mm
Quant. Emb.18 pcs
P.U. 30,40€



SL-G3015

Proj. Quadrado em Gesso
Fixação na Parede Down
GU 10 - IP 20
Dimensões: 70x70mm
Comprimento: 220mm
Quant. Emb.18 pcs
P.U. 34,00€



SL-G3020

Proj. Quadrado em Gesso
Fixação na Parede Up/down
2xGU 10 - IP 20
Dimensões: 70x70mm
Comprimento: 220mm
Quant. Emb.18 pcs
P.U. 37,00€



SL-G3025

Proj. Quadrado em Gesso
Suspensão
GU 10 - IP 20
Dimensões: 70x70mm
Comprimento: 220mm
Quant. Emb.9 pcs
P.U. 46,50€



SL-G5015

Projetor Quadrado em Gesso
Fixação Parede Up/Down
G 9 - IP 20
Dimensões: 115x115mm
Comprimento: 115mm
Quant. Emb.12 pcs
P.U. 30,40€



SL-G5020

Proj. Oval em Gesso
Fixação na Parede Up/Down
G 9 - IP 20
Dimensões: 200x120mm
Profundidade: 80mm
Quant. Emb.12 pcs
P.U. 37,00€



SL-G5025

Proj. Rectangular em Gesso
Fixação na Parede Up/down
E14 - IP 20
Dimensões: 90x90mm
Comprimento: 245mm
Quant. Emb.9 pcs
P.U. 40,00€



SL-G9010

Proj. Parede em Gesso
Embutir na Parede (Down)
GU 10(35mm) - IP 20
Dimensões: 100x100mm
Profundidade: 40mm
Quant. Emb.50 pcs
P.U. 12,50€



SL-G9020

Projetor Quadrado em Gesso
Embutir na Parede (Down)
GU 10(35mm) - IP 20
Dimensões: 245x110mm
Profundidade: 50mm
Quant. Emb.12 pcs
P.U. 30,50€



SL-G6010

Suspensão em Gesso
Suspensão
G 9 - IP 20
Diâmetro: 230mm
Comprimento: 120mm
Quant. Emb.8 pcs
P.U. 75,00€



SL-G6020

Suspensão em Gesso
Suspensão
E14 - IP 20
Diâmetro: 150mm
Comprimento: 250mm
Quant. Emb.4 pcs
P.U. 79,00€



Downlight Baixo Perfil Saliente IP 44



SL60011BR-S-9W-84

4200K, 900lm, 9W
Branco
Diâmetro: 120mm
Altura 35mm
Quant. Emb.50 pcs
P.U. 11,90€



SL60011AE-S-9W-84

4200K, 900lm, 9W
Aço Escovado
Diâmetro: 120mm
Altura 35mm
Quant. Emb.50 pcs
P.U. 15,00€



SL70011BR-S-9W-84

4200K, 900lm, 9W
Branco
Dimensões: 125x125mm
Altura 36mm
Quant. Emb.50 pcs
P.U. 15,50€



SL70011AE-S-9W-84

4200K, 900lm, 9W
Aço Escovado
Dimensões: 125x125mm
Altura 36mm
Quant. Emb.50 pcs
P.U. 18,80€



SL60011BR-S-20W-84

4200K, 1500lm, 20W
Branco
Diâmetro: 225mm
Altura 35mm
Quant. Emb.20 pcs
P.U. 21,90€

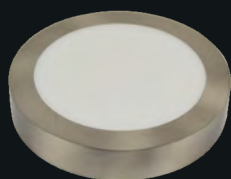

SL60011AE-S-20W-84

4200K, 1500lm, 20W
Aço Escovado
Diâmetro: 225mm
Altura 35mm
Quant. Emb.20 pcs
P.U. 27,10€



SL70011BR-S-20W-84

4200K, 1500lm, 20W
Branco
Dimensões: 225x225mm
Altura 36mm
Quant. Emb.20 pcs
P.U. 24,50€



SL70011AE-S-20W-84

4200K, 1500lm, 20W
Aço Escovado
Dimensões: 225x225mm
Altura 36mm
Quant. Emb.20 pcs
P.U. 30,90€

soflight®
Lighting

Downlight Baixo Perfil Led



SL60011BR-3W-82

2700K, 345lm, 3W
Branco / IP 44
Aro: 85mm
Furo: 75mm
Altura: 13mm
Quant. Emb.50 pcs
P.U. 9,50€



SL60011BR-5W-82

2700K, 400lm, 5W
Branco / IP 44
Aro: 85mm
Furo: 75mm
Altura: 13mm
Quant. Emb.50 pcs
P.U. 12,00€



SL60011BR-9W-82

2700K, 690lm, 9W
Branco / IP 44
Aro.: 120mm
Furo: 105mm
Altura: 13mm
Quant. Emb.50 pcs
P.U. 8,95€



SL60011BR-12W-82

2700K, 1380lm, 12W
Branco / IP 44
Aro: 170mm
Furo: 160mm
Altura: 13mm
Quant. Emb.20 pcs
P.U. 11,75€



SL60011BR-20W-82

2700K, 2070lm, 20W
Branco / IP 44
Aro: 225mm
Furo: 205mm
Altura: 13mm
Quant. Emb.20 pcs
P.U. 15,30€

SL60011BR-3W-84

4200K, 345lm, 3W
Branco / IP 44
Aro: 85mm
Furo: 75mm
Altura: 13mm
Quant. Emb.50 pcs
P.U. 9,50€

SL60011BR-5W-84

4200K, 400lm, 5W
Branco / IP 44
Aro: 85mm
Furo: 75mm
Altura: 13mm
Quant. Emb.50 pcs
P.U. 12,00€

SL60011BR-9W-84

4200K, 690lm, 9W
Branco / IP 44
Aro.: 120mm
Furo: 105mm
Altura: 13mm
Quant. Emb.50 pcs
P.U. 8,95€

SL60011BR-12W-84

4200K, 1380lm, 12W
Branco / IP 44
Aro: 170mm
Furo: 160mm
Altura: 13mm
Quant. Emb.20 pcs
P.U. 11,75€

SL60011BR-20W-84

4200K, 2070lm, 20W
Branco / IP 44
Aro: 225mm
Furo: 205mm
Altura: 13mm
Quant. Emb.20 pcs
P.U. 15,30€

Downlight Baixo Perfil Dimável

SL60011BR-5W-82-D

2700K, 690lm, 9W
Branco / IP 44
P.U. 26,75€

SL60011BR-12W-82-D

2700K, 920lm, 12W
Branco / IP 44
P.U. 27,30€

SL60011BR-5W-84-D

4200K, 600lm, 9W
Branco / IP 44
P.U. 26,75€

SL60011BR-12W-84-D

4200K, 1380lm, 12W
Branco / IP 44
P.U. 27,30€

SL60011BR-9W-82-D

2700K, 690lm, 9W
Branco / IP 44
P.U. 24,65€

SL60011BR-20W-82-D

2700K, 1500lm, 20W
Branco / IP 44
P.U. 36,20€

SL60011BR-9W-84-D

4200K, 600lm, 9W
Branco / IP 44
P.U. 24,65€

SL60011BR-20W-84-D

4200K, 2070lm, 20W
Branco / IP 44
P.U. 36,20€



SL60011AE-3W-82

2700K, 345lm, 3W
Aço Escovado / IP 44
Aro: 85mm
Furo: 75mm
Altura: 13mm
Quant. Emb.50 pcs
P.U. 10,30€



SL60011AE-5W-82

2700K, 400lm, 5W
Aço Escovado / IP 44
Aro: 85mm
Furo: 75mm
Altura: 13mm
Quant. Emb.50 pcs
P.U. 13,20€



SL60011AE-9W-82

2700K, 690lm, 9W
Aço Escovado / IP 44
Aro.: 120mm
Furo: 105mm
Altura: 13mm
Quant. Emb.50 pcs
P.U. 11,40€



SL60011AE-12W-82

2700K, 1380lm, 12W
Aço Escovado / IP 44
Aro: 170mm
Furo: 160mm
Altura: 13mm
Quant. Emb.20 pcs
P.U. 17,90€



SL60011AE-20W-82

2700K, 2070lm, 20W
Aço Escovado / IP 44
Aro: 225mm
Furo: 205mm
Altura: 13mm
Quant. Emb.20 pcs
P.U. 21,70€

SL60011AE-3W-84

4200K, 345lm, 3W
Aço Escovado / IP 44
Aro: 85mm
Furo: 75mm
Altura: 13mm
Quant. Emb.50 pcs
P.U. 10,30€

SL60011AE-5W-84

4200K, 400lm, 5W
Aço Escovado / IP 44
Aro: 85mm
Furo: 75mm
Altura: 13mm
Quant. Emb.50 pcs
P.U. 13,20€

SL60011AE-9W-84

4200K, 690lm, 9W
Aço Escovado / IP 44
Aro.: 120mm
Furo: 105mm
Altura: 13mm
Quant. Emb.50 pcs
P.U. 11,40€

SL60011AE-12W-84

4200K, 1380lm, 12W
Aço Escovado / IP 44
Aro: 170mm
Furo: 160mm
Altura: 13mm
Quant. Emb.20 pcs
P.U. 17,90€

SL60011AE-20W-84

4200K, 2070lm, 20W
Aço Escovado / IP 44
Aro: 225mm
Furo: 205mm
Altura: 13mm
Quant. Emb.20 pcs
P.U. 21,70€

Downlight Baixo Perfil Dimável

SL60011AE-5W-82-D

2700K, 690lm, 9W
Aço Escovado / IP 44
P.U. 27,70€

SL60011AE-12W-82-D

2700K, 920lm, 12W
Aço Escovado / IP 44
P.U. 33,50€

SL60011AE-5W-84-D

4200K, 600lm, 9W
Aço Escovado / IP 44
P.U. 27,70€

SL60011AE-12W-84-D

4200K, 1380lm, 12W
Aço Escovado / IP 44
P.U. 33,50€

SL60011AE-9W-82-D

2700K, 690lm, 9W
Aço Escovado / IP 44
P.U. 25,85€

SL60011AE-20W-82-D

2700K, 1500lm, 20W
Aço Escovado / IP 44
P.U. 42,00€

SL60011AE-9W-84-D

4200K, 600lm, 9W
Aço Escovado / IP 44
P.U. 25,85€

SL60011AE-20W-84-D

4200K, 2070lm, 20W
Aço Escovado / IP 44
P.U. 42,00€

Downlight Baixo Perfil Led



SL70011BR-3W-82

2700K, 345lm, 3W
Branco / IP 44
Aro: 85x85mm
Furo 75x75mm
Altura: 13mm
Quant. Emb.50 pcs
P.U. 11,30€



SL70011BR-5W-82

2700K, 400lm, 5W
Branco / IP 44
Aro: 85x85mm
Furo 75x75mm
Altura: 13mm
Quant. Emb.50 pcs
P.U. 12,30€

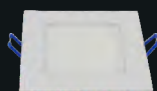

SL70011BR-9W-82

2700K, 690lm, 9W
Branco / IP 44
Aro.: 120x120mm
Furo: 105x105mm
Altura: 13mm
Quant. Emb.50 pcs
P.U. 9,15€



SL70011BR-12W-82

2700K, 1380lm, 12W
Branco / IP 44
Aro: 170x170mm
Furo: 160x160mm
Altura: 13mm
Quant. Emb.20 pcs
P.U. 12,95€

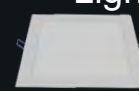

SL70011BR-20W-82

2700K, 2070lm, 20W
Branco / IP 44
Aro: 225x225mm
Furo: 205x205mm
Altura: 13mm
Quant. Emb.20 pcs
P.U. 16,75€

SL70011BR-3W-84

4200K, 345lm, 3W
Branco / IP 44
Aro: 85x85mm
Furo: 75x75mm
Altura: 13mm
Quant. Emb.50 pcs
P.U. 11,30€

SL70011BR-5W-84

4200K, 400lm, 5W
Branco / IP 44
Aro: 85x85mm
Furo: 75x75mm
Altura: 13mm
Quant. Emb.50 pcs
P.U. 12,30€

SL70011BR-9W-84

4200K, 690lm, 9W
Branco / IP 44
Aro.: 120x120mm
Furo: 105x105mm
Altura: 13mm
Quant. Emb.50 pcs
P.U. 9,15€

SL70011BR-12W-84

4200K, 1380lm, 12W
Branco / IP 44
Aro: 170x170mm
Furo: 160x160mm
Altura: 13mm
Quant. Emb.20 pcs
P.U. 12,95€

SL70011BR-20W-84

4200K, 2070lm, 20W
Branco / IP 44
Aro: 225x225mm
Furo: 205x205mm
Altura: 13mm
Quant. Emb.20 pcs
P.U. 16,75€

Downlight Baixo Perfil Dimável

SL70011BR-5W-82-D

2700K, 690lm, 9W
Branco / IP 44
P.U.26,75€

SL70011BR-12W-82-D

2700K, 920lm, 12W
Branco / IP 44
P.U.28,65€

SL70011BR-5W-84-D

4200K, 600lm, 9W
Branco / IP 44
P.U.26,75€

SL70011BR-12W-84-D

4200K, 1380lm, 12W
Branco / IP 44
P.U.28,65€

SL70011BR-9W-82-D

2700K, 690lm, 9W
Branco / IP 44
P.U.23,60€

SL70011BR-20W-82-D

2700K, 1500lm, 20W
Branco / IP 44
P.U.37,00€

SL70011BR-9W-84-D

4200K, 600lm, 9W
Branco / IP 44
P.U.23,60€

SL70011BR-20W-84-D

4200K, 2070lm, 20W
Branco / IP 44
P.U.37,00€



SL70011AE-3W-82

2700K, 345lm, 3W
Aço Escovado / IP 44
Aro: 85x85mm
Furo: 75x75mm
Altura: 13mm
Quant. Emb.50 pcs
P.U.11,70€



SL70011AE-5W-82

2700K, 400lm, 5W
Aço Escovado / IP 44
Aro: 85x85mm
Furo: 75x75mm
Altura: 13mm
Quant. Emb.50 pcs
P.U.13,50€



SL70011AE-9W-82

2700K, 690lm, 9W
Aço Escovado / IP 44
Aro.: 120x120mm
Furo: 105x105mm
Altura: 13mm
Quant. Emb.50 pcs
P.U.12,15€

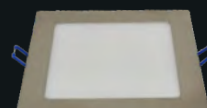

SL70011AE-12W-82

2700K, 1380lm, 12W
Aço Escovado / IP 44
Aro: 170x170mm
Furo: 160x160mm
Altura: 13mm
Quant. Emb.20 pcs
P.U.19,50€

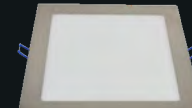

SL70011AE-20W-82

2700K, 2070lm, 20W
Aço Escovado / IP 44
Aro: 225x225mm
Furo: 205x205mm
Altura: 13mm
Quant. Emb.20 pcs
P.U.23,15€

SL70011AE-3W-84

4200K, 345lm, 3W
Aço Escovado / IP 44
Aro: 85x85mm
Furo: 75x75mm
Altura: 13mm
Quant. Emb.50 pcs
P.U.11,70€

SL70011AE-5W-84

4200K, 400lm, 5W
Aço Escovado / IP 44
Aro: 85x85mm
Furo: 75x75mm
Altura: 13mm
Quant. Emb.50 pcs
P.U.13,50€

SL70011AE-9W-84

4200K, 690lm, 9W
Aço Escovado / IP 44
Aro.: 120x120mm
Furo: 105x105mm
Altura: 13mm
Quant. Emb.50 pcs
P.U.12,15€

SL70011AE-12W-84

4200K, 1380lm, 12W
Aço Escovado / IP 44
Aro: 170x170mm
Furo: 160x160mm
Altura: 13mm
Quant. Emb.20 pcs
P.U.19,50€

SL70011AE-20W-84

4200K, 2070lm, 20W
Aço Escovado / IP 44
Aro: 225x225mm
Furo: 205x205mm
Altura: 13mm
Quant. Emb.20 pcs
P.U.23,15€

Downlight Baixo Perfil Dimável

SL70011AE-5W-82-D

2700K, 400lm, 5W
Aço Escovado / IP 44
P.U.30,85€

SL70011AE-12W-82-D

2700K, 920lm, 12W
Aço Escovado / IP 44
P.U.35,00€

SL70011AE-5W-84-D

4200K, 400lm, 5W
Aço Escovado / IP 44
P.U.30,85€

SL70011AE-12W-84-D

4200K, 1380lm, 12W
Aço Escovado / IP 44
P.U.35,00€

SL70011AE-9W-82-D

2700K, 690lm, 9W
Aço Escovado / IP 44
P.U.26,65€

SL70011AE-20W-82-D

2700K, 1500lm, 20W
Aço Escovado / IP 44
P.U.43,50€

SL70011AE-9W-84-D

4200K, 600lm, 9W
Aço Escovado / IP 44
P.U.26,65€

SL70011AE-20W-84-D

4200K, 2070lm, 20W
Aço Escovado / IP 44
P.U.43,50€



SL 50010BR

Aro Fixo Red. Zamak Branco / IP 20
Aro: 78mm
Furo: 65mm
Altura: 24mm
Quant. Emb.100 pcs
P.U. 2,70€



SL 50010CR

Aro Fixo Red. Zamak Aço Escovado / IP 20
Aro: 78mm
Furo: 65mm
Altura: 24mm
Quant. Emb.100 pcs
P.U. 3,38€



SL 50010DR

Aro Fixo Red. Zamak Ouro Velho / IP 20
Aro: 78mm
Furo: 65mm
Altura: 24mm
Quant. Emb.100 pcs
P.U. 3,40€



SL 50020BR

Aro Orient. Red.Zamak Branco / IP 20
Aro: 83mm
Furo: 72mm
Altura: 22mm
Quant. Emb.100 pcs
P.U. 4,30€



SL 50020CR

Aro Orient.Red.Zamak Aço Escovado / IP 20
Aro: 83mm
Furo: 72mm
Altura: 22mm
Quant. Emb.100 pcs
P.U. 5,20€



SL 50020DR

Aro Orient. Red.Zamak Ouro Velho / IP 20
Aro: 83mm
Furo: 72mm
Altura: 22mm
Quant. Emb.100 pcs
P.U. 5,25€



SL 50021BR

Aro Orient.Red.Zamak Branco / IP 20
Aro: 92mm
Furo: 72mm
Altura: 22mm
Quant. Emb.100 pcs
P.U. 4,65€



SL 50021AE

Aro Orient.Red.Zamak Aço Escovado / IP 20
Aro: 92mm
Furo: 72mm
Altura: 22mm
Quant. Emb.100 pcs
P.U. 5,57€



SL 50030BR

Aro Fixo Quad. Zamak Branco / IP 20
Aro: 77x77mm
Furo: 65mm
Altura: 22mm
Quant. Emb.100 pcs
P.U. 2,86€



SL 50030CR

Aro Fixo Quad.Zamak Aço Escovado / IP 20
Aro: 77x77mm
Furo: 65mm
Altura: 22mm
Quant. Emb.100 pcs
P.U. 3,56€



SL 50040BR

Aro Orient.Quad.Zamak Branco / IP 20
Aro: 83x83mm
Furo: 72mm
Altura: 23mm
Quant. Emb.100 pcs
P.U. 4,58€



SL 50040CR

Aro Orient.Quad.Zamak Aço Escovado / IP 20
Aro: 83x83mm
Furo: 72mm
Altura: 22mm
Quant. Emb.100 pcs
P.U. 5,56€



SL 50081-1

Aro Orient.Red.Zamak Alumínio / IP 20
Aro: 92mm
Furo: 80mm
Altura: 26mm
Quant. Emb.50 pcs
P.U. 14,10€



SL 50081-1WH

Aro Orient.Red.Zamak Branco / IP 20
Aro: 92mm
Furo: 80mm
Altura: 26mm
Quant. Emb.50 pcs
P.U. 13,80€

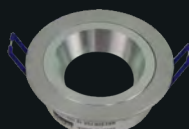

SL 50081-A-AL

Aro Fixo Red. Zamak Alumínio / IP 20
Aro: 92mm
Furo: 80mm
Altura: 26mm
Quant. Emb.50 pcs
P.U. 15,26€



SL 50080-1

Aro Orient.Quad.Zamak Alumínio / IP 20
Aro: 92mm
Furo: 80mm
Altura: 26mm
Quant. Emb.50 pcs
P.U. 14,21€



SL 50080-1WH

Aro Orient.Quad.Zamak Branco / IP 20
Aro: 92mm
Furo: 80mm
Altura: 26mm
Quant. Emb.50 pcs
P.U. 13,80€



SL 50080-2

Aro Orient.Quad.Zamak Alumínio / IP 20
Aro: 174x92mm
Furo: 155x82mm
Altura: 26mm
Quant. Emb.20 pcs
P.U. 28,30€

Aros



SL 50080-3

Aro Orient. Quad. Zamak
Alumínio / IP 20
Aro: 253x92mm
Furo: 235x80mm
Altura: 26mm
Quant. Emb. 20 pcs
P.U. 42,10€

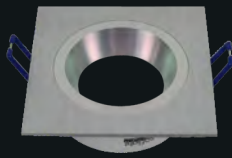

SL50080A-AL

Aro Fixo s/ Vidro
Alumínio / IP 20
Aro: 92mm
Furo: 80mm
Altura: 26mm
Quant. Emb. 50 pcs
P.U. 13,80€



SL 50091-WH

Aro Orient. Red. Zamak
Branco / IP 20
Aro: 92mm
Furo: 78mm
Altura: 40mm
Quant. Emb. 50 pcs
P.U. 15,26€



SL 50091-AL

Aro Orient. Red. Zamak
Alumínio / IP 20
Aro: 92mm
Furo: 78mm
Altura: 40mm
Quant. Emb. 50 pcs
P.U. 15,53€



SL 50091-1WH

Aro Orientável
Branco / IP 20
Aro: 90x90mm
Furo: 78mm
Altura: 40mm
Quant. Emb. 50 pcs
P.U. 15,80€

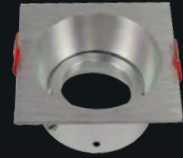

SL 50091-1AL

Aro Orientável
Alumínio / IP 20
Aro: 90x90mm
Furo: 78mm
Altura: 40mm
Quant. Emb. 50 pcs
P.U. 16,10€



SL 50092-AL

Aro Red. c/Vidro Zamak
Alumínio / IP 65
Aro: 83mm
Furo: 65mm
Altura: 30mm
Quant. Emb. 100 pcs
P.U. 11,50€



SL 50092-SN

Aro Red. c/Vidro Zamak
Aço escovado / IP 65
Aro: 83mm
Furo: 65mm
Altura: 30mm
Quant. Emb. 100 pcs
P.U. 12,00€



SL 50092-WH

Aro Red. c/Vidro Zamak
Branco / IP 65
Aro: 83mm
Furo: 65mm
Altura: 30mm
Quant. Emb. 100 pcs
P.U. 11,10€



SL 50093-AL

Aro Quad. c/Vid. Zamak
Alumínio / IP 65
Aro: 83x83mm
Furo: 65mm
Altura: 30mm
Quant. Emb. 100 pcs
P.U. 12,00€



SL 50093-SN

Aro Quad. c/Vid. Zamak
Aço Escovado / IP 65
Aro: 83x83mm
Furo: 65mm
Altura: 30mm
Quant. Emb. 100 pcs
P.U. 12,63€



SL 50093-WH

Aro Quad. c/Vid. Zamak
Branco / IP 65
Aro: 83x83mm
Furo: 65mm
Altura: 30mm
Quant. Emb. 100 pcs
P.U. 11,80€



SL50080-WH.S

Projetor Quad. Saliente
Branco / IP 20
Aro: 95x95mm
Altura: 90mm
Quant. Emb. 20 pcs
P.U. 27,90€

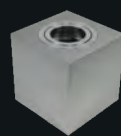

SL50080-AL.S

Projetor Quad. Saliente
Alumínio / IP 20
Aro: 95x95mm
Altura: 90mm
Quant. Emb. 20 pcs
P.U. 30,00€



SL50081-WH.S

Projetor Red. Saliente
Branco / IP 20
Aro: 95mm
Altura: 90mm
Quant. Emb. 20 pcs
P.U. 25,80€



SL50081-AL.S

Projetor Red. Saliente
Alumínio / IP 20
Aro: 95mm
Altura: 90mm
Quant. Emb. 20 pcs
P.U. 27,90€



SL50060-GU10

Projetor c/ Vidro
Aço Escovado / IP 40
Aro: 90x90mm
Furo: 80x80mm
Altura: 120mm
Quant. Emb. 50 pcs
P.U. 13,15€



SL50070-GU10

Projetor s/ Vidro
Aço Escovado / IP 20
Aro: 90x90mm
Furo: 84x84mm
Altura: 140mm
Quant. Emb. 50 pcs
P.U. 12,10€



SL 50082-AL

Projetor Redondo
Alumínio / IP 65
Aro: 94mm
Furo: 65mm
Altura: 26mm
Quant. Emb. 100 pcs
P.U. 14,42€



SL 50083-AL

Projetor Quadrado
Alumínio / IP 65
Aro: 95x95mm
Furo: 65x65mm
Altura: 26mm
Quant. Emb. 100 pcs
P.U. 14,95€



SL 50090BR-GU10

Projetor c/ Vidro
Branco / IP 65
Aro: 100mm
Furo: 80mm
Altura: 95mm
Quant. Emb. 50 pcs
P.U. 13,90€



SL 50090CR-GU10

Projetor c/ Vidro
Aço Escovado / IP 65
Aro: 100mm
Furo: 80mm
Altura: 95mm
Quant. Emb. 50 pcs
P.U. 15,26€



SL 50086-11

Aro Simples Redondo
Alumínio / IP 20
Aro: 178mm
Furo: 150mm
Altura: 30mm
Quant. Emb.10 pcs
P.U. 9,40€



SL 50086-1

Aro Simples Quadrado
Alumínio / IP 20
Aro: 180x180mm
Furo: 150mm
Altura: 25mm
Quant. Emb.10 pcs
P.U. 9,40€



SL 50086-2

Aro Duplo
Alumínio / IP 20
Aro: 340x180mm
Furo: 310x150mm
Altura: 25mm
Quant. Emb.10 pcs
P.U. 18,75€



SL 50086-3

Aro Triplo
Alumínio / IP 20
Aro: 495x180mm
Furo: 465x150mm
Altura: 25mm
Quant. Emb.5 pcs
P.U. 29,30€



SL 50086-4

Aro Quadruplo
Alumínio / IP 20
Aro: 340x360mm
Furo: 310x330mm
Altura: 25mm
Quant. Emb.5 pcs
P.U. 37,50€



SL 50086-AR111

Acessório p/ AR111
Alumínio / IP 20
Aro: 140mm
Altura: 60mm
Quant. Emb.50 pcs
P.U. 11,80€



SL 50086-PAR30

Acessório p/PAR30
Alumínio / IP 20
Aro: 140mm
Altura: 140mm
P.U. 15,30€



SL 90010

Suporte com Fio GU 5,3
Quant. Emb: 1000
P.U. 0,24€



SL 90020

Suporte com Fio GU 10
Quant. Emb.: 100/1000
P.U. 0,47€



SL 90030

Suporte com Fio GU 10
com Chapa Classe II
Quant. Emb.: 200
P.U. 1,88€



SL 90050

Suporte com Fio GU 10
com Ligador Repicagem
Quant. Emb.: 200
P.U. 2,30€

Sensores de Movimento



SL-S20011

Detetor de Movimento
220-240Vac - 180° - IP 44
Distância Max. Detecção 12Mts
Luz Ambiente: 3 a 2000 Lux
Altura Instalação: 1,5 a 2,5 mts
P.U. 13,30€



SL-S20015

Detetor de Movimento
220-240Vac - 180° - IP 65
Distância Max. Detecção 12Mts
Luz Ambiente: 3 a 2000 Lux
Altura Instalação: 1,8 a 2,5 mts
P.U. 15,80€

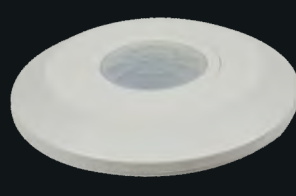

SL-S20005

Detetor de Movimento
220-240Vac - 360° - IP 20
Distância Max. Detecção 12Mts
Luz Ambiente: 3 a 2000 Lux
Alt. Instalação: 2,2 a 4 mts
P.U. 13,30€



SL-S20040

Detetor de Movimento
220-240Vac - 360° - IP 20
Distancia Max. Detecção 12Mts
Luz Ambiente: 3 a 2000 Lux
Alt. Instalação: 2,2 a 4 mts
P.U. 16,90€



SL-S20072

Aplique Muro com Sensor
220-240Vac - 6000K - IP54
10W-800lm
Ajustável 3-2000 lux
Dist. Detecção Max. 9 mts
Inst. Altura 1,8 - 2,5 mts
P.U. 25,90€



SL-S20053

Aplique Muro com Sensor
220-240Vac - 6000K - IP54
10W-800lm
Ajustável 3-2000 lux
Dist. Detecção Max. 9 mts
Inst. Altura 1,8 - 2,5 mts
P.U. 33,20€



ZM-12017

Sensor Movimento
180° / 5-480s
8mts / 1100W / IP 40
Aro: 80x80mm
Altura: 50mm
Quant. Emb.70 pcs
P.U. 13,50€



ZM-12085

Conjunto 3 Tom.c/ com.
Quant. Emb.40 pcs
P.U. 28,00€

Apliques IP 65 LED / GU10



SL-1814-84-BK

Aplique Parede Orientável
Alumínio: Cor Preto
Difusor: PC
LED CREE 1x7W
IP 65 - 4000K
P.U. 110,00€

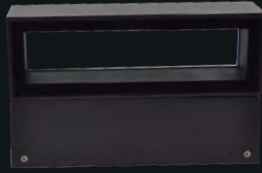

SL-1814-84-WH

Aplique Parede Orientável
Alumínio: Cor Branco
Difusor: PC
LED CREE 1X7W
IP 65 - 4000K
P.U. 110,00€

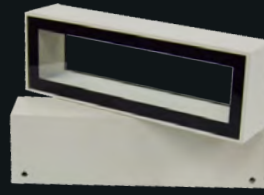

SL-1882-84-BK

Aplique Parede
Alumínio: Cor Preto
Difusor: PC
LED CREE 1x6W
IP 65 - 4000K
P.U. 80,00€

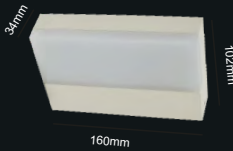

SL-1882-84-WH

Aplique Parede
Alumínio: Cor Branco
Difusor: PC
LED CREE 1x6W
IP 65 - 4000K
P.U. 80,00€



SL-1951-BK

Aplique Parede
Alumínio: Cor Preto
Difusor: PC
2xGU 10 sem Lâmpada
IP 65
P.U. 51,00€



SL-1951-WH

Aplique Parede
Alumínio: Cor Branco
Difusor: PC
2xGU 10 sem Lâmpada
IP 65
P.U. 51,00€



SL-1961-BK

Aplique Parede
Alumínio: Cor Preto
Difusor: PC
2xGU 10 sem Lâmpada
IP 65
P.U. 51,00€



SL-1961-WH

Aplique Parede
Alumínio: Cor Branco
Difusor: PC
2xGU 10 sem Lâmpada
IP 65
P.U. 51,00€





SL-UFO-150W-54-PRO

Campânula UFO Led 150W
100-300Vac - 50/60hz - 120°
19500lm - 6500K - 30000h
Uso Diário Aconselhável 12h
P.U. 140,00€

Campânula UFO (2 Anos Garantia)



SL-UFO-200W-54-PRO

Campânula UFO Led 200W
100-300Vac - 50/60hz - 120°
26000lm - 6500K - 30000h
Uso Diário Aconselhável 12h
P.U. 183,00€

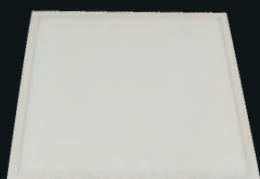

SL-P60X60-40W-84

Painel Led 595x595mm
100-277Vac - 4000K
40W - 4000lm SMD 4014
Quant. Caixa: 1
P.U. 56,00€

Painéis Led 40W (2 Anos Garantia)

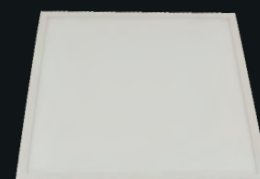

SL-P60X60-40W-54

Painel Led 595x595mm
100-277Vac - 6000K
40W - 4000lm SMD 4014
Quant. Caixa: 1
P.U. 56,00€

Projetores em Led Slim

Projetores em Led Slim Série ECO 1 Ano Garantia

SL-FL-10W-54-ECO

Projetor Led Slim 10W
 220Vac - 6000K
 Uso diário Max. 8h
 IP 65 - 1100lm
 Quant. Cx: 40pcs
P.U. 6,30€

SL-FL-20W-54-ECO

Projetor Led Slim 20W
 220Vac - 6000K
 Uso diário Max. 8h
 IP 65 - 2200lm
 Quant. Cx: 20pcs
P.U. 11,80€

SL-FL-30W-54-ECO

Projetor Led Slim 30W
 220Vac - 6000K
 Uso diário Max. 8h
 IP 65 - 3300lm
 Quant. Cx: 20pcs
P.U. 17,70€

SL-FL-50W-54-ECO

Projetor Led Slim 50W
 220Vac - 6000K
 Uso diário Max. 8h
 IP 65 - 5500lm
 Quant. Cx: 20pcs
P.U. 23,90€

Projetores em Led Slim Série PRO 3 Anos Garantia Led OSRAM

SL-FL-20W-54-PRO

Projetor Led Slim 20W
 220Vac - 6000K
 IP 65 - 2300lm
 Quant. Cx: 50pcs
P.U. 21,40€

SL-FL-30W-54-PRO

Projetor Led Slim 30W
 220Vac - 6000K
 IP 65 - 3450lm
 Quant. Cx: 20pcs
P.U. 28,850€

SL-FL-50W-54-PRO

Projetor Led Slim 50W
 220Vac - 6000K
 IP 65 - 5750lm
 Quant. Cx: 20pcs
P.U. 44,50€

SL-FL-100W-54-PRO

Projetor Led Slim 100W
 220Vac - 6000K
 IP 65 - 11500lm
 Quant. Cx: 10pcs
P.U. 77,700€

SL-FL-20W-84-PRO

Projetor Led Slim 20W
 220Vac - 4000K
 IP 65 - 2300lm
 Quant. Cx: 50pcs
P.U. 21,40€

SL-FL-30W-84-PRO

Projetor Led Slim 30W
 220Vac - 4000K
 IP 65 - 3450lm
 Quant. Cx: 20pcs
P.U. 28,85€

SL-FL-50W-84-PRO

Projetor Led Slim 50W
 220Vac - 4000K
 IP 65 - 5750lm
 Quant. Cx: 20pcs
P.U. 44,50€

SL-FL-150W-54-PRO

Projetor Led Slim 150W
 220Vac - 6000K
 IP 65 - 17250lm
 Quant. Cx: 4pcs
P.U. 124,00€

Projetores em Led Slim Série-S PRO c/Sensor Movimento 2 Anos Garantia Led OSRAM

SL-FL-200W-54-PRO

Projetor Led Slim 200W
 220Vac - 6000K
 IP 65 - 23000lm
 Quant. Cx: 4pcs
P.U. 150,00€

SL-FL-20W-54-S-PRO

Projetor Led Slim 20W
 220Vac - 6000K
 IP 65 - 2300lm
 Quant. Cx: 20pcs
P.U. 41,30€

SL-FL-30W-54-S-PRO

Projetor Led Slim 30W
 220Vac - 6000K
 IP 65 - 3450lm
 Quant. Cx: 25pcs
P.U. 49,15€

SL-FL-50W-54-S-PRO

Projetor Led Slim 50W
 220Vac - 6000K
 IP 65 - 5750lm
 Quant. Cx: 10pcs
P.U. 70,20€



Projetores Chão Led (sem Driver)

Led **CREE**

soflight[®]
Lighting



SL040001-01-82

Proj. Policarbonado, Led
IP 67 - 120°
2700K / 0,3W / 12Vdc
Aro: 30mm
Furo: 25mm
Altura: 32mm
Quant. Emb.50 pcs
P.U. 17,00€



SL040001-01-84

Proj. Policarbonado, Led
IP 67 - 120°
4200K / 0,3W / 12Vdc
Aro: 30mm
Furo: 25mm
Altura: 32mm
Quant. Emb.50 pcs
P.U. 17,00€



SL040001-02-82

Proj. Policarbonado, Led
IP 67 - 120°
2700K / 0,3W / 12Vdc
Aro: 40mm
Furo: 30mm
Altura: 32mm
Quant. Emb.50 pcs
P.U. 23,80€



SL040001-02-84

Proj. Policarbonado, Led
IP 67 - 120°
4200K / 0,3W / 12Vdc
Aro: 40mm
Furo: 30mm
Altura: 32mm
Quant. Emb.50 pcs
P.U. 23,80€



SL040002-01-82

Projektor Inox 316 Led
IP 68 - 38°
2700K / 0,6W / 12Vdc
Aro: 30mm
Furo: 25mm
Altura: 27mm
Quant. Emb.50 pcs
P.U. 31,50€



SL040002-01-84

Projektor Inox 316 Led
IP 68 - 38°
4200K / 0,6W / 12Vdc
Aro: 30mm
Furo: 25mm
Altura: 27mm
Quant. Emb.50 pcs
P.U. 31,50€



SL040004-01-82

Projektor Inox 316 Led
IP 68 - 120°
2700K / 1W / 12Vdc
Aro: 35mm
Furo: 28mm
Altura: 32mm
Quant. Emb.50 pcs
P.U. 37,00€



SL040004-01-84

Projektor Inox 316 Led
IP 68 - 120°
4200K / 1W / 12Vdc
Aro: 35mm
Furo: 28mm
Altura: 32mm
Quant. Emb.50 pcs
P.U. 37,00€

Projetores Chão Led (sem Driver)



SL040002-02-82

Projetor Inox 316 Led
IP 68 - 38°
2700K / 2,5W / 12Vdc
Aro: 45mm
Furo: 36mm
Altura: 54mm
Quant. Emb.50 pcs
P.U. 80,00€



SL040002-02-84

Projetor Inox 316 Led
IP 68 - 38°
4200K / 2,5W / 12Vdc
Aro: 45mm
Furo: 36mm
Altura: 54mm
Quant. Emb.50 pcs
P.U. 80,00€



SL040002-02-RGB

Projetor Inox 316 Led
IP 68 - 38°
RGB/2,5W/12Vdc
Aro: 45mm
Furo: 36mm
Altura: 54mm
Quant. Emb.50 pcs
P.U. 113,00€



SL040003-01-82

Projetor Inox 316 Led
1 Direção / IP 68
2700K/40°/1,2W/12Vdc
Aro: 45mm
Furo: 36mm
Altura: 54mm
Quant. Emb.50 pcs
P.U. 66,00€



SL040003-01-84

Projetor Inox 316 Led
1 Direção / IP 68
4200K/40°/1,2W/12Vdc
Aro: 45mm
Furo: 36mm
Altura: 54mm
Quant. Emb.50 pcs
P.U. 66,00€



SL040003-02-82

Projetor Inox 316 Led
2 Direções / IP 68
2700K/40°/2,5W/12Vdc
Aro: 45mm
Furo: 36mm
Altura: 54mm
Quant. Emb.50 pcs
P.U. 87,00€



SL040003-02-84

Projetor Inox 316 Led
2 Direções / IP 68
4200K/40°/2,5W/12Vdc
Aro: 45mm
Furo: 36mm
Altura: 54mm
Quant. Emb.50 pcs
P.U. 87,00€



SL040005-01-82

Projetor Inox 316 Led
2 Vias - IP 67
2700K / 1,5W / 12Vdc
Diam: 86mm
Altura: 18mm
Com. Cabo: 50cm
Quant. emb. 100 pcs
P.U. 91,00€



SL040006-01-82

Projetor Inox 316 Led
4 Vias - IP 67
2700K / 1,5W / 12Vdc
Diam: 86mm
Altura: 18mm
Com. Cabo: 50cm
Quant. emb. 100 pcs
P.U. 91,00€

SL040005-01-84

Projetor Inox 316 Led
2 Vias - IP 67
4200K / 1,5W / 12Vdc
Diam: 86mm
Altura: 18mm
Com. Cabo: 50cm
Quant. emb. 100 pcs
P.U. 91,00€

SL040006-01-84

Projetor Inox 316 Led
4 Vias - IP 67
4200K / 1,5W / 12Vdc
Diam: 86mm
Altura: 18mm
Com. Cabo: 50cm
Quant. emb. 100 pcs
P.U. 91,00€

Projetores p/ DECK Led, INOX 316



Fita Led Série ECO (1 Ano Garantia)

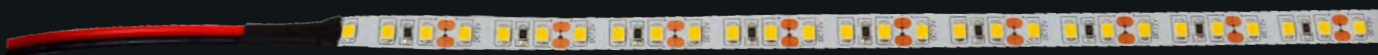

SL-F01020-84-ECO

Rolo Fita Led com
Corrente Constante 12Vdc
Com 120 Led 2835-4000K
Pcb 10mm - 9,6W/mt
Uso diário Max. 8 Horas
Quant. Mt / Rolo: 5mts
P.U. 18,50€

SL-F01020-54-ECO

Rolo Fita Led com
Corrente Constante 12Vdc
Com 120 Led 2835-6000K
Pcb 10mm - 9,6W/mt
Uso diário Max. 8 Horas
Quant. Mt / Rolo: 5mts
P.U. 18,50€

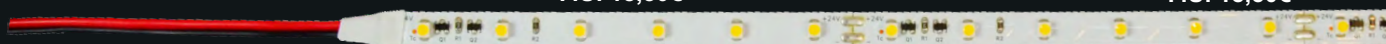

Fita Led Série PRO (5 Anos Garantia)

SL-F01010-82-PRO

Rolo Fita Led com
Corrente Constante 24Vdc
Com 60 Led 2835
Pcb 8mm - 4,8W/mt
3000K
Quant. Mt / Rolo: 10mts
P.U. 74,00€

SL-F01010-84-PRO

Rolo Fita Led com
Corrente Constante 24Vdc
Com 60 Led 2835
Pcb 8mm - 4,8W/mt
4000K
Quant. Mt / Rolo: 10mts
P.U. 74,00€

SL-F01010-54-PRO

Rolo Fita Led com
Corrente Constante 24Vdc
Com 60 Led 2835
Pcb 8mm - 4,8W/mt
6000K
Quant. Mt / Rolo: 10mts
P.U. 74,00€

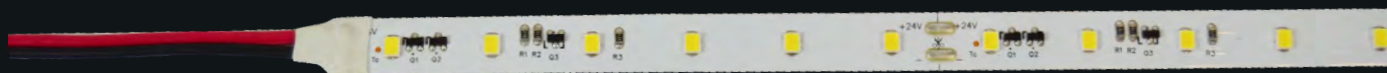

SL-F01020-82-PRO

Rolo Fita Led com
Corrente Constante 24Vdc
Com 60 Led 2835-3000K
Pcb 10mm - 11,5W/mt
Quant. Mt / Rolo: 10mts
P.U. 103,30€

SL-F01020-54-PRO

Rolo Fita Led com
Corrente Constante 24Vdc
Com 60 Led 2835-3000K
Pcb 10mm - 11,5W/mt
Quant. Mt / Rolo: 10mts
P.U. 103,30€



SL-F01050-82/54-PRO

Rolo Fita Led com
Corrente Constante 24Vdc
Com 120 Led 2216
Pcb 8mm - 10W/mt
3000K+6000K
Quant. Mt / Rolo: 5mts
P.U. 56,00€

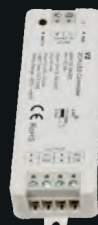

SL-CONTROL-W/WW

Controlador para fita Led
Para Fita W/WW

P.U. 43,00€



SL - CONTROL-01

Controlador
RGB - 1A / Canal
3A
P.U. 30.00€



SL - CONTROL-02

Controlador
RGB - 6A / Canal
18A
P.U. 71.00€



SL - CONTROL-03

Controlador
RGB - 10A / Canal
30A
P.U. 101.00€



SL - AMPLIFIER

Amplificador RGD
12Vdc / IP 20
12A
P.U. 55.00€

Fitas Led (válido para Stock existente)

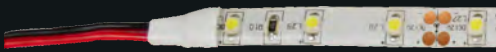

SL - FITA-10W

Rolo (5mts) Fita 60Led
4,8W / mt / 6400K
107 lm/mt/IP 63/12Vdc
P.U. 31.00€

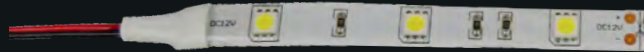

SL - FITA-10WW

Rolo (5mts) Fita 60Led
4,8W / mt / 2700K
107 lm/mt/IP63/12Vdc
P.U. 31.00€

SL - FITA-20W

Rolo (5mts) Fita 30Led
7,2W / mt / 6400K
215 lm/mt/IP 63/12Vdc
P.U. 53.30€

SL - FITA-20WW

Rolo (5mts) Fita 30Led
7,2W / mt / 2700K
215 lm/mt/IP 63/12Vdc
P.U. 53.30€

SL-FITA-20RGB

Rolo (5mts) Fita 30Led
7,2W / mt / RGB
215 lm/mt/IP 63/12Vdc
P.U. 53.30€



SL - FITA-30W

Rolo (5mts) Fita 60Led
14,4W / mt / 6400K
265 lm/mt/IP 63/12Vdc
P.U. 88.90€

SL - FITA-30WW

Rolo (5mts) Fita 60Led
14,4W / mt / 2700K
265 lm/mt/IP 63/12Vdc
P.U. 88.90€

SL - FITA-30-RGB

Rolo (5mts) Fita 60Led
14,4W / mt / RGB
265 lm/mt/IP 63/12Vdc
P.U. 88.90€

SL - FITA-11W

Rolo (5mts) Fita 60Led
4,8W / mt / 6400K
107 lm/mt/IP 20/12Vdc
P.U. 8.90€

SL - FITA-11WW

Rolo (5mts) Fita 60Led
4,8W / mt / 2700K
107 lm/mt/IP 20/12Vdc
P.U. 8.90€

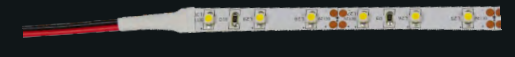

SL - FITA-21W

Rolo (5mts) Fita 30Led
7,2W / mt / 6400K
215 lm/mt/IP 20/12Vdc
P.U. 10.10€

SL - FITA-21WW

Rolo (5mts) Fita 30Led
7,2W / mt / 2700K
215 lm/mt/IP 20/12Vdc
P.U. 10.10€

SL-FITA-21-RGB

Rolo (5mts) Fita 30Led
7,2W / mt / RGB
215 lm/mt /IP 20/12Vdc
P.U. 10.10€

SL - FITA-31W

Rolo (5mts) Fita 60Led
14,4W / mt / 6400K
255 lm/mt/IP 20/12Vdc
P.U. 10.10€

SL - FITA-31-RGB

Rolo (5mts) Fita 60Led
14,4W / mt / RGB
215 lm/mt/IP 20/12Vdc
P.U. 10.10€



SL - FITA-BR04

Rolo (5mts) Fita 60Led
107 lm/mtIP65/12Vdc

Rolo (5mts) Fita 60Led
4,8W / mt / 2700K
107 lm/mtIP65/12Vdc
P.U. 23.00€

SL - FITA-RGB01

Rolo (5mts) Fita 30Led
7,2W / mt / RGB
215 lm/mtIP65/12Vdc
P.U. 23.00€

SL - FITA-100-10WW

Barra Led Alumínio 9,6W
2700K / 12Vdc
Dim.1000x11mm
P.U. 13.00€



SL - FITA-050-30W

Barra Led Alumínio 9,6W
6400K / 12Vdc IP 20
Dim.500x12mm
P.U. 9.70€

SL - FITA-050-30WW

Barra Led Alumínio 9,6W
2700K / 12Vdc IP 20
Dim.500x12mm
P.U. 9.70€

SL-FITA-RGB+W

Fita RGB - 6400K
12Vdc / 9,6W / IP 20
P.U. 58.00€

SL-FITA-RGB+WW

Fita RGB-2700K/9,6W
12Vdc / 9,6W / IP 20
P.U. 58.00€



Fitas de Neon

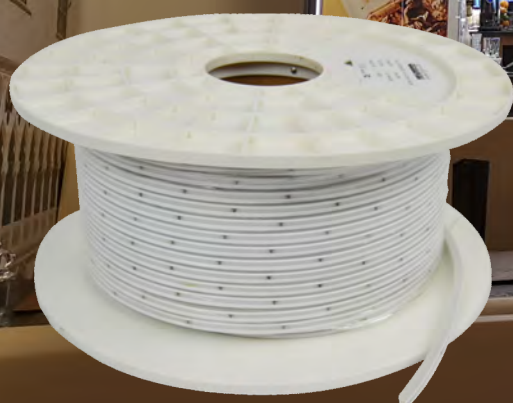

Fita Neon Série PRO (3 Anos Garantia)



8W/lm - 650lm



SL-FN0508-84-PRO

Fita Neon 05x08mm
4000K - 24Vdc
8W/lm - 650lm
IP 65 - Led 2835
Quant. Mt / Rolo: 100mts
P.U. 28,30€/ mt

SL-FN0511-84-PRO

Fita Neon 05x11mm
4000K - 24Vdc
11W/m - 500lm/m
IP 67 - Led 2835
Quant. Mt / Rolo: 100mts
P.U. 22,50€/ mt

SL-FN0812-84-PRO

Fita Neon 08x12mm
4000K - 24Vdc
11W/m - 650lm/m
IP 67 - Led 2835
Quant. Mt / Rolo: 100mts
P.U. 28,50€/ mt

SL-FN1010-84-PRO

Fita Neon 10x10mm
4000K - 24Vdc
11W/m - 900lm/m
IP 67 - Led 2835
Quant. Mt / Rolo: 100mts
P.U. 39,90€/ mt

SL-FN1717-84-PRO

Fita Neon 17x17mm
4000K - 24Vdc
11W/m - 900lm/m
IP 67 - Led 2835
Quant. Mt / Rolo: 100mts
P.U. 43,95€/ mt



SL-TR-01

Transformador, IP 20
100-240Vac / 12Vdc
2,1A / 25W
84x58x38mm
P.U. 14,30€



SL-TR-02

Transformador, IP 20
100-240Vac / 12Vdc
4,16A / 50W
110x78x35mm
P.U. 20,60€

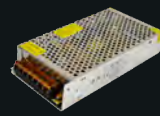

SL-TR-03

Transformador, IP 20
100-240Vac / 12Vdc
8,33A / 100W
159x98x38mm
P.U. 29,90€

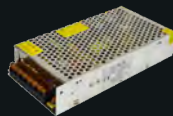

SL-TR-04

Transformador, IP 20
100-240Vac / 12Vdc
12,5A / 150W
198x98x38mm
P.U. 35,80€

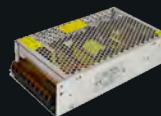

SL-TR-05

Transformador, IP 20
100-240Vac / 12Vdc
20A / 250W
200x110x50mm
P.U. 51,50€

SL-TR-01-24V

Transformador, IP 20
100-240Vac / 24Vdc
1,04A / 25W
84x58x38mm
P.U. 14,30€

SL-TR-02-24V

Transformador, IP 20
100-240Vac / 24Vdc
2,08A / 50W
110x78x35mm
P.U. 20,60€

SL-TR-03-24V

Transformador, IP 20
100-240Vac / 24Vdc
4,16A / 100W
159x98x38mm
P.U. 29,90€

SL-TR-04-24V

Transformador, IP 20
100-240Vac / 24Vdc
6,2A / 150W
198x98x38mm
P.U. 35,80€

SL-TR-05-24V

Transformador, IP 20
100-240Vac / 24Vdc
10A / 250W
200x110x50mm
P.U. 51,50€

Calha 3 Fases Alumínio

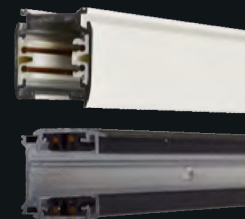
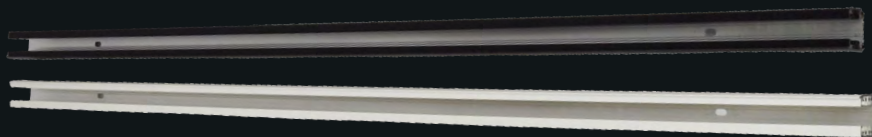

Código	Descrição	Comp.	Larg.	Alt.	Cor	Preço
SL-C410-1WH	Calha 3 Fases	1 mt	35mm	38mm	Branca	39,00€
SL-C410-1BK	Calha 3 Fases	1 mt	35mm	38mm	Preta	39,00€
SL-C410-2WH	Calha 3 Fases	2 mt	35mm	38mm	Branca	78,30€
SL-C410-2BK	Calha 3 Fases	2 mt	35mm	38mm	Preta	78,30€
SL-C410-3WH	Calha 3 Fases	3 mt	35mm	38mm	Branca	117,00€
SL-C410-3BK	Calha 3 Fases	3 mt	35mm	38mm	Preta	117,00€



SL-C440-WH

Adaptador p/ Calha Branco

P.U. 11,60€



SL-C0431-L-WH

Alimentador Esquerdo Branco

P.U. 14,70€



SL-C0431-R-WH

Alimentador Direito Branco

P.U. 14,70€



SL-C0432-WH

Topo Branco

P.U. 8,70€



SL-C0433-WH

União Curta Branco

P.U. 27,00€

SL-C0440-BK

Adaptador p/ Calha Preto

P.U. 11,60€

SL-C0431-L-BK

Alimentador Esquerdo Preto

P.U. 14,70€

SL-C0431-R-BK

Alimentador Direito Preto

P.U. 14,70€

SL-C0432-BK

Topo Preto

P.U. 8,70€

SL-C0433-BK

União Curta Preto

P.U. 27,00€

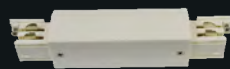

SL-C0434-WH

União / Aliment. Central Branco

P.U. 33,70€



SL-C0435-L-WH

Curva 90° Esquerda Branco

P.U. 27,00€



SL-C0435-R-WH

Curva 90° Direita Branco

P.U. 27,00€



SL-C0436-L1-WH

Derivação «T» Esq. Branco

P.U. 35,00€



SL-C0436-L2-WH

Derivação «T» Esq. Branco

P.U. 35,00€

SL-C0434-BK

União / Aliment. Central Preto

P.U. 33,70€

SL-C0435-L-BK

Curva 90° Esquerda Preto

P.U. 27,00€

SL-C0435-R-BK

Curva 90° Direita Preto

P.U. 27,00€

SL-C0436-L1-BK

Derivação «T» Esq. Preto

P.U. 35,00€

SL-C0436-L2-BK

Derivação «T» Esq. Preto

P.U. 35,00€

Calhas e Acessórios

soflight®
Lighting



SL-C0436-R1-WH

Derivação «T» Direita. Branco

P.U. 35,00€



SL-C0436-R2-WH

Derivação «T» Direita Branco

P.U. 35,00€



SL-C0437-WH

Derivação «+» Direita Branco

P.U. 43,50€



SL-C0447-WH

Suspensão Varão 1mt Branco

P.U. 23,50€



SL-C0448-WH

Susp. Cabo d' aço 1mt Branco

P.U. 13,50€



SL-C0436-R1-BK

Derivação «T» Direita. Preto

P.U. 35,00€



SL-C0436-R2-BK

Derivação «T» Direita Preto

P.U. 35,00€

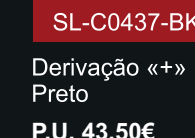

SL-C0437-BK

Derivação «+» Direita Preto

P.U. 43,50€



SL-C0447-BK

Suspensão Varão 1mt Preto

P.U. 23,50€



SL-C0448-BK

Susp. Cabo d' aço 1mt Preto

P.U. 13,50€



SL-C0449-WH

Adaptador Mecânico Branco

P.U. 35,00€



SL-CSK-WH

Suporte Fixação Branco

P.U. 6,50€



SL-CB5002-WH

Caixa Vazia p/Driver Branca

P.U. 40,00€

3 Anos Garantia



SL-C8268-84-WH

Proj.p/Calha, s/Adapt. LED. Branco
4200K/20W/3000lm

P.U. 110,00€



SL-C0449-BK

Adaptador Mecânico Preto

P.U. 35,00€



SL-CSK-BK

Suporte Fixação Preto

P.U. 6,50€



SL-CB5002-BK

Caixa Vazia p/Driver Preta

P.U. 40,00€

1 Ano Garantia



SL-TL-30W-D-WH

Projeter Calha Branco
4000K-38°-30W Led
3000lm
Quant.Embalagem: 1pcs
P.U. 86,20€



SL80011BR

Projeter Simples c/Base
Suporte GU10
Sem Lâmpada
Cor: Branco
P.U. 17,50€



SL80012BR

Projeter Duplo c/Base
Suporte GU10
Sem Lâmpadas
Cor: Branco
P.U. 33,70€



SL80013BR

Projeter Triplo c/Base
Suporte GU10
Sem Lâmpadas
Cor: Branco
P.U. 51,60€



SL-TL-30W-D-BK

Projeter Calha Preto
4000K-38°-30W Led
3000lm
Quant.Embalagem: 1pcs
P.U. 86,20€



SL80011PT

Projeter Simples c/Base
Suporte GU10
Sem Lâmpada
Cor: Preto
P.U. 17,50€



SL80012PT

Projeter Duplo c/Base
Suporte GU10
Sem Lâmpadas
Cor: Preto
P.U. 33,70€



SL80013PT

Projeter Triplo c/Base
Suporte GU10
Sem Lâmpadas
Cor: Preto
P.U. 51,60€

Lâmpada de Led

soflight®
Lighting



SL-GU10-5W-84

Lâmpada GU 10 - 5W
400lm - 4000K
Quant. Caixa: 100pcs
P.U. 2,30€



SL-GU10-7W-54

Lâmpada GU 10 - 7W
520lm 6000K
Quant. Caixa: 100pcs
P.U. 2,65€



SL-GU10-9W-54

Lâmpada GU 10 - 9W
650lm 6000K
Quant. Caixa: 100pcs
P.U. 5,15€



SL-G45-5W-84-E14

Lâmpada G45-5W-E14
400lm 4000K
Quant. Caixa: 100pcs
P.U. 2,25€



SL-G45-7W-84-E14

Lâmpada G45-7W-E14
560lm 4000K
Quant. Caixa: 100pcs
P.U. 2,50€



SL-G45-5W-84-E27

Lâmpada G45-5W-E27
400lm 4000K
Quant. Caixa: 100pcs
P.U. 2,25€



SL-G45-7W-84-E27

Lâmpada G45-7W-E27
400lm 4000K
Quant. Caixa: 100pcs
P.U. 2,45€

SL-G45-5W-54-E14

Lâmpada G45-5W-E14
400lm 6000K
Quant. Caixa: 100pcs
P.U. 2,25€

SL-G45-7W-54-E14

Lâmpada G45-7W-E14
560lm 6000K
Quant. Caixa: 100pcs
P.U. 2,50€

SL-G45-5W-54-E27

Lâmpada G45-5W-E27
400lm 6000K
Quant. Caixa: 100pcs
P.U. 2,25€

SL-G45-7W-54-E27

Lâmpada G45-7W-E27
560lm 6000K
Quant. Caixa: 100pcs
P.U. 2,45€



SL-G9-6W-84

Lâmpada G9-6W
400lm 4000K
Quant. Caixa: 100pcs
P.U. 3,65€



SL-G9-10W-84

Lâmpada G9-10W
700lm 4000K
Quant. Caixa: 100pcs
P.U. 5,50€



SL-C37-5W-84-E14

Lâmpada C37-5W-E14
400lm 4000K
Quant. Caixa: 100pcs
P.U. 2,25€



SL-A60-F-6W-82-E27

Lâmpada A60-6W-E27
600lm 3000K
Quant. Caixa: 100pcs
P.U. 3,85€



SL-C37-5W-54-E14

Lâmpada C37-5W-E14
400lm 6000K
Quant. Caixa: 100pcs
P.U. 2,25€



SL-A60-10W-54-E27

Lâmpada A60-10W-E27
806lm 6000K
Quant. Caixa: 100pcs
P.U. 2,75€

Lâmpadas Descontinuadas, Valido para Stock Existente



GL-05-310-WW

Lâmpada Led E14
3W / 18SMD
2700K

P.U. 2,20€



GL-05-310-W

Lâmpada Led E14
3W / 18SMD
6500k

P.U. 2,20€



GL-05-410-W

Lâmpada Led E27
3W / 48SMD
6000K

P.U. 2,50€



GL-05-410-WW

Lâmpada Led E27
3W / 48SMD
2700K

P.U. 2,50€



GL-05-040W-82

Lâmpada Led GU 10
4W / 36° 2700K
350Lm

P.U. 2,50€



GL-05-060W-82

Lâmpada Led GU 10
6W / 36° 2700K
450Lm

P.U. 2,90€



GL-05-RGB-DMX

Lâmpada Led 5W
RGB 12vDC

P.U. 50,00€



GL-05-09-82

Lâmpada GU10
4,5W
2700K / 410lm

P.U. 2,20€



GL05-SMD24D-82

Lâmpada Led 24 SMD
4,5W 120W 230V
2700K / 410lm

P.U. 1,80€



GL-05-R50-030

Lâmpada Led E14
3W / 6500K
200Lm

P.U. 5,50€



GL-05-R63-045W

Lâmpada Led E27
4,5W / 6500K
300Lm

P.U. 6,85€



GL-05-PAR38-18W

Lâmpada Led PAR 38
18W / 4200K
800Lm

P.U. 32,00€



SL-L-GX53-6W-84

Lâmpada GX 53
6W - 4000K
540lm

P.U. 4,50€



SL-S-GX53

Suporte GX 53

P.U. 1,05€



Guia Nylon

SL-15-GP005 (5mts)
Embalagem: 40 pcs
P.U. 3.10

SL-15-GP010 (10 mts)
Embalagem: 25 pcs
P.U. 6.00€

SL-15-GP015 (15mts)
Embalagem: 20 pcs
P.U. 8.25€

SL-15-GP020 (20mts)
Embalagem: 15 pcs
P.U. 10.00€

SL-15-GP025 (25mts)
Embalagem: 13 pcs
P.U. 12.60€

SL-15-GP030 (30 mts)
Embalagem: 10 pcs
P.U. 15.00€



Guia de Aço

SL-15-GA005 (5mts)
Embalagem: 40 pcs
P.U. 3.60€

SL-15-GA010 (10 mts)
Embalagem: 25 pcs
P.U. 11.20€

SL-15-GA015 (15mts)
Embalagem: 20 pcs
P.U. 16.70€

SL-15-GA025 (25mts)
Embalagem: 13 pcs
P.U. 28.00€

SL-15-GA030 (30 mts)
Embalagem: 10 pcs
P.U. 56.00€



SL - S110-10W-54

Projektor Led 10W.
120° / 6000K / 900lm
Dim.115x88x78mm

P.U 2.25€



SL - S110-20W-82

Projektor Led 20W.
120° / 4000K / 2000lm
Dim.181x140x100mm

P.U 6.70€

SL - S110-10W-82

Projektor Led 10W.
120° / 4000K / 900lm
Dim.115x88x78mm

P.U 2.25€



SL - S110-30W-54

Projektor Led 30W.
120° / 6000K / 3000lm
Dim.225x186x124mm

P.U 10.00€

SL - S110-30W-82

Projektor Led 30W.
120° / 4000K / 3000lm
Dim.225x186x124mm

P.U 10.00€



olympiaTM
electronics
SAFETY & SECURITY SYSTEMS

for a safer world!

Safety & Security Systems





Baixo perfil
Sensor Luz
Auto - Teste

Fácil Instalação
Controlo Remoto
Permanente e Não Permanente



Conjunto de 3
Tampas incluídas



Armadura Emergência SLIM LEDs LIGH™

MODELO	DESCRIÇÃO	PREÇO	IP 20
GR-2000	Permanente/Não- Permanente/LEDs-110/110lm Autonomia 3 a 7 horas	124,00€	
IRT-200	RC-15A IR Controlo Remoto para Armadura GR-2000 (38KHZ)	23,00€	

*GR-2000 Registrado para WIPO No. DM/ 074 490



GR-82/230VA/82NI Não Permanente 3,6V/120mA Led -20lm / 3h 36,00€



GR-82/230VA/82W/SQ Não Permanente Fluorecete 6W - 50lm / 1.5h 36,00€

Armaduras em LEDs "SLIM LEDs LIGHT"

MODELO	DESCRIÇÃO	PREÇO	IP 20
GR-8/Led/R	Perm. / Não perm. / LEDs - 40/100lm / 1.5h	35,00€	
GR-8/2I/R	Não perm. / LEDs - 50lm / 2h	32,00€	
GR-310/12L/90R	Perm. / Não perm. / LEDs - 35/75lm / 1.5h	54,80€	IP 40
GR-310/12L/180R	Perm. / Não perm. / LEDs - 35/75lm / 3h	75,20€	
GR-310/30/L/R	Não perm. / LEDs - 210lm / 1.5h	81,20€	
GR-312/30/L/R	Não perm. / LEDs - 210lm / 3h	170,20€	
GR-315/15/L/R	Permanente / LEDs - 105lm / 1.5h	97,70€	
GR-315/30/L/R	Permanente / LEDs - 210lm / 3h	123,50€	

GR-1935/15L/R	Permente / Não Permanente Led 40/105lm 1.5h IP 65	85,50€	IP 65
GR-935/15/L/R	Não-Permanente / LEDs - 105lm / 1.5h	94,50€	
GR-935/4P/R	Não-Permanente / LEDs - 250lm / 1.5h	180,50€	
GR-938/15L/R	Permanente / LEDs - 105lm / 1.5h	122,50€	
GR-938/30L/R	Permanente / LEDs - 210lm / 1.5h	147,50€	



GR-8/R Não Permanente Fluorecete 6W - 50lm / 1.5h 16,50€



GR-410/R Não Permanente Fluorescente 8W - 85lm / 1.5h 21,80€



GR-4/UN65 Kit emergencia para Lâmpada T5 / T8 1.5h 53,50€

GR-51/A Telecomando até 100 Armaduras Inibit 96,50€



LEDs de alto rendimento
Longa duração do LED (100.000 horas)
Design elegante
Sinais direcção podem ser aplicados p/ utilizador

Fabricado de acordo com: EN 60598-1,
EN60598-2-22, EN 1836
Instalação em tecto falso utilizando base especial
Temperatura de funcionamento: 0 a 40° C



As sinaléticas usam tecnologia amiga do ambiente.

SINALÉTICA (dupla face) com fundo verde e LEDs brancos da série "ECO LIGHT"

95,00€

MODELO	DESCRIÇÃO	DIMENSÕES (CxLxA)	CÓDIGO	PREÇO
MLD-28D/w	Sinalética, permanente / 12 LEDs - 72/72lm, 3h.	283x130x25mm	922502811	95,00€
MLD-28D/w/90	Sinalética, permanente / 12 LEDs - 72/72lm, 90min.	283x130x25mm	922502827	95,00€
MLD-34D/w	Sinalética, permanente / 15 LEDs - 90/90lm, 3h.	343x200x25mm	922503426	186,00€
MLD-44D/w	Sinalética, permanente / 15 LEDs - 90/90lm, 3h.	443x250x25mm	922504417	228,00€

IP 40



SINALÉTICA (dupla face) com fundo transparente e LEDs verdes da série "ECO LIGHT"

MODELO	DESCRIÇÃO	DIMENSÕES (CxLxA)	CÓDIGO	PREÇO
MLD-28S/G/R	Sinalética, permanente / LEDs - 18/18lm / 3h.	283x130x25mm	922502800	128,00€
MLD-28S/G/90/R	Sinalética, permanente / LEDs - 18/18lm / 90min.	283x130x25mm	922502826	92,00€
MLD-34S/G/R	Sinalética, permanente / LEDs - 18/22lm / 3h.	343x200x25mm	922503400	174,00€
MLD-44S/g	Sinalética, permanente / LEDs - 18/22lm / 3h.	443x250x25mm	922504400	207,00€

IP 40



ACESSÓRIOS PARA ARMADURAS "ECO LIGHT" (mediante encomenda)

MODELO	DESCRIÇÃO	CÓDIGO	PREÇO
A-1022	Kit para instalação em tecto para 20 cm distância	927102200	59,00€
A-1025	Kit para instalação em tecto para 40 cm distância	927102500	66,60€
A-1026	Kit para instalação em tecto para 60 cm distância	927102600	91,00€
A-1027	Kit para instalação em tecto com corrente até 50 cm	927102700	9,20€
A-1018	Base de encastrar apropriada para MLD28, DLD 28	980210180	32,20€
A-1020	Base de encastrar apropriada para MLD 34, DLD 34	980210200	41,40€

IP 40



* Acessórios incluídos na embalagem.
apropriados para montagem em tecto
e parede



Foram projectadas para áreas onde é necessário iluminação de alto rendimento ou autonomia máxima.
As lanternas GR-21/H3 são armaduras emergência estanques(IP65), caixa com pintura electrostática, duas lâmpadas de 55W e 3 horas de autonomia

LANTERNA EMERGÊNCIA DE ALTO RENDIMENTO da série "POWER LIGHT"

MODELO	DESCRIÇÃO	CÓDIGO	PREÇO
GR-21/R	Não-permanente/halogéneo 2x20W-700 lm, 90min.	923021000	168,50€
GR-21/H/R	Não-permanente/halogéneo 2x55W-2400 lm, 60min.	923021001	499,50€

IP 42



LANTERNA EMERGÊNCIA ESTANQUE Led

MODELO	DESCRIÇÃO	CÓDIGO	PREÇO
GRL-21/R	Lanterna Emerg.Não-perma./Led 790lm 1m1.5h	923021011	182,50€

IP 42



LANTERNA EMERGÊNCIA ESTANQUE (IP65) DE ALTO RENDIMENTO da série "POWER LIGHT"

MODELO	DESCRIÇÃO	CÓDIGO	PREÇO
GR-32/R	Estanques,não-perma./halogéneo 2x55W-2400 lm, 60min.	923032000	537,50€

IP 65



ELECTROCUTORES DE INSECTOS COM GRELHA ALTA VOLTAGEM



olympiaTM
electronics

SAFETY & SECURITY SYSTEMS

Design moderno
Instalação fácil
Dois modelos portáteis (RT-11, RT-12)
Uma gama completa de modelos profissionais para áreas de grandes dimensões
Modelos especiais com acessório para montagem em parede (RT-14/6, RT-14/7, RT-15/6, RT-15/7).

Gaveta para insectos de limpeza fácil
Luz UV para atrair insectos
Todos os modelos funcionam utilizando tubos de luz negra especial (BL)
Partes plásticas resistentes a UV
Material de fabrico: ABS resistente às chamas, Alumínio pintado electrostaticamente



ELECTROCUTOR DE INSECTOS COM GRELHA DE ALTA VOLTAGEM

MODELO	DESCRIÇÃO	CÓDIGO	PREÇO
RT-11	Electrocutor de insectos - Lâmpada BL 2 x 8W	925011000	153,50€

ELECTROCUTOR DE INSECTOS COM GRELHA DE ALTA VOLTAGEM

MODELO	DESCRIÇÃO	CÓDIGO	PREÇO
RT-12	Electrocutor de insectos - Lâmpada BL 2 x15W	925012000	217,50€
A-1024	Grelha de protecção (transparente) para RT-12	801822012	12,40€



ELECTROCUTOR INSECTOS, GRELHA DE ALTA VOLTAGEM (INSTALAÇÃO EM PAREDE)

MODELO	DESCRIÇÃO	CÓDIGO	PREÇO
RT-14	Electrocutor de insectos - Lâmpada BL 3 x20W	925014000	348,00€
RT-14/2	Electrocutor de insectos - Lâmpada BL 2 x 20W	925014001	328,00€

ELECTROCUTOR DE INSECTOS COM GRELHA ALTA VOLTAGEM

MODELO	DESCRIÇÃO	CÓDIGO	PREÇO
RT-15	Electrocutor insectos - Lâmpada BL 3 x 40W	925015000	564,00€

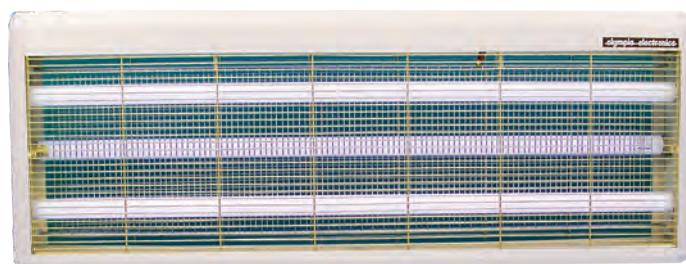

Os electrocutores de insectos são utilizados para exterminar vários insectos incomodativos. Possuem tubos especiais de luz negra utilizados para atrair a distâncias consideráveis. Podem ser utilizados em qualquer área onde existam insectos.

Possuem no interior uma grelha de alta voltagem (2 a 4 KV dependendo do modelo) e uma grelha exterior para protecção de pessoas, animais e pássaros que possam chegar perto. Protegem-nos de vários tipos de insectos (mosquitos, moscas, melgas, etc...) que são atraídos pela luz sem recurso a qualquer tipo de químicos. A gaveta de recolha incorporada pode ser facilmente removida e limpa.



Design moderno.

Amigo do ambiente.

Instalação e limpeza fácil.

Fabrico de acordo c/ os regulamentos HACCP.

Não utiliza grelhas de alta voltagem.

Possibi.colocação em mesa(acessório especial)

Arm.cola,resist. a raios UV,e altas temperaturas

Material fabrico:ABS resistente às chamas,
alumínio pintado electrostaticamente

Produzido de acordo com: EN60335.02.59

UV para atrair insectos

Na indústria da alimentação, restauração e bebidas é obrigatório aderir ao regulamento HACCP, segundo o qual é proibido a utilização de químicos e grelhas de alta voltagem no fabrico de armadilhas para insectos. Em substituição da grelha de alta voltagem, é utilizada uma placa de cola especial. A respectiva legislação do Conselho Europeu é TL/195/97-CE93/43 de 96/3 de 14 de Junho 1993. Esta legislação específica é obrigatória para toda a indústria onde há manuseamento de alimentos, assim como a indústria da restauração (restaurantes, doçarias, confeitarias, padarias, talhos e supermercados, etc)

O produto RT-1 combina a sua utilização para insectos e luz nocturna. A sua luz azul possui uma frequência especial que atrai insectos e possui uma folha especial substituível. A área de alcance é sensivelmente de uma sala.

ARMADILHA DE COLA PARA INSECTOS COM COLA da série "DELUXE FLYTRAP"

MODELO	DESCRIÇÃO	CÓDIGO	PREÇO
RT-30	Armadura de cola - Lâmpada BL 2 x 8W (cobertura 40 sq.m)	925030000	110,40€
RT-30/SL	Arma.de cola - Lâmpada BL 2 x 8W (cobertura 40 sq.m), cinza prata	925030100	128,50€
RT-30/HACCP	Armadura de cola - Lâmpada BL/HACCP 2 x 8W (cobertura 40 sq.m)	925030200	168,50€
RT-30/HACCP/SL	Arma.cola-Lâmp.BL/HACCP 2x8W (cobertura 40 sq.m),cinza prata	925030300	170,00€
RT-36	Armadura de cola - Lâmpada PL 26W BL (cobertura 60 sq.m)	925036000	126,00€
RT-36/SL	Armadura de cola - PL 26W BL (cobertura 60 sq.m), cinza prata	925036100	148,00€



PEÇAS DE SUBSTITUIÇÃO da série "DELUXE FLYTRAP"

MODELO	DESCRIÇÃO	CÓDIGO	PREÇO
A-1030	Grelha para «Deluxe Fly» (para uso externo)	980103000	11,50€
A-1046	Placa de cola para "Deluxe Fly" (6 peças)	927104600	19,50€
A-1048	Placa de cola para "Deluxe Fly" (12 peças)	927104800	34,50€

ARMADILHAS DE COLA PARA INSECTOS da série "FOODY'S FLYTRAP"

MODELO	DESCRIÇÃO	CODIGO	PREÇO
RT-22	Armadilha de cola - Lâmpada BL 2x15W (cobertura 80 sq.m)	925022000	256,00€
RT-22/HACCP	Armadilha de cola - Lâmpada BL/HACCP 2x15W (cobertura 80 sq.m)	925022100	293,00€
RT-24	Armadilha de cola - Lâmpada BL 4x15W (cobertura 160 sq.m)	925024000	291,00€
RT-24/HACCP	Armadilha de cola - Lâmpada BL/HACCP 4x15W(cobertura 160 sq.m)	925024100	375,00€



PEÇAS DE SUBSTITUIÇÃO da série "FOODY'S FLYTRAP"

MODELO	DESCRIÇÃO	CÓDIGO	PREÇO
A-1050	Placa de cola para RT-22 (1 peça)	927105000	11,30€
A-1052	Placa de cola para RT-24 (dupla face)	927105200	13,30€
A-1024	Grelha protecção (transparente) para RT-22 e RT-24	801822012	13,00€

ARMADILHAS DE COLA PARA INSECTOS da série "PROFESSIONAL DELUXE FLYTRAP"

MODELO	DESCRIÇÃO	CÓDIGO	PREÇO
RT-50/HACCP	Armadilha cola - Lâmpada BL/HACCP 1 x 20W (cobertura 80 sq.m)	925050000	246,00€
RT-52/HACCP	Armadilha cola - Lâmpada BL/HACCP 2 x 20W (cobertura 160 sq.m)	925052000	430,00€
RT-60/HACCP	Armadilha cola - Lâmpada BL/HACCP 1 x 40W (cobertura 180 sq.m)	925060000	348,00€
RT-62/HACCP	Armadilha cola- Lâmpada BL/HACCP 2 x 40W (cobertura 360 sq.m)	925062000	635,00€



PEÇAS DE SUBSTITUIÇÃO da série "PROFESSIONAL DELUXE FLYTRAP"

MODELO	DESCRIÇÃO	CÓDIGO	PREÇO
A-1066	Placa de cola para "Deluxe Fly" (6 peças)	927106600	39,00€
A-1068	Placa de cola para "Deluxe Fly" (12 peças)	927106800	70,00€

BS-1632, BS-1634, BS-1636. Painéis de detecção de incêndio com 2,4 e 6 zonas respectivamente. Possuem controlos e indicações de funcionamento uniformes. Possuem 2 saídas para sirenes, relé de alarme, saída para operador telefónico e um relé por zona.

BS-1610. Painel de detecção de incêndio de 10 zonas com o mesmo funcionamento e indicações dos painéis anteriores. Oferecem 2 saídas para sirenes, um relé de alarme, saída de falha e 2 relés independentes respectivamente.

BS-633. Painel de detecção de incêndio com 2 zonas para sensores, uma zona para botoneira, uma saída para sirene e uma saída para extintor de incêndio com atraso programável (adequados para postos de gasolina).

Para funcionamento dos painéis é necessário uma bateria A-986 (12V/7Ah). Todas as funções e indicações estão de acordo com a norma europeia EN 54.

BS-1634/EXT. Painel de detecção de incêndio com 2 zonas, uma zona detecção de gás e extinção manual, adequados para zonas comerciais.

BS-1628-1. 2 Painel extinção de zona, com zona para cancelamento manual de extinção. A saída de extinção é controlável e pode ser usada uma botoneira ou uma electroválvula. Além disso possui uma saída para sirene, uma para erro, 1 saída para painel de detecção de incêndio.



PAINÉIS DE DETEÇÃO DE INCÊNDIO COM 2,3,4,6 E 10 ZONAS da série "FIRE SYS"

MODELO	DESCRIÇÃO	PREÇO
BS-1632	Painel de detecção de incêndio com relé independente por zona e relé AUX	319,50€
BS-1633	Painel de detecção de incêndio de zonas (para postos de gasolina)	421,50€
BS-1634	Painel de detecção de incêndio de 4 zonas c/relé independente por zona e relé AUXy	336,00€
BS-1634/EXT	Painel de detecção de incêndio de 4 zonas, 1 saída extintor (zona passagem)	446,00€
*BS-1636	Painel de detecção de incêndio de 6 zonas c/relé independente por zona e relé AUX	434,00€
BS-1610	Painel de detecção de incêndio de 10 zonas	738,00€



PAINÉIS EXTINÇÃO DE INCÊNDIO

MODELO	DESCRIÇÃO	CÓDIGO	PREÇO
BS-627	Painel de extinção de incêndio com comando de 4 zonas	921627000	1220,00€
BS-628-1	Painel de extinção, com uma zona de cancelamento manual de extinção	921628001	247,00€



BS-50

PERIFÉRICOS DE DETEÇÃO DE INCÊNDIO - ACESSÓRIOS da série "FIRE SYS"

MODELO	DESCRIÇÃO	CÓDIGO	PREÇO
BS-613	Carta com 4 relés de zona para painel BS-610	921613000	68,00€
BS-620	Unidade de aviso público	921620000	191,00€
BS-50	Microfone para BS-620	921050000	68,00€
A-632	Base metálica de encastrar para painéis da série "Fire Sys"	980163200	166,00€
A-986	Bateria chumbo-ácido Pb 12V/ 7Ah	603001270	48,00€

KIT DE DETEÇÃO DE INCÊNDIO BS-1619



Este KIT contém todos os dispositivos necessários para instalar um pequeno sistema de detecção de incêndio em áreas limitadas (lojas pequenas, casas). O kit BS-619 contém:

- Painel de detecção de incêndio convencional BS 1632.
- Bateria A-986, para painel.
- Detector óptico de fumo com base BS-655.
- Detector termodiferencial com base BS-660.
- Botoneira manual BS-536.
- Sirene com sinalizador BS-531.

KIT DETEÇÃO DE INCÊNDIO SET BS-1619

MODELO	DESCRIÇÃO	CÓDIGO	PREÇO
BS-1619	Kit de detecção de incêndio	921619000	409,00€



Alimen.18-30VDC(fumo,temperatura)11-30V DC (gás)
Indicador de activação em LED
Relés de activação(detecores de gás)

Produzido de acordo com a norma europeia EN 54
Temp.func.-20 a 60°C(-20 a 90°C BS-660-661-668)
Humidade: até 95% de humidade relativa

BS-655, Detecor óptico de fumo (ou detecor de partículas de fumo) é activado quando a taxa de obscurecimento causada pelo fumo exceder 3% por metro.
BS-660. Detecor de calor com base.

BS-661. Detecor calor estanque (IP 65).
BS-657, Detecor de dupla tecnologia, pode ser usado para monitorizar uma área de 23-30 metros quadrados.



DETECTORES DE FUMO, TEMPERATURA E GÁS



MODELO	DESCRIÇÃO	CÓDIGO	PREÇO
BS-655	Detecor óptico de fumo com base	921655000	29,50€
BS-657	Detecor de fumo e termodiferencial com base	921657000	92,50€
BS-660	Detecor termodiferencial com base	921660000	49,50€
BS-668	Detecor de temperatura 60 °C com base	921668000	50,50€
BS-668/90	Detecor temperatura com base	921668090	50,50€
BS-659	Detecor de chama com base	980165900	150,50€
Base-6024	Base com relé 24V para BS-655,BS-657,BS-660,BS-668	927600001	47,50€



DETECTORES DE FUMO, TEMPERATURA E GÁS ESTANQUES



MODELO	DESCRIÇÃO	CÓDIGO	PREÇO	IP 65
BS-661	Detecor termodiferencial estanque (IP 65)	921661000	81,50€	
BS-658	Detecor monóxido carbono estan.(IP 65),11-30VDC (capac. p/ligação dupla)	980165800	508,50€	
BS-685	Detecor LPG estanque (IP 65), com relé 10V-30DC	921685000	132,50€	
BS-686	Detecor gás estanque (IP 65), gás natural com relé 10V-30DC	921686000	132,50€	

DETECTORES FUMO E CALOR ANTI-EXPLOSIVO



MODELO	DESCRIÇÃO	CÓDIGO	PREÇO
BS-655/Ex	Detecor óptico de fumo anti-explosivo	980165500	810,00€
BS-660/Ex	Detecor termodiferencial anti-explosivo	980166002	716,00€

O detecor BS-668 é activado quando a temperatura da área monitorizada é superior a 60°C. Pode ser usado para monitorizar uma área de cerca de 50 metros quadrados.

BS-685 detecor estanque (IP65) com relé, é activado quando o teor de gás (propano e butano) na área monitorizada ultrapassa 5-15% do nível inferior de explosividade (L.E.L). O LED incorporado acende quando o detecor é activado. O comando é dado com um relé de contacto.

A base 6024 tem um relé incorporado que é activado quando o detecor emite um alarme. Pode ser usada para controlar dispositivos (sirenes) que devem ser activados em caso de alarme.

SIST. DET. INCÊNDIO ANALÓGICO ENDEREÇÁVEL

CONTROLO DETEÇÃO INCÊNDIO ENDEREÇÁVEL

PAINEL 1 A 8 LOOP da série "ADDRESS FIRE"



olympiaTM
electronics

SAFETY & SECURITY SYSTEMS

PAINEL CONTROLO DET. INC. ANALÓGICO ENDEREÇÁVEL 1 A 8 LOOP da série "ADDRESS FIRE"

MODELO	DESCRIÇÃO	PREÇO
BSR-2104	Painel deteção inc.endereçável analógico 2 loops/96 zonas	3550,00€
BSR-2114	Painel deteção inc. endereçável analógico 4 loops/96 zonas	5165,00€

MODELO	DESCRIÇÃO	PREÇO
BSR-2140	Dispositivo de expansão c/2 loops p/painel endereçável BSR-21XX	1601,00€
BSR-2141	Dispositivo de expansão c/ 4 loops p/painel endereçável BSR-21XX	2328,00€
BSR-2142	Impressora térmica para BSR-21XX	875,00€
BSR-2000	Painel repetidor para BSR-21XX	1534,00€
BSR-8017	Unidade endereçável I/O	183,00€
BSR-5032	Sirene com farol endereçável IP 42	160,00€
BSR-5032/WP	Sirene endereçável com sinalizador estanque IP 65	190,00€
A-2100	Software e cabo USB para BSR-21xx	77,00€
BOX-2100/WP	Caixa metálica estan. p/painel det. incêndio BSR-2104 & BSR-2114	1345,00€



PROGRAMA ESPECIALIZADO PARA TRATAMENTO SISTEMAS DETECÇÃO DE FOGO POR UM PC.

A série CMI inclui programas para funcionamento independentes e suporta painel individual ou de rede.
A série BMS inclui os programas necessários para operar o sistema com um edifício central de gestão.

Software BMS & CMI para painéis BSR-2104 & BSR-2114

MODELO	DESCRIÇÃO	PREÇO
BMS-1001	Software básico para ligação BSR-2xxx com Porta	S/CONSULTA
BMS-1204	Software para ligação BSR-21xx com protocolo BACnet	S/CONSULTA
BMS-1202	Software para ligação BSR-21xx com protocolo Modbus I	S/CONSULTA
BMS-1203	Software para ligação BSR-21xx com protocolo OPC	S/CONSULTA
CMI-1001	Software monitor BSR-21xx	S/CONSULTA
CMI-1202	Modbus protocolo para CMI-1001	S/CONSULTA
CMI-1203	OPC protocolo para CMI-1001	S/CONSULTA
CMI-1204	BACnet protocolo para CMI-1001	S/CONSULTA
BMS-485	Dispositivo para ligação BSR-21xx com um PC	S/CONSULTA



PAINEL DET. INCÊNDIO ENDEREÇÁVEL 1 LOOP série «ADDRESS FIRE»

O painel de deteção de incêndio BSR-1116 é fabricado com as normas Europeias EN 54-2 e EN 54-4. É apropriado para médias e grandes instalações como hotéis, centros comerciais e fábricas. Cada dispositivo ligado ao painel possui o seu próprio endereço e um nome com 16 caracteres que é definido pelo utilizador. O loop do painel pode aceitar até 150 dispositivos endereçáveis e capacidades de conexão de dispositivo convencional. Todos os dispositivos podem ser divididos em 16 zonas sem qualquer restrição. O painel possui 2 saídas independentes para sirene programáveis, onde poderão ser ligadas sirenes e campainhas convencionais.

BSR-8018. Unidade entrada-saída endereçável. Possui uma entrada que é monitorizada para condições de circuito aberto e curto-circuito e uma saída de relé de 1A/30V totalmente programável a partir do painel. Podem ser ligadas ao loop até 16 destas unidades. Cada unidade ocupa 2 endereços, um para entrada e outro para o relé.

BSR-5031. Sirene de incêndio endereçável com sinalizador. Estas sirenes são alimentadas pelo loop e cada loop pode aceitar até 16 sirenes.

BSR-6558. Impressora térmica apropriada para ligação com o painel endereçável BSR-1116.



PAINEL DE DETEÇÃO DE INCÊNDIO COM 1 LOOP da série "ADDRESS FIRE"

MODELO	DESCRIÇÃO	PREÇO
BSR-1116	Painel deteção incêndio endereçável c/1 loop analógico, 16 zonas	1711,00€
BSR-5031	Sirene de incêndio endereçável com sinalizador, 100dB	163,00€
BSR-5031/WP	Sirene incêndio endereçável estanque IP65,c/sinalizador 100dB	190,00€
BSR-6558	Impressora térmica para BSR-1116	1308,00€
BSR-8018	Unidade entrada / saída endereçável com relé auxiliar	184,00€
A-1100	Software para BSR-1116 e cabo USB	77,00€





DISPOSITIVOS DE DETEÇÃO DE INCÊNDIO ENDEREÇÁVEIS COMPATÍVEIS COM OS PAINÉIS

BSR-2104, BSR-2114 & BSR-1116

BSR-6055/A. Sensor óptico de fumo endereçável. Possui uma câmara interna «inteligente» com um transmissor e receptor especiais. O sensor envia continuamente informação digital ao painel sobre a quantidade de fumo. O painel, utilizando algoritmos especiais, decide quando emitir o alarme. O sensor possui uma base de ligação especial e micro-interruptores que são utilizados para definir o endereço.

BSR-6057/A. Detector óptico de fumo endereçável / detector termodiferencial. (A mesma base do BSR-6055A)

BSR-6060/A. Sensor termodiferencial endereçável. Possui um sensor especial de temperatura que oferece uma saída dependendo da temperatura da área monitorizada. O micro processador incorporado calcula a taxa de aumento da temperatura e envia informação digital ao painel. O sensor possui uma base de ligação especial e micro-interruptores que são utilizados para definir o endereço.

BSR-5036/A. Botoneira endereçável. Quando activada, esta botoneira informa o painel da precisa localização da ocorrência e em simultâneo acende o

LED incorporado. Possui micro-interruptores que são utilizados para definir o endereço.

BSR-8013/A. Controlador endereçável para dispositivos convencionais. Esta unidade permite que o sistema aceite uma nova zona ou pré-instalação de sensores convencionais e botoneiras. Quando o painel emite um comando «Sirene Silence» o BSR-8013/A e o sensor que emitiram o alarme permanecerão activados para que sejam facilmente encontrados. Um comando «Reset» reporá os sensores no seu funcionamento normal. Cada loop pode aceitar até 10 dispositivos.

BSR-8019/A. Unidade endereçável de entrada com relé. É utilizada para ligar detectores de gás (ex. BS-685 e BS-686) no loop. Possui uma entrada que é completamente monitorizada para condições de circuito aberto e curto-circuito, e um relé (1A/30V) activado após o reset no painel.

BSR-7070/A. Isolador de linha. É colocado entre outras unidades endereçáveis e isola qualquer curto-circuito que possa acontecer nos cabos. Até 32 destes dispositivos podem ser conectados no loop.

DISPOSITIVOS DE DETEÇÃO DE INCÊNDIO ENDEREÇÁVEIS



Base-6024/SB

MODELO	DESCRIÇÃO	CÓDIGO	PREÇO
BSR-5036/A	Botoneira endereçável	921503602	94,00€
BSR-5036/A/WP	Botoneira endereçável estanque IP 65	921503603	158,00€
BSR-5072	Detector remoto LED (vermelho)	921507200	26,00€
BSR-6055/A	Sensor óptico de fumo endereçável	921605502	94,00€
BSR-6057/A	Detector endereçável óptico fumo/detector termodiferencial	921605700	101,00€
BSR-6060/A	Sensor termodiferencial endereçável	921606002	86,00€
BSR-7070/A	Isolador de linha endereçável	921707001	155,00€
BSR-8013/A	Controlador endereçável de detector convencional	921801301	193,00€
BSR-8019/A	Unidade endereçável de entrada com relé	921801901	193,00€
Base-6024/SB	Base para detector endereçável com sirene e farol	921602400	71,00€
BSR-7071/A	Isolador de linha endereçável com base	921707100	79,00€

BSR-5036/A



ACESSÓRIOS PERIFÉRICOS

MODELO	DESCRIÇÃO	CÓDIGO	PREÇO
A-485	Amplificador de sinal para RS-485	980148500	1076,00€

BSR-5036/A/WP



BSR-6055/A



BSR-6057/A
BSR-6060/A



BSR-7071/A



A-485



BSR-7070/A



olympiaTM
electronics

SAFETY & SECURITY SYSTEMS

DISPOSITIVOS PERIFÉRICOS DETEÇÃO INCÊNDIO



DISPOSITIVOS DE AVISO E INDICAÇÃO PARA SISTEMAS DE DETEÇÃO DE INCÊNDIO

MODELO	DESCRIÇÃO	CÓDIGO	PREÇO
BS-528	Sinalizador de alarme	921528000	93,00€
BS-527	Armadura indicação escrava com besouro 12-24VDC	921527000	57,00€
BS-542	Sirene com sinalizador, 100dB (para BS-690, BS-691)	921542000	42,00€
BS-554	Megafone, sirene e sinalizador para BS-620	921554000	98,00€
BS-572	Detector remoto LED (vermelho)	921572000	18,00€
BS-576	Sinalizador com lâmpada incandescente	921576000	41,00€
BS-578	Sinalizador 12V DC com lâmpada XENON	921578000	75,00€
BS-579	Sinalizador 24V DC com lâmpada XENON	921579000	76,00€
BS-595	Campainha 6" para painéis de detecção de incêndio	921595000	65,00€



Etiqueta incluída
na embalagem
da BS-527

STOP

BS-530/W, BS-530. Sirene (IP 42) para painéis de detecção de incêndio
Tensão trabalho: 24 - 30 VDC.
4 LEDs de alto rendimento.

BS-531/WP, BS-531. Sirene com sinalizador (IP 42) para painéis de detecção incêndio.
Tensão trabalho: 24 - 30V DC.
4 LEDs de alto rendimento.

MODELO	DESCRIÇÃO	CÓDIGO	PREÇO
BS-530	Sirene para painéis de detecção incêndio, 100dB, IP 42	921530000	57,00€
BS-531	Sirene com sinalizador p/painéis de detecção incêndio, 100dB, IP 42	921531000	55,00€
BS-530/WP	Sirene estanque para painéis de detecção de incêndio, 100dB IP65	921530003	66,00€
BS-531/WP	Sirene estanque c/sinalizador p/painéis detecção incêndio 100dB IP65	921531003	69,00€

BS-97, BS-98, BS-99. Estes dispositivos possuem um LED que pisca cada 8 segundos. Quando o detetor é ativado o besouro interno toca. Estes dispositivos podem ser instalados em escritórios, quartos, cozinhas, corredores, etc. Pode monitorizar uma área de cerca de 50m2.

MODELO	DESCRIÇÃO	CÓDIGO	PREÇO
BS-97	Detetor ótico de fumo 230V AC	980097000	28,50€
BS-98	Detetor ótico de fumo com bateria de 9V	980098000	28,00€
BS-99	Detetor ótico de fumo com dupla voltagem 230V AC, com bateria 9V	980099000	34,90€





BS-419/KIT



Central Alarme

MODELO	DESCRIÇÃO	PREÇO
BS-419/KIT	Central de Intrusão	380,00€

BS-468/KIT



Central Alarme

MODELO	DESCRIÇÃO	PREÇO
BS-468/KIT	Central de Intrusão	465,00€

Detetores

MODELO	DESCRIÇÃO	PREÇO
BS-405	Detetor Movimentos IR	50,00€
BS-409	Detetor Movimentos IR / Micro ondas	110,00€
BASE-401	Base para Detetor BS-405 e BS-409	6,00€
BS-360	Detetor Tecto 360° IR	87,00€
BS-660	Detetor Temperatura	50,00€
BS-655	Detetor ótico Fumos com base	30,00€
LD-12	Detetor	95,00€

Daylight

iluminação

Add: Rua Moçambique, Nº 230
Zona Industrial Ovar

P.C. 3880-106 Ovar - Portugal

Tel. 00351 256 579 250

Fax 00351 256 579 259

E-mail: geral@soflight.com

Http:// www.soflight.com